



# Viz Multiplay User Guide

Version 3.0





**Copyright © 2020 Vizrt. All rights reserved.**

No part of this software, documentation or publication may be reproduced, transcribed, stored in a retrieval system, translated into any language, computer language, or transmitted in any form or by any means, electronically, mechanically, magnetically, optically, chemically, photocopied, manually, or otherwise, without prior written permission from Vizrt. Vizrt specifically retains title to all Vizrt software. This software is supplied under a license agreement and may only be installed, used or copied in accordance to that agreement.

### **Disclaimer**

Vizrt provides this publication “as is” without warranty of any kind, either expressed or implied. This publication may contain technical inaccuracies or typographical errors. While every precaution has been taken in the preparation of this document to ensure that it contains accurate and up-to-date information, the publisher and author assume no responsibility for errors or omissions. Nor is any liability assumed for damages resulting from the use of the information contained in this document. Vizrt’s policy is one of continual development, so the content of this document is periodically subject to be modified without notice. These changes will be incorporated in new editions of the publication. Vizrt may make improvements and/or changes in the product(s) and/or the program(s) described in this publication at any time. Vizrt may have patents or pending patent applications covering subject matters in this document. The furnishing of this document does not give you any license to these patents.

### **Technical Support**

For technical support and the latest news of upgrades, documentation, and related products, visit the Vizrt web site at [www.vizrt.com](http://www.vizrt.com).

### **Created on**

2020/10/23

# Contents

<b>1</b>	<b>Introduction.....</b>	<b>8</b>
1.1	System Overview.....	9
1.1.1	Viz Multiplay.....	9
1.2	Glossary .....	10
<b>2</b>	<b>Installation and Configuration.....</b>	<b>11</b>
2.1	Viz Multiplay Installer .....	11
2.2	Licensing .....	11
2.3	Configuring Clients.....	12
2.3.1	Viewing in a Browser.....	12
2.3.2	Connecting to Media Sequencer.....	13
2.3.3	Configuring Asset Search in Viz One .....	13
2.4	Video Wall Configuration .....	14
2.4.1	Getting Started with a Video Wall Setup.....	14
2.4.2	Screens with Different Sizes and Resolutions .....	16
2.4.3	External Preview .....	16
2.4.4	Using Datapath Fx4 .....	18
2.4.5	Working with Superchannels .....	24
2.4.6	Working with GFX Channels .....	33
2.5	Configuring Workspaces .....	35
2.5.1	Hiding Channels .....	36
2.5.2	Shortcuts per Workspace .....	37
2.6	Configuring the User Interface .....	38
2.6.1	Layout Options .....	38
2.6.2	Toolbar.....	38
2.6.3	Hide Sources Pane and Show pane.....	38
2.6.4	New and Open .....	39
2.6.5	Settings .....	39
2.6.6	1-Tap Mode .....	39
2.6.7	Cleanup and Initialize .....	39
2.6.8	On Air Mode .....	40
2.6.9	Tablet Set-up .....	40
2.6.10	Resizing and Collapsing Channels.....	40
2.7	Settings .....	42
2.7.1	General.....	43
2.7.2	Profiles .....	46

2.7.3	Workspaces .....	49
2.7.4	Inboxes .....	52
2.7.5	Servers .....	53
2.7.6	Color Correction .....	54
<b>3</b>	<b>Workflows .....</b>	<b>62</b>
3.1	The Journalist .....	62
3.2	The Control Room Operator .....	63
3.3	The Presenter .....	63
3.4	Importing Graphics .....	63
3.4.1	Basic Scene Import .....	64
3.5	Setting Up and Organizing Content .....	67
3.5.1	Using Custom Thumbnails for Media Elements .....	68
3.5.2	Setting Up a Preview Server .....	68
3.5.3	Working With Shows and Profiles .....	70
3.5.4	Shortcuts .....	72
3.5.5	Working with Graphics .....	73
3.5.6	Inboxes .....	74
3.5.7	Working with Images and Videos .....	75
3.5.8	Edit Graphics, Videos and Images .....	77
3.6	Preparing and Playing Out Content .....	80
3.6.1	Preparing Content .....	80
3.6.2	Cleaning up the Renderer .....	83
3.6.3	Playing out Content .....	84
3.6.4	Transitioning Content between Armed and Program .....	85
3.6.5	Auto-playlist .....	86
3.7	Working with Filled Presets .....	87
3.7.1	For Dynamic Walls, Presets with GFX Channels Are .....	87
3.7.2	For Video Walls with Superchannels, Presets Are .....	88
3.7.3	Common Workflow .....	88
3.7.4	Adapt the GUI for Pre-filled Walls .....	90
3.7.5	The Preset Content Editor .....	91
3.8	Working with Viz Pilot and MOS Content .....	92
3.8.1	Definitions .....	93
3.8.2	To Add a Playlist .....	93
3.8.3	Viz Pilot Playlists .....	93
3.8.4	The MOS Workflow .....	93
3.8.5	Pilot Data Server .....	96

3.9	Using a Switcher .....	98
3.9.1	Background .....	98
3.9.2	Configuring the Media Sequencer .....	99
3.9.3	Learning Elements .....	100
3.9.4	Recalling and Trigger .....	102
3.10	Using Graphic Hub Image Staging .....	103
3.10.1	Required Components .....	103
3.10.2	Configuration and Setup .....	103
3.10.3	Workflow in Viz Multiplay .....	104
3.11	Tips and Tricks .....	106
3.11.1	Filling Clips/Images in GFX Channels instead of Letterboxing .....	106
3.11.2	Enabling Transitions between Video Clips .....	107
3.11.3	Tips and Tricks for Viz Engine 3.8.2 or Later .....	110
3.11.4	Tips and Tricks for NVIDIA Mosaic .....	110
3.11.5	Performance Issues .....	110
3.12	Editing Graphics, Videos and Images .....	112
3.12.1	Editing Images .....	112
3.12.2	Editing Videos .....	114
3.12.3	Editing Graphics .....	116
3.12.4	Editing Presets .....	122
3.12.5	Renaming Playlist Entries .....	126
3.13	Arming and Taking Elements .....	127
3.13.1	Media Pane .....	127
3.13.2	Armed .....	131
3.13.3	Program .....	132
3.13.4	Arm and Take Multiple Elements .....	134
3.13.5	Reload Scene .....	135
3.14	Organizing Media Content .....	136
3.14.1	Browse Shows Window .....	136
3.14.2	Show Pane .....	138
3.14.3	Locating Page Lists, Playlists and Groups .....	138
3.14.4	Add, Delete or Rename a Group .....	139
3.14.5	Move Groups to Other Playlists in the Show Pane .....	140
3.14.6	Add a New Playlist .....	141
3.14.7	Working with Playlists .....	142
3.15	The Sources Pane .....	144
3.15.1	Media Tab .....	144

3.15.2	Inbox Tab .....	147
3.15.3	GFX Tab .....	148
3.15.4	Video Walls Tab .....	150
3.15.5	Dynamic Walls Tab .....	152
3.15.6	Templates Tab .....	154
3.16	Using Shortcuts .....	159
3.16.1	Elements in the Shortcuts Bar .....	160
3.16.2	Layers .....	163
3.16.3	Working with the Shortcuts Bar .....	163
3.16.4	GFX Preset Mode .....	164
<b>4</b>	<b>The User Interface .....</b>	<b>168</b>
4.1	Overview of the Interface .....	168
4.2	Status and Logs .....	169
4.2.1	Status Bar .....	169
4.2.2	Logs .....	169
4.2.3	Version Information .....	169
4.3	Keyboard Shortcuts .....	170
4.3.1	Main Window .....	170
4.3.2	Profile Configuration .....	172
4.3.3	Video Editor .....	172
4.3.4	Workspaces .....	173
4.3.5	Video Wall Designer .....	173
4.4	Video Wall Designer .....	174
4.4.1	Superchannels-based Video Walls .....	174
4.4.2	Dynamic Channel-based Video Walls .....	174
4.4.3	Video Wall Designer Layout .....	176
4.4.4	Channel Bin .....	178
4.4.5	Presets Bin .....	178
4.4.6	Channel Details .....	179
4.4.7	Channel Layout Editor .....	180
4.4.8	Active Areas Editor .....	183
<b>5</b>	<b>Troubleshooting and Known Issues .....</b>	<b>186</b>
5.1	Troubleshooting .....	186
5.1.1	The Viz Engine Output Keeps Going Black Randomly .....	186
5.1.2	When I Run Viz Engine in Fullscreen My Graphic Quality Downgrades to SD .....	186
5.1.3	Video Transfer from a Search Result to a GFX Channel Stays on 0% .....	186
5.1.4	Video Transfer from a Search Result Gives Errors .....	186

5.1.5	The Search Panel Looks Disabled and It Returns an Error about Viz One.....	187
5.1.6	My Clips/Graphics do not Appear on the Output Engines when I Put Them On Air.....	187
5.1.7	No Thumbnails for My Graphics Appear in Viz Multiplay .....	187
5.1.8	The Show Opens but Doesn't Display Any Stories or Content .....	187
5.1.9	I Have Set up Profiles but Get an Error about No Viz/Video Program .....	187
5.1.10	Problems Running Preview Server.....	187
5.2	Known Issues in Viz Multiplay .....	188
5.3	Performance Issues .....	188
5.3.1	DynamicChannel Scene .....	188
5.3.2	Video Wall Setup .....	188
5.3.3	Background Loading of Images (Performance).....	189
5.3.4	Requirements .....	189
5.3.5	Preparation of Images in Graphic Hub .....	189
<b>6</b>	<b>FAQs.....</b>	<b>190</b>
6.1	How do I set up a video wall with screens with different aspects and resolutions? .....	190
6.2	Does Viz Multiplay support clips with non broadcast format? .....	190
6.3	Can I use Viz Pilot instead of Viz Trio? .....	191
6.4	What is the technical limitation of playing HD clips? .....	191
6.5	Does the playlist update after changes in the newsroom system rundown? .....	191
6.6	Can Viz Multiplay play out graphics created via Viz Pilot templates?.....	191
6.7	Can Viz Multiplay open a playlist from Viz Pilot? .....	191
6.8	Can Viz Multiplay open a MOS rundown? What is the workflow? .....	191
6.9	How do I run movie clips? .....	192
6.10	Can we have live input in one of the monitors or across a group? .....	192
6.11	Can I use a touch screen monitor in my live-to-air control room?.....	192
6.12	Can Viz Multiplay be controlled by Viz Mosart, VDCP, Viz Trio or Viz Pilot? .....	192
6.13	Can Viz Multiplay be integrated into a Mosart workflow?.....	192
6.14	Can we use Social TV as a source for Viz Multiplay? .....	192
6.15	Do I need a Viz One to feed Viz Multiplay with clips and images? .....	193

---

# 1 Introduction

Viz Multiplay is a powerful tool for controlling studio screen content. The simple interface can be used in the control room or by the presenter in the studio.

- Send content quickly to multiple screens.
- Dynamic control from a single interface.
- Control live, video, graphics and still images.
- Build playlists and full content editing.





## 1.1 System Overview

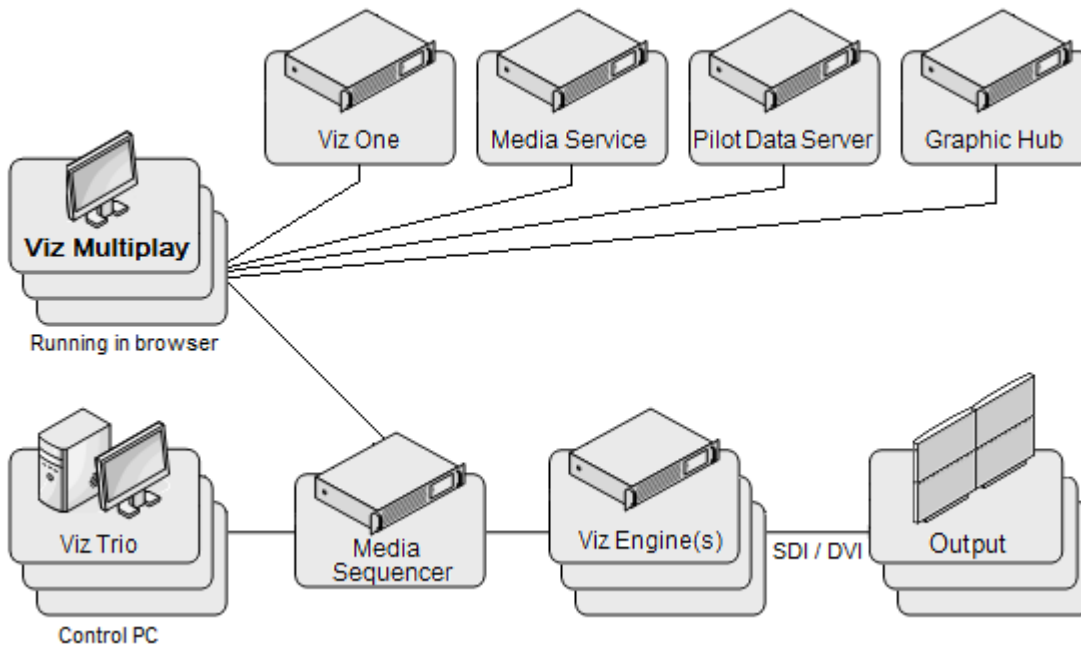

### 1.1.1 Viz Multiplay

- Is compatible with graphics from **Viz Trio** and **Viz Template Wizard**. Shows from Viz Trio are available in Viz Multiplay.
- Can access and use templates and elements in a **Pilot Data Server**.
- Is hosted on a URL on the **Media Sequencer**. Any number of clients can connect to the same Media Sequencer, which provides the scheduling for playback.
- Uses **Viz Engines** for playback:
  - The video wall feature allows up to four DisplayPort outputs with UHD resolution from a single GPU in a Viz Engine. With Datapath Fx4 display controllers, the number of outputs can be increased to match numerous screens and panels of different shapes and orientations.
  - Also supports Standard SDI-based playback.
- Can access media assets stored in **Viz One** and **Media Service**.
- Can open MOS playlists.

**⚠ Note:** It's recommended to check the performance of scenes when using complex configurations.

---

## 1.2 Glossary

The following terms are used in this manual:

- **Arm:** Armed means that an element is ready for play-out. When 1-tap mode is off, elements are sent to the **arm column**.
- **Channel:** One or more Viz Engine connections. Typically either a Viz output, a video output, or both.
- **Channels:** Each wall contains one main channel and multiple additional channels that can be freely moved and resized. Channels contain images, videos or Viz Artist scenes.
- **Layout:** A unique arrangement of channels within a preset. You can save multiple layouts for a show and design layouts for a specific look (for example a morning and evening show). Layouts can be used by more than one preset.
- **Main channel:** The Viz output on which video wall presets are run. This is normally host: 6100. Only presets and backgrounds should be taken on this channel.
- **Preset:** A pre-defined set of one or more layouts of channels on a video wall. Presets are Viz Artist scenes played out on the main channel.
- **Profile:** A defined set of playout channels and video walls.
- **Show:** A Viz Trio compatible data structure on the Media Sequencer that describes a set of elements (graphics, videos, images) and playlists.
- **Video wall:** The physical layout of a display or set of screens. Each wall belongs to a single profile. The layout (rows, columns, screen dimensions, bezels) must match the NVIDIA Mosaic setup.
- **Workspace:** The user interface that can be customized for each individual user. For example, you can hide channels that are not needed by an anchor.

---

## 2 Installation And Configuration

This section covers:

- [Configuring Clients](#)
- [Video Wall Configuration](#)
- [Configuring Workspaces](#)
- [Configuring the User Interface](#)
- [Settings](#)

**⚠ Note:** Media Sequencer must be installed on the computer hosting Viz Multiplay.

**⚠ Note:** Read the Video Wall Configuration section in the [Viz Engine manual](#) to ensure that your setup is working properly before considering the other required components. See the Release Notes for information and recommendations on components and versions.

---

### 2.1 Viz Multiplay Installer

**⚠ Note:** A Viz Multiplay licensed Media Sequencer dongle is required on the server machine. See [Licensing](#) below.

- On the Media Sequencer machine, run the Viz Multiplay installer file `VizMultiplay-[version].exe`. This will install the core files for Viz Multiplay, including documentation, and will add shortcuts to the desktop and Start menu which point to the application's URL.
- The default installation location is: `<MEDIA_SEQUENCER>\www\app\vizmultiplay`, e.g. `%Program Files%\Vizrt\Media Sequencer\www\app\vizmultiplay`.
- The default location is recommended, but can be configured if required.

**⚠ Note:** Media Sequencer must be running before installation, since Media Sequencer acts as a web server for Viz Multiplay.

---

### 2.2 Licensing

Viz Multiplay requires a Viz Multiplay-licensed Media Sequencer dongle on the server machine. If a valid license is not present, a warning message appears when the Viz Multiplay client is started, and every 20 minutes thereafter.

---

## 2.3 Configuring Clients

This section covers the following topics:

- [Viewing in a Browser](#)
- [Connecting to Media Sequencer](#)
- [Configuring Asset Search in Viz One](#)

### 2.3.1 Viewing in a Browser

The URL to access Viz Multiplay is: `<ms_host>:8580/app/vizmultiplay/vizmultiplay.html`.

#### Desktop

The latest version of Chrome, Firefox or Safari is recommended for running on a desktop.

#### Touch Screen

Firefox is recommended, as it fully supports touch screen drag-and-drop functionality.

**⚠ Note:** The recommended minimum screen resolution is 1280 x 720.

#### Tablets

The interface adapts automatically to smaller screens such as tablets.



## 2.3.2 Connecting to Media Sequencer

Viz Multiplay and other control clients (e.g. Viz Trio) must be connected to the same Media Sequencer (MSE) in order to share a show. Viz Multiplay can be hosted on one Media Sequencer and connected to the content of a second Media Sequencer by adding the URL parameter `mse=<host>` to the URL:

```
<ms_host>:8580/app/vizmultiplay/vizmultiplay.html?mse=<mse_hostname>
```

**Note:** Media sequencer stores all playlists and shows and makes them available to all control applications connected to it.

## 2.3.3 Configuring Asset Search in Viz One

**Note:** If you need help configuring Viz One, please contact your local Vizrt customer support team at [www.vizrt.com](http://www.vizrt.com).

Once Viz Trio is configured to work with Viz One, the Viz Multiplay integration is straightforward. Follow the steps below to enable asset search from Viz Multiplay:

### Viz One Login

A Viz One account is required in order for Viz Multiplay to log in. Viz Multiplay can use the same account as Viz Trio. If it is a separate account, it must have the same access rights as the one used by Viz Trio.

**Note:** Viz Multiplay runs in a web browser, which handles authentication. The user must therefore enter a username and password in a dialog box provided by the browser, which caches these credentials.

To configure Viz One in Viz Multiplay:

1. Go to **Settings > Servers**.
2. Enter the hostname in the Viz One input box and press TAB. Viz Multiplay fills in the rest of the URL.

To configure Viz One in Viz Trio:

1. Open Viz Trio.
2. Select **Configuration > Viz One** and enter the Service Document URL, username and password.

### Internet Explorer Settings

If you're using Internet Explorer, you must allow cross-origin requests (automatically supported in Chrome and Firefox).

1. Open Internet Explorer.

2. Select **Tools > Internet Options > Security > Custom Level**.
  3. Browse down to **Miscellaneous**, click **Enable for Access data sources across domains**.
- 

## 2.4 Video Wall Configuration

This section covers creating a profile and setting up and configuring video walls that represent the physical screen setup at the location. Using a separate Viz Engine as an external preview for the video wall is also covered.

A profile can conceptually be seen as a studio, or a physical location where you want to control content on a set of screens. The profile can have one or more video walls that can be controlled individually.

This section covers the following topics:

- [Getting Started with a Video Wall Setup](#)
- [Screens with Different Sizes and Resolutions](#)
- [External Preview](#)
- [Using Datapath Fx4](#)
- [Working with Superchannels](#)
- [Working with GFX Channels](#)

### 2.4.1 Getting Started with a Video Wall Setup

This section covers how to get started setting up a video wall without using an external video wall display controller. If you use one or more display controllers, for instance Datapath Fx4.

This section covers the following topics:

- [Dynamic Channels and Superchannels](#)
  - [Should I Use Dynamic Channels or Superchannels?](#)
  - [Set up a Profile and Video Wall](#)

### Dynamic Channels and Superchannels

Viz Multiplay supports two video wall mechanisms:

- The **Dyanamic Channels** solution based on one Viz Multiplay specific Viz Artist scene containing GFX channels.
- The **Superchannels** solution based on Superchannels where each video wall is represented in a user-designed Viz Artist scene (for Viz Multiplay 3.0 and above). See the release notes for the required version of Viz Engine.

### Should I Use Dynamic Channels or Superchannels?

#### New Installations

Select the **Superchannels** mechanism. This will allow:

- Better performance
- A/B workflow with content transitions
- Custom transitions between presets (layouts)

## Existing Installations

If you need to support an existing workflow that contains more than eight video wall regions (GFX channels), or if you need quick, offline creation of presets in the video wall designer - stay with the Dynamic Channels solution.

## Set up a Profile and Video Wall

To get started, you will need a profile. A profile is a collection of playout resources. One profile may contain references to one or more physical video walls.

1. Click **Settings > Profiles**.
2. Create a profile by clicking the **Add (+)** button in the bottom of the Profiles list.
3. Enter a name for the new profile.
4. Select whether you want to create a Dynamic Channels wall or a Superchannels wall and click the **Add (+)** in the bottom of the list.
5. Enter a name for the video wall, and **hostname** of the Viz Engine driving the video wall (NB! The Viz Engine must be in On Air mode and reachable through the network when creating a new video wall) how many virtual channels (video wall areas) you need to use.

**New Video Wall Setup**

Name : Video Wall

Engine : localhost ✓

Asset Storage : (No Storage) | ▾

External Preview : (None) | ▾

Channels : 8 | ▾

---

Graphic Hub host : localhost ↻

Graphic Hub user : Guest

Resolution : 1920 x 1080

OK Cancel

**⚠ Note:** Viz Engine supports up to 16 GFX channels and eight Superchannels. Do not enable more than you need. The number of channels does not need to match the total number of screens you have. Channels are virtual areas that can span over several screens.

6. If **Viz One** is configured, select the publishing point to where Viz One will transfer clips when dragged into a playlist in Viz Multiplay. The publishing point is the clip root of the Viz Engine - making sure that clips needed for playout are available on the physical Viz Engine hardware.
7. If a separate Viz Engine is used as video wall preview, select the preview video wall in **External Preview**. Everything that is Armed in Viz Multiplay will be taken first to the external preview engine. The preview engine can have any resolution, but it need to have the same aspect as the program engine.

In the bottom half of the window, the following information is shown, based on what Viz Multiplay reads out from the connected Viz Engine:

- The Graphic Hub host name and user name of the Viz Engine.
- The resolution of the Viz Engine.

The Graphic Hub info should match the global Graphic Hub settings in **Settings > Servers**. The resolution can be manually adjusted, or refreshed with the Refresh button. The resolution is used by Viz Multiplay to draw thumbnails and to display correct aspect of the wall and of the channels in the Video Wall Designer.

## 2.4.2 Screens with Different Sizes and Resolutions

The Nvidia Mosaic setup only supports output to an X \* Y matrix of screens with similar resolution. Nvidia also recommends that all the screens in a Mosaic video wall should be the same model. One GPU can provide four outputs. It's not recommended to add more GPUs to the computer.

**i** **Info:** The recommended way of combining more screens, and/or different aspects and resolutions, is to use an external video wall display controller, like Datapath Fx4.

The principle is that the Viz Engine draws all its output on one big renderer space, where the different areas are defined by the size and position of the virtual channels. On the hardware side, the output from the GPU (either combined or not combined with Nvidia Mosaic) fed into one or more display controllers distributes the pixels to the physical screens.

The screen layout given in Datapath Fx4 controllers can be imported into Viz Multiplay to create Active Areas (snap points) for the GFX channels when designing walls.

### See Also

- [Using a Datapath Fx4 Display Controller](#)

## 2.4.3 External Preview

Although the **Armed** column provides an indication of content that's ready to be played out, it's not an accurate preview. For an accurate Viz Engine preview of the content, you must configure preview on an external Viz Engine.

**w** **Note:** Depending on how much hardware you have available, the preview can be a simple VGA version of the Viz Engine (without clip playback), or a Video Engine with Matrox hardware for live input and clip playback.

Keep the following in mind:



- The Program and Preview engines can have different resolution, but need the same aspect.
- You can preview live sources if your preview engine is a video-enabled Viz Engine with a Matrox video card. The SDI in signals must then be split to go into both the video wall and the preview engine.
- Although mainly used for testing since its local preview function (reading pages) and the video wall preview will conflict, Viz Trio's local Viz preview can also be used as an external preview. The engines should have the same aspect.

**Info:** The data model behind the Viz Multiplay representation of the channels in the presets (the virtual areas of the video wall) used to communicate with Viz Engine is based on percent, even if the units in the GUI is pixels. This means that presets are compatible between a preview wall and a program wall with different resolutions. It also means that presets from one wall can be used on another video wall, as long as the aspect is the same.

## Setting Up and Using External Preview

To set up a video wall system with Program and Preview engines, two video walls need to be created in the Profile. First you need to create the preview wall:

1. Start the preview Viz Engine engine, configure the resolution and set it in On Air mode.
2. Click **Settings > Profiles**
3. Click on a profile and create a new video wall inside it.
4. This video wall will represent the preview wall.
5. Click **OK** to generate the channels for the preview wall.

**Note:** These channels will not be visible in the main playout GUI in Viz Multiplay.

6. Repeat the process for the Program Video Wall. Remember to start it and set it in On Air mode.
7. When creating the program video wall in the Profile - select your newly created preview wall in the **External Preview** combo box.

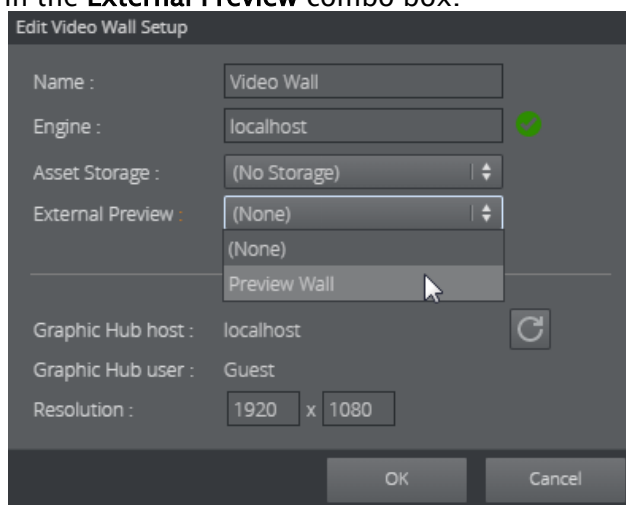

8. Click **OK**. Now, whenever you arm presets and elements (with 1-TAP mode disabled), these elements will be played out on the preview engine. The preview engine then acts as a “real” preview for the main wall, depending on what kind of hardware you use as a preview wall.
9. Go to **Settings > General**. Set the **Extra Armed button** to **CONTINUE**:



This makes an extra button appear in the **Armed** column. Whenever an element is armed, it is taken on the preview engine. Clicking **CONTINUE** now continues the element on the preview engine. In this way, you can preview a full sequence of stop points in a graphics on the preview engine before it is taken On Air in the program engine.

## 2.4.4 Using Datapath Fx4

When considering how to distribute the pixels from the Viz Engine output renderer to physical devices, there are numerous solutions. The two main solutions are using nVidia Mosaic and using the Datapath Fx4 MultiDisplay Controller. This section describes the usage of the Datapath device.

Viz Multiplay integrates with the [Datapath Fx4 MultiDisplay Controller](#):



In principle - the Viz Engine draws its output on a renderer surface with a resolution covering the complete output surface. From the renderer surface, it is possible to grab pixel areas and distribute them through one or more Datapath devices to physical outputs (screens). The first step of the configuration is to set up the physical mapping from the input signal to the physical screens. This is done with the software provided by Datapath. When this is done - the Datapath configuration file can be imported into Viz Multiplay and act as a backdrop when creating presets (video wall layouts).

In this section, we will go through a typical setup covering the following:

- [Connecting the Devices](#)
- [Calculating Resolution](#)
- [Setting up the Video Wall in Multiplay](#)

The details of the Datapath setup will not be covered here. Please consult the Datapath Fx4 manual.

### Connecting the Devices

The Datapath Fx4 device accepts up to 4K input through DisplayPort. There are different ways of utilizing one or more Datapath devices together with a Viz Engine. It is recommended to have one GPU from the nVidia Quadro series. These cards typically have 4 outputs. If the video wall needs more than a 4K resolution, two or more of the outputs from the GPU can be combined with nVidia Mosaic to create for instance an 8K surface. It is also possible to use Loop Through on the Datapath device to distribute the original signal unchanged to other outputs.

The Datapath devices can scale, duplicate or rotate any part of the input surface, so the output wall can have any aspect and resolutions. Rotation is only supported by 90 degrees.

**⚠ Note:** Needless to say - larger resolutions demands more powerful hardware. Have in mind what kind of content, which formats, how many clip and live channels, and the complexity of the graphics the Viz Engine should handle when scaling the wall to large resolutions.

In our typical setup, we connected two outputs from the GPU to each of the two Datapath devices through DisplayPort. We then connected 4 HD screens to each of the Datapath boxes. To control and configure the Datapath devices, we connected the boxes with USB to a separate PC on the network. We installed the Datapath Wall Designer software on this PC. The setup looked like this:

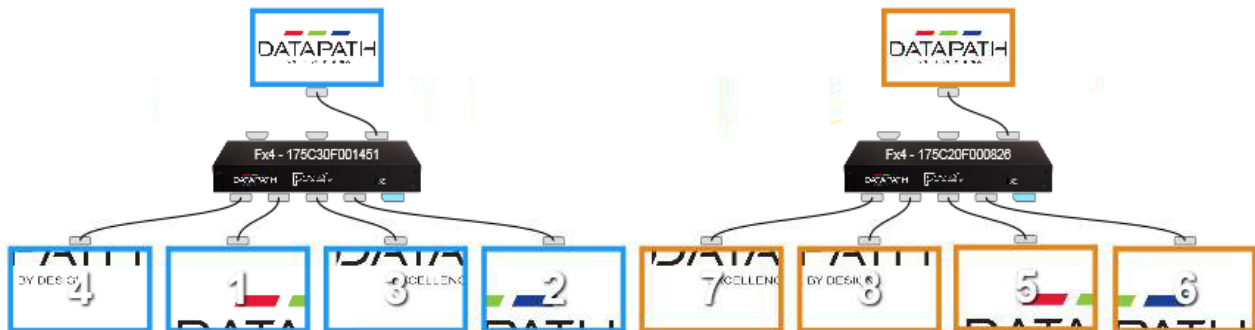

In this setup we use two 4K inputs from the GPU and distribute them to eight screens.

An alternative approach would be to settle for less input resolution and distribute one 4K input to the eight screens, using Loop-Through. In this way, if the output screens are HD (1920x1080), the HD screens will show scaled-up content from the 4K input. If this is an acceptable resolution on the output - it will give better performance.



## Using SYNC

To synchronize the output and input devices, it is vital to use a sync signal. The Fx4 must be genlocked to all external devices. Connect the external sync signal to each of the Datapath devices, to the nVidia GPU and the Matrox video card.

## Calculating Resolution

If your wall consists of one large surface without any bezel between screens, the input source resolution in the Datapath configuration can be set to match the wall resolution, given that the total resolution is under 4K (3840x2160). If the resolution of the wall is over 4K, and input resolutions need to be stitched together, each of the input resolutions are summed up to a total resolution, which is the resolution reported through nVidia Mosaic to the Viz Engine. This resolution can be seen in the *Output Format* section in Viz Engine Configuration.

- ✔ **Tip:** Even though the official limit of the **DisplayPort** input for each Datapath box is **4K/60fps** - this is a truth with modifications. The real limitation is the amount of data transmitted over the DisplayPort cable. This is limited by the DisplayPort standard "HBR2" which has a limit of 17.28 Gbit/s. This is enough for 4K/60 with 8bit per color. If the refresh rate is 50, the resolution can be slightly higher than 4K.

The bandwidth can also be affected by the cable length. Please consult the Datapath manual.

## Bezels

If the screens connected to a Datapath device has a frame around the active area - the distance between the screens should be encountered in the total input resolution. The distance contains invisible pixels that will be drawn by the Viz Engine renderer, but cut away by the Datapath box. There are two ways of taking bezels into account:

1. Set the input resolution to a total of 4K or whatever the Viz Engine should output. Then, to count for the distance disappearing between the screens, calculate how many pixels are left for each screen. Example: Input resolution is 4K (3840x2160). Output screens are HD (1920x1080). Now, there aren't enough pixels in the input resolution to fill each screen with full HD *and* cover the distance between the screens. You need to calculate how many pixels you have per cm in total and reduce the capture area available for the screens. The Datapath box will scale up the content to fill the screens. This method is hard to calculate and get correctly configured.
2. The easier way: Set the input resolution to higher than the total resolution of the screens to cover for the lost pixels. Calculate how many pixels you need to add to the input resolution (horizontal and vertical) to let the screens have their content in full resolution (1920x1080 for instance), and add the amount of pixels needed to cover the gap between the screens.

In our setup, we used method number 2. We found that we had to add about 170x192 pixels to the total resolution to cover for the pixels between the screens. So the total input resolution was 4000x2352. As we run in PAL (50Hz), we still are under the maximum bandwidth of the DisplayPort capacity. In this way - the capture regions for each screen is 1920x1080, and they are placed in the corners of the total surface.

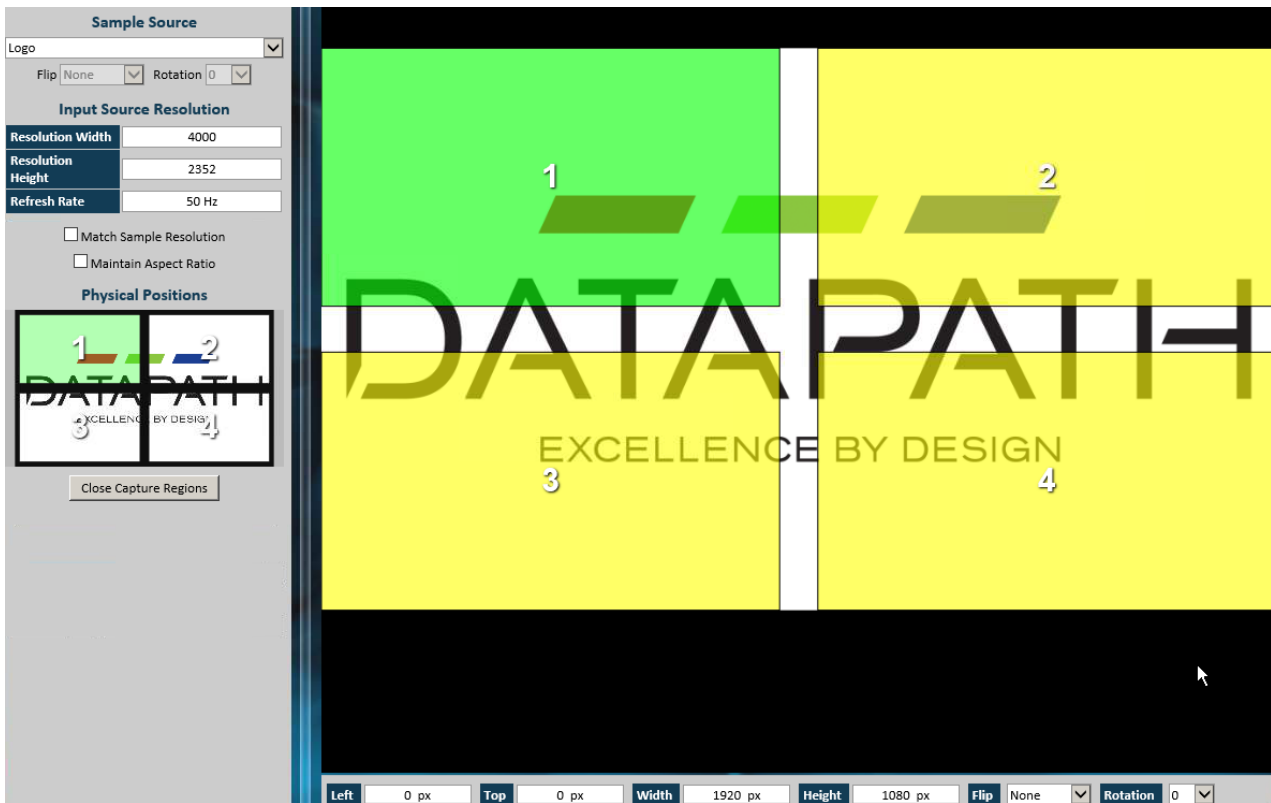

In our setup, two Datapath devices were connected to 4 screens each. The bezel internally between 2x2 screens is taken care of by the Datapath configuration, as shown above. But there is also a gap between the two blocks of 4 screens, which is outside the Datapath areas. This gap (170 pixels) was taken care of in the nVidia Mosaic configuration. The total resolution for the renderer then became 8170x2352.

## Setting up the Video Wall in Multiplay

In Multiplay, the goal is now to use the Datapath configuration as a backdrop for editing the GFX channel layouts (presets).

## Create the Video Wall

First of all, when creating a new video wall in a profile, we now know that the physical layout of the wall should be determined by the Datapath configuration, and not rows and columns in a nVidia Mosaic setup. We therefore specify that our wall consists of one, big surface (one row and one column) and specify the screen size to match the total resolution of the Viz Engine renderer. In our typical setup, 2 x 4K plus bezel between the screens ended up in a resolution of 8170x2352.

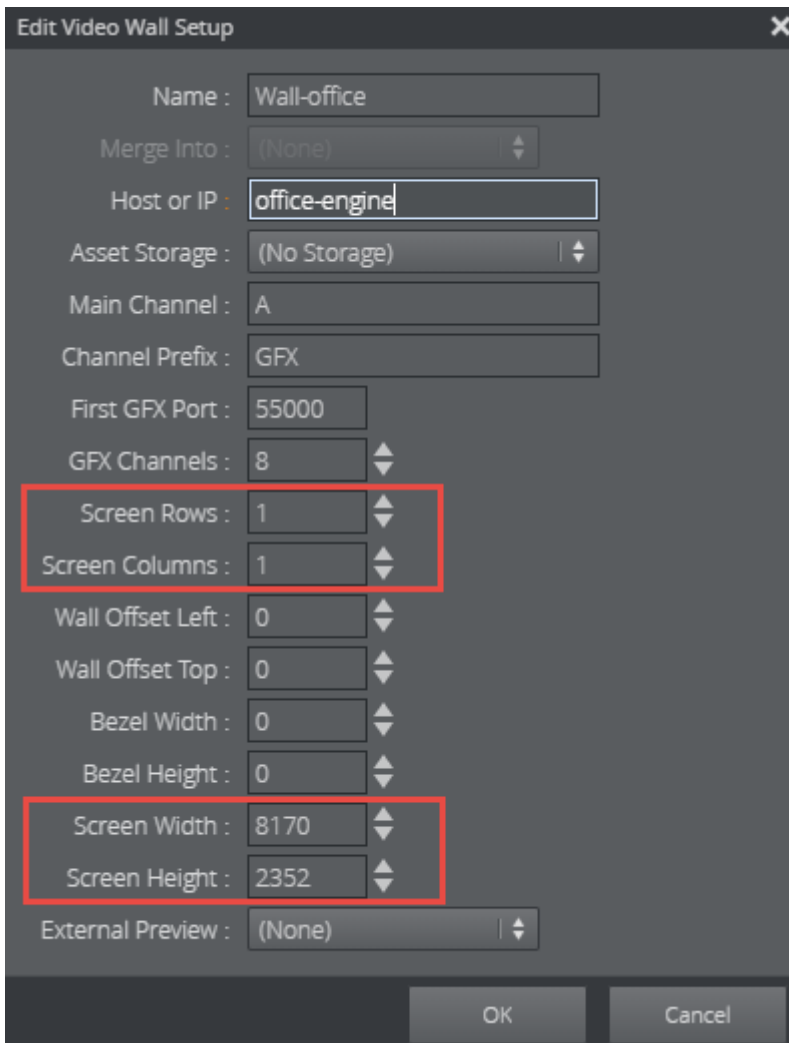

## Video Wall Designer

In the Video Wall designer, it is possible to create and edit the Active Areas, which will become snap points for the GFX layout (the presets). But since the visual configuration already is done in the Datapath Wall Designer, we can import this configuration into Multiplay. In Datapath Wall Designer, you need to save the configuration. This becomes a \*.wdl file, which consists of an XML structure describing the Datapath setup (inputs and capture areas). If you have more than one Datapath box connected to the computer running the Wall Designer, or on the network, the wdl file contains the combined configuration.

- In the Video Wall designer, click the Active Areas Editor button:

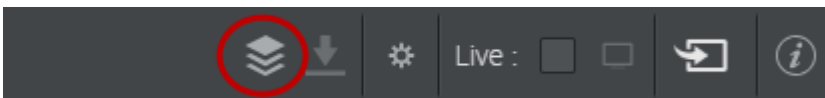

In the Active Areas editor mode, the GFX channels are hidden, and only the backdrop is visible. For now, the backdrop is one, empty area.

- Now you can import the wdl file by clicking the Import button:

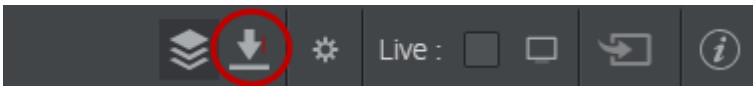

A dialog box then opens. Either click the area in the middle or drag the wdl file into this area. The PC you're running Multiplay on needs to have access to this file, either from a shared disk - or you can copy the file from the Datapath Wall Designer PC to the Multiplay PC first. When the file is read - a green status message will display the file name and a "Done!" message. Under this message, the number of Datapath wall regions (capture areas) is displayed.

- Click Add to generate the Active Areas in the Video Wall designer.

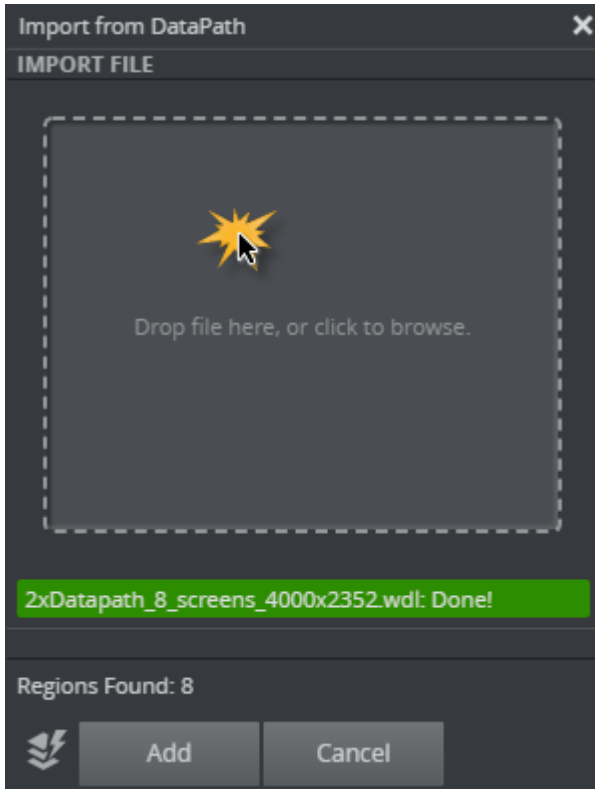

The next time this operation is done - it is possible to clear the existing Active Areas first, by clicking the following toggle button:



After importing and possibly editing the Active Areas from the Datapath configuration, the Video Wall designer may look like this:

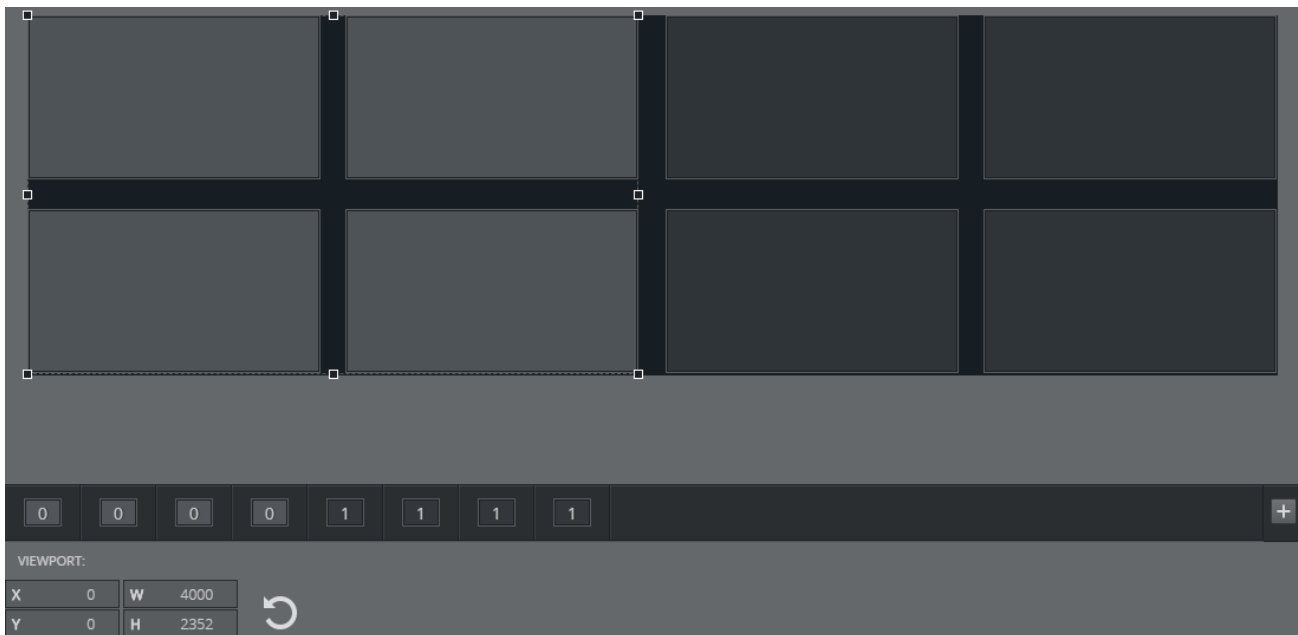

In this case, we have imported 8 regions from 2 Datapath boxes. Each of the Datapath devices is represented as a group of Active Areas. The numbers below the editor (0 and 1) indicate which group each area belongs to.

- Clicking once on an Active Area will select this area individually.
- Clicking the next time will select the group this area belongs to.

✓ **Tip:** When importing a Datapath configuration containing more than one Datapath device, the groups will initially be placed on top of each other in the editor. The Datapath configuration contains no info on where the outputs of the devices are located relative to each other. In our typical setup, both groups of 4 screens ended up on the left side of the video wall representation in the editor. The second group then had to be dragged to the right side of the video wall. In this case, it is useful to enable the "Live" function and the "Fill color" function to ensure that the Active Areas actually match the monitors in the video wall.

## 2.4.5 Working with Superchannels

This section covers the following topics:

- [Recommended Workflow](#)
- [Working with Superchannels in Viz Artist](#)
- [Organizing Presets with the Viz Artist Presets Plugin](#)
- [Working with Superchannels in Viz Multiplay](#)
  - [Creating a Profile and Add a Video Wall](#)
  - [Working with Superchannel Presets in the Video Wall Designer in Viz Multiplay](#)
  - [Using Video Wall Presets in a Show](#)



**Note:** Superchannels in Viz Multiplay requires **Viz Artist / Engine**. See the release notes for more on version requirements.

A *Superchannel* is an abstraction on top of specific media asset channels. Superchannels support different types of media assets: Images, Graphics, Clips, Streams, Live content etc. With Superchannels, content in each channel can be played out in an A/B workflow. Each Superchannel has two sub channels. One sub channel (A) is active, while the second (B) is inactive. New content can be prepared in inactive sub channels, and a transition effect can run the transition from the active to the inactive sub channel, switching their roles.

In a Superchannels-based video wall scene, you can customize transitions between preset positions in the video wall layout, and combine content and preset transitions to create more advanced visual video wall behavior.

**Note:** With Superchannels, each Video Wall design is represented by its own Viz Artist scene - whereas in the DynamicChannels solution, all video walls share one Viz Artist scene in the Graphic Hub.

## Recommended Workflow

1. Create a video wall with a default scene in Viz Multiplay, and use Viz Multiplay's [Video Wall Designer](#) to create the basic presets.
2. Switch to Viz Artist for complex manipulation, like adding custom transitions.
3. When switching back to Viz Multiplay, remember to re-import the presets to the show.

**Note:** You can also create a Superchannels-based video wall scene in Viz Artist and import it into Viz Multiplay. The scene must then contain the Viz Artist *Presets* plugin, which organizes the presets in the video wall layout

## Working with Superchannels in Viz Artist

In Viz Artist, find Superchannels in the Plugins tab, under Super:

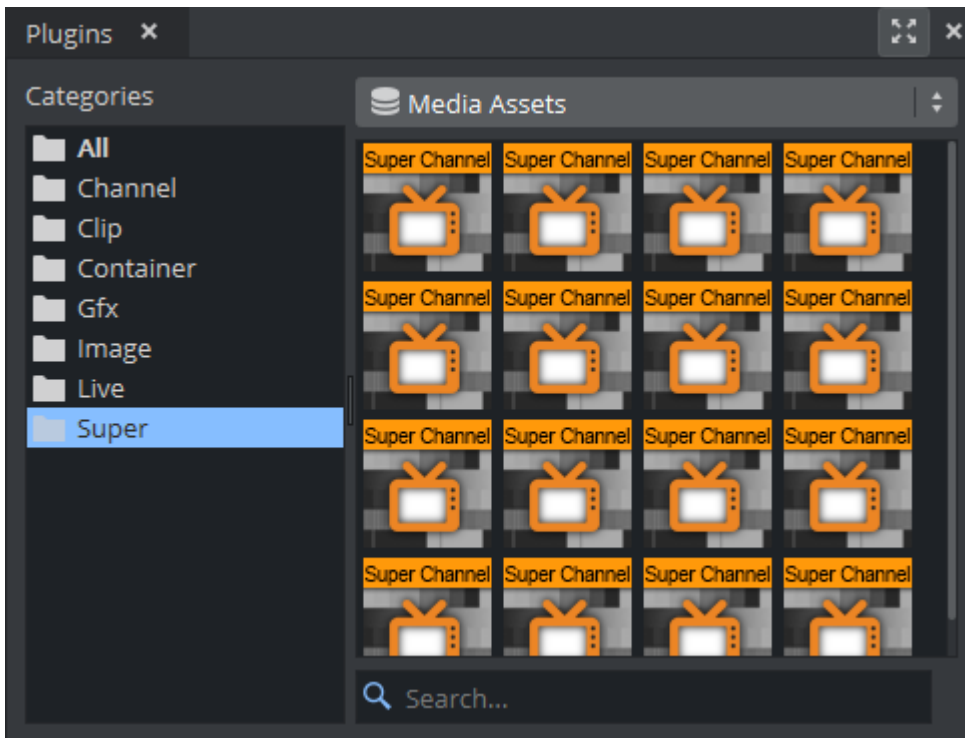

These channels should be added to the scene through the Presets plugin. The layout (size and position) of the Superchannels in the renderer can be organized manually in Viz Artist. A single set of pre-defined Superchannels layouts is called a *preset*. When played out, the scene will arrange the Superchannels in their previously saved (preset) position.

## Organizing Presets with the Viz Artist Presets Plugin

Use the plugin to add and organize more presets in the same scene. To create a video wall scene in Viz Artist:

- Create a new scene
- Find the Presets under **Plugins > Control > Scene Plugins** and drag it into the **Plugin** section of Scene Settings.
- Go to the Presets plugin GUI under **Scene Settings > Plugin**, and add, delete or manipulate presets and transitions between them. Each preset will get a name that is later visible to the Viz Multiplay operator - along with a visual representation of the preset.
- Also use the Presets plugin to **add superchannels** to the scene - as this will auto create content transitions between the sub channels.

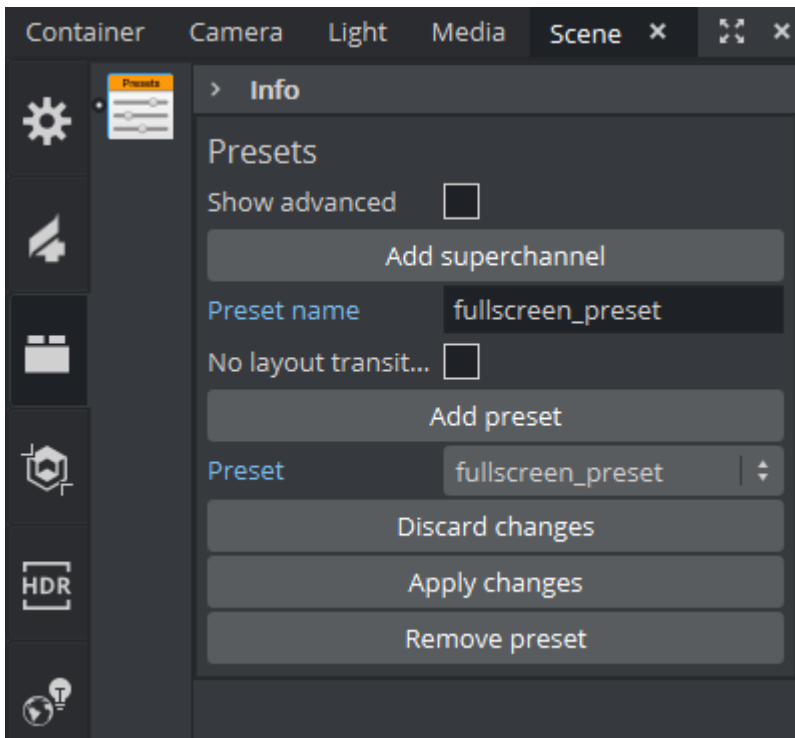

The plugin will automatically generate directors for

- The preset initial position (for a Cut to the preset)
- Transitions to and from all presets (one director per combination, running forwards or backwards)
- Content transitions (crossfade) between content in each Superchannel

In the following example, two presets called **all-visible** and **full\_screen1** have been added to the scene using the Presets plugin:

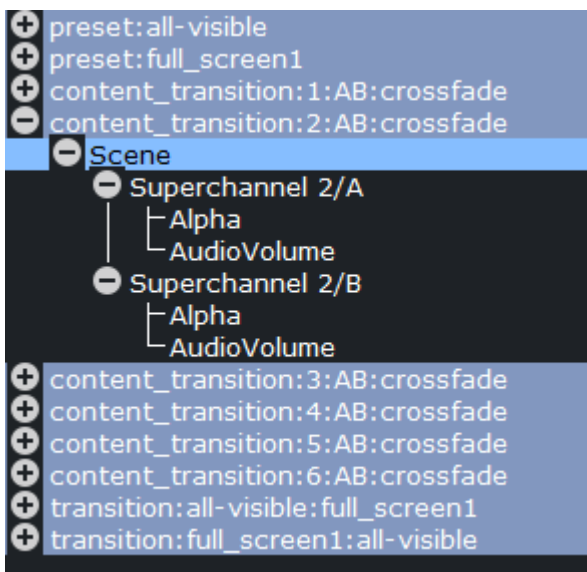

When you're done in Viz Artist, the scene can be saved and imported into Viz Multiplay as a new video wall design.

**Note:** In Viz Multiplay, when you do a Take on a preset, the Media Sequencer ensures the director leading from the current preset to the taken preset is run inside the scene. When new content is taken inside a Superchannel in the preset, the Media Sequencer ensures the content transition director is run for the Superchannel, switching from the existing content to the new content. This director is run regardless of the old and new media asset type, for example, from clip to image or graphics to live. All content types will get the same transition.

## Working with Superchannels in Viz Multiplay

Create and organize presets with Viz Multiplay. To create a new video wall, create a profile and add a video wall under the **VideoWalls** tab.

### Creating a Profile and Add a Video Wall

**Note:** The video wall engine must be started and in On Air mode when you create a video wall. Viz Multiplay will read out the Graphic Hub host and user name, along with the current resolution of the wall.

**Note:** This operation only needs to be done once per physical video wall.

- Go to **Settings > Profiles**
- Create a profile
- Click the **Plus** button to add a video wall under the Video Walls tab

**New Video Wall Setup**

Name : Big Studio Wall

Engine : localhost ✔

Asset Storage : (No Storage) | ▾

External Preview : (None) | ▾

Channels : 4 | ▴ ▾

---

Graphic Hub host : localhost ↻

Graphic Hub user : Guest

Resolution : 1920 x 1080

OK Cancel

- Specify the host name of the video wall **Engine**.
- Specify the number of **Channels** you need,
- Select an **External Preview** engine
- Select the publishing point used if you use a Viz One media asset provider; this ensures that clips are transferred from Viz One to the playout engine.

When you click **OK**, the following happens:

- The Media Sequencer creates viz and video handlers to communicate with the engine specified.
- A new design entry is added to the video wall with the same name as the video wall.
- A new scene is created under **Vizrt/VideoWall/** in the Graphic Hub.
- A default preset is created inside the new video wall scene.

You now have a Video Wall in your profile (**Big Studio Wall**), a new scene (**Vizrt/VideoWall/Big\_Studio\_Wall**) in Graphic Hub with a default preset.

You can rename the design to something more descriptive. Although the design is renamed **Morning Show** in the screenshot below, it still points to the same scene in Graphic Hub. You can find the scene name and scene path to the video wall scene by hovering your cursor over the design entry in the Super Walls tab:

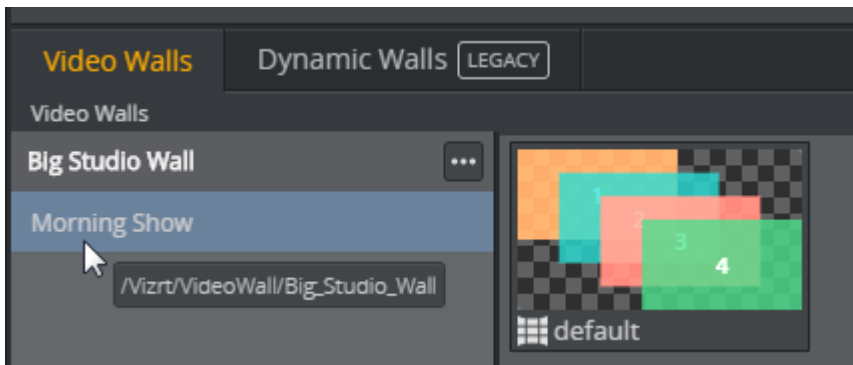

You can add more designs (scenes) to this video wall later - for instance one for a morning show and one for an evening show.

**Info:** To switch designs, play out the corresponding presets from Viz Multiplay. The engine will then play out the new design scene with the wall presets.

New position and size data is sent from Viz Multiplay to Superchannels as a percentage - if you change the resolution or aspect, the presets maintain their same relative dimensions. The best practice is to start the wall engine in the resolution in which it is to be operated in order to ensure that this is correct from the beginning.

**Note:** Resolution and aspect data can be refreshed later if the video wall engine needs to change resolution.

**Note:** Editing, adding or removing a preset requires the Video Wall engine to be on and in On Air mode. This is because the data for a preset now is stored inside a scene, which requires the Viz Engine to save the scene. If the wall engine cannot be disturbed, the best practice is to edit video wall presets on a preview engine *with resolution in the same aspect*, in a different profile.

## Working with Superchannel Presets in the Video Wall Designer in Viz Multiplay

Once a video wall and a scene with a default preset have been created, you can adjust preset positions and add more presets in the Video Wall designer:

- Go to **Settings > Profiles**
- Click the profile with the video wall engine
- Click the design entry under a video wall (**Morning Show** in the example below)
- The presets for the scene design are now visible
- Right click a preset and select **Edit preset**

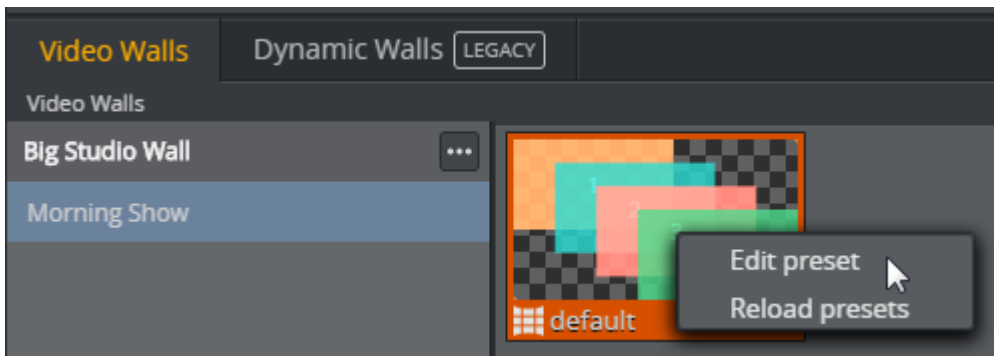

Now the Video Wall Designer opens. Here, you can add, delete, duplicate and edit presets with the [Video Wall Designer](#) tools.

When you click **Save**, the scene and all presets are saved in Graphic Hub through the Viz Engine. This means that the video wall Viz Engine must be started and On Air. When closing the Video Wall Designer, the updated presets for the design are displayed in the video wall manager:



## Using Video Wall Presets in a Show

Superchannel video wall presets are resources belonging to a specific Profile. The Profile contains the video wall description and keeps track of the designs (scenes) for the video wall.

When creating a Show with content, the presets for the Video Wall you want to use in the Show must be imported into the VideoWall tab:

- Click the **Video Walls** tab
- Click the **plus** button
- Click the video wall design to import the presets

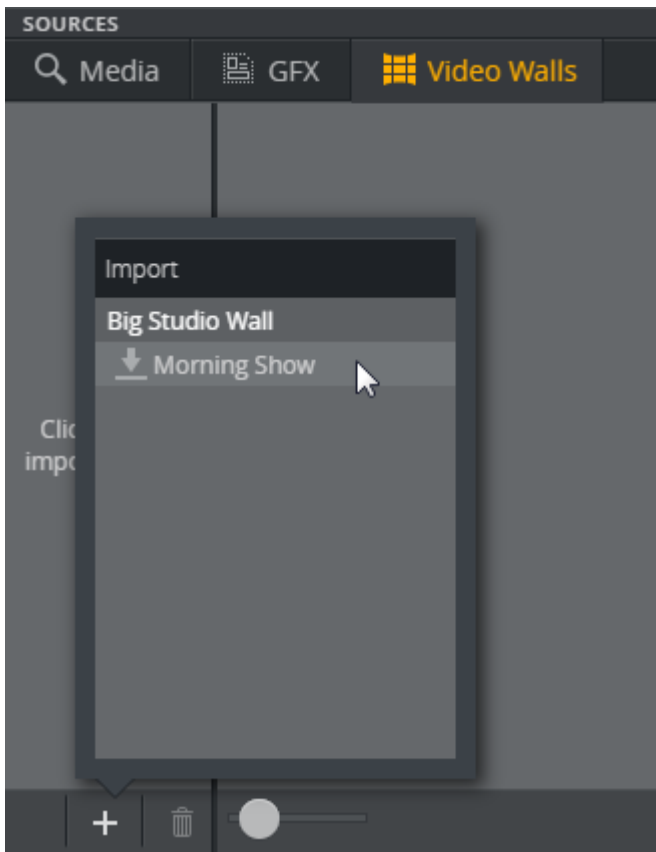

The presets for the video wall design you imported now appear in the Video Walls tab:

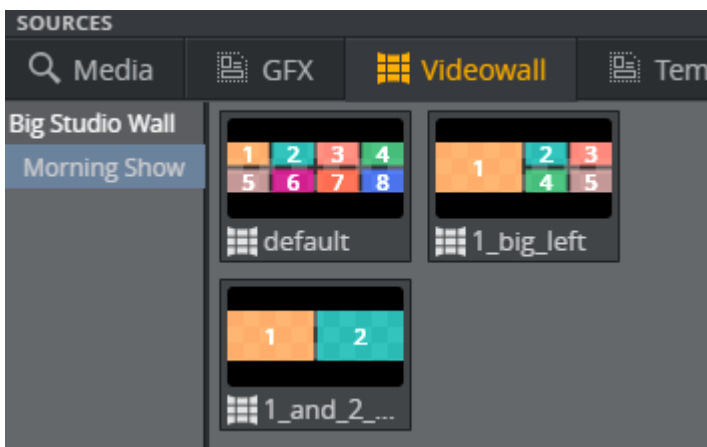

To use the presets, drag them over to the Shortcuts bar.

**Note:** The recommended workflow is to create one Shortcuts tab per video wall design in order to group the presets belonging to each wall.

**Note:** When controlling multiple video walls from the same Show, it's good practice to create one Workspace per video wall - only displaying the channels and Shortcuts groups relevant for the video wall to control.



## 2.4.6 Working with GFX Channels

Multiplay bundles two scenes: **DynamicChannels** and **StillAndVideo**. These scenes ensure that video wall presets are played out and that still images and clips are supported inside the channels. The underlying mechanism is GFX Channels in the Viz Engine. Each GFX channel has one layer where it can host a graphic scene from Viz Artist. The StillAndVideo scene is a placeholder for images and clips. The GFX channels have no transitions between content and no A/B workflow. Only one scene at a time can be hosted in a GFX channel.

**Note:** Superchannels, which contain transitions and an A/B workflow, are supported. Each Superchannel has two sub channels.

### Creating Presets

1. Start by creating a video wall setup in a profile, under **Dynamic Walls**.

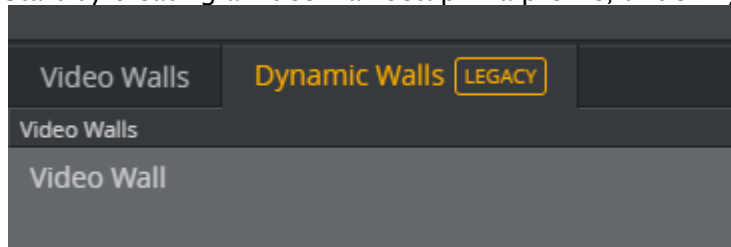

2. Create a show.
3. Activate the profile.
4. When you create a new show, Viz Multiplay automatically creates a separate playlist for presets that is displayed under the **Dynamic Walls** tab in the sources pane:

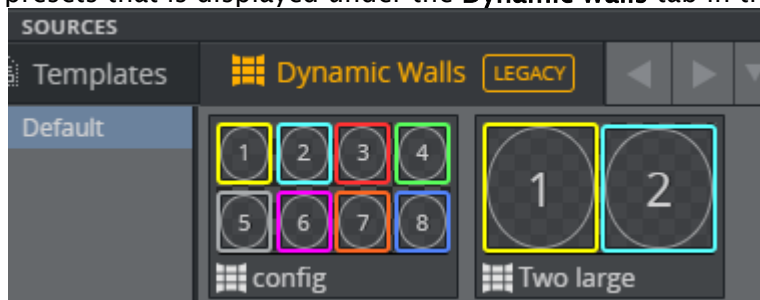

5. If you want to organize your presets in groups, you can create new groups in the Videowall playlist, or keep the existing **Default** group.



6. Create presets in a group by clicking **Add (+)**:



**⚠ Note:** Presets created in the video wall playlist should be thought of as templates. These presets cannot be played out directly, unless you are in the Video Wall Designer. The purpose of this step is to prepare a set of basic presets that can be used later when the content of the show is created. Presets are created with a 4 x 2 layout by default.

7. Right-click a group to connect it to a video wall in the active profile.
8. Select the Video Wall this group should represent.

## Edit Presets

1. Right click **Presets** in the Dynamic Walls tab and enter the Video Wall Designer.
2. You can reorganize the layout of the GFX channels in the designer.
3. **Save** the presets when you are finished.

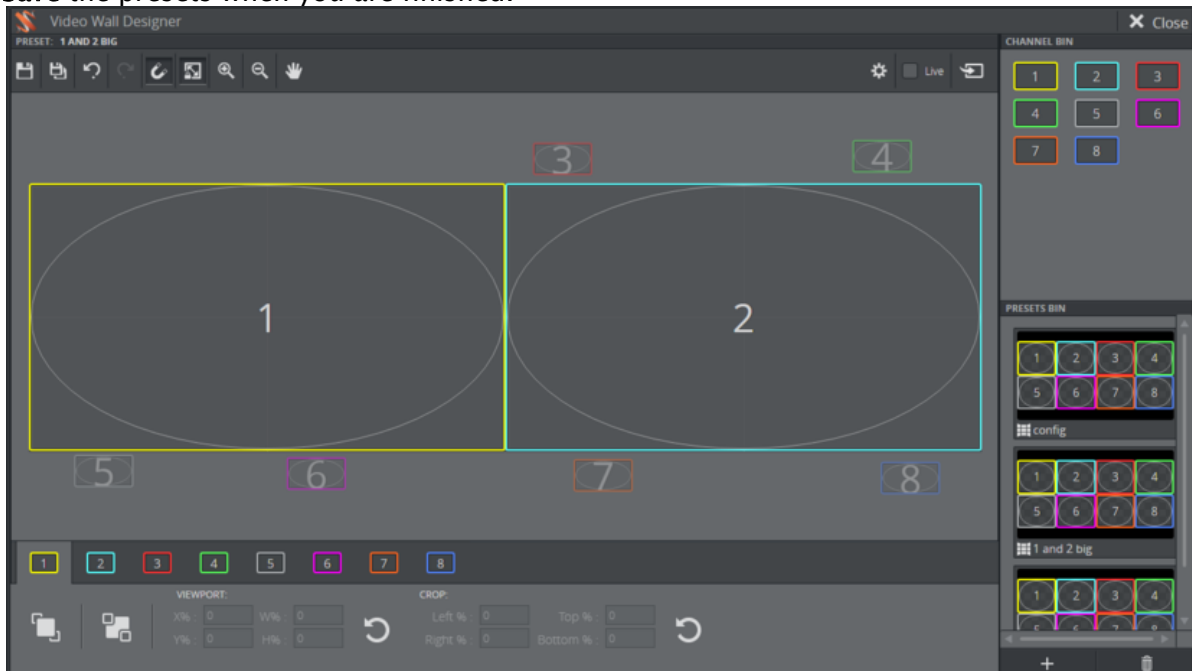

**✓ Tip:** Play out the content in the renderer in all the GFX channels before adjusting the GFX channels in the Video Wall Designer. This allows you to click **Take** or check the Live box from within the Video Wall Designer. The positions and dimensions of the content adjust automatically when you are working in the Video Wall Designer.

- ✓ **Tip:** If you want GFX channels to not be visible in a preset - do not disable them. In terms of performance, it is better to drag the presets outside the video wall area and/or resize them to a smaller size.

## Fine-tuning GFX Channels

After working with presets in the Video Wall Designer, you will have some preset templates with different layouts.

To fine-tune the size or positions of the GFX channels, do the following:

1. Enter the Video Wall Designer and click **Take**.
2. Return to the main GUI in Viz Multiplay.
3. Play some content out in each GFX channel and enter the Video Wall Designer again.
4. Now check the **Live** box and fine-tune the GFX channels.
5. The output on the physical screens will update live as you adjust the GFX channels in the Video Wall Designer.

## Presets Tab

When a set of presets is created in the DynamicWalls source area, drag the presets you want to use in the show into the Presets tab in the Shortcuts area. Create more tabs in this area and organize your presets here.

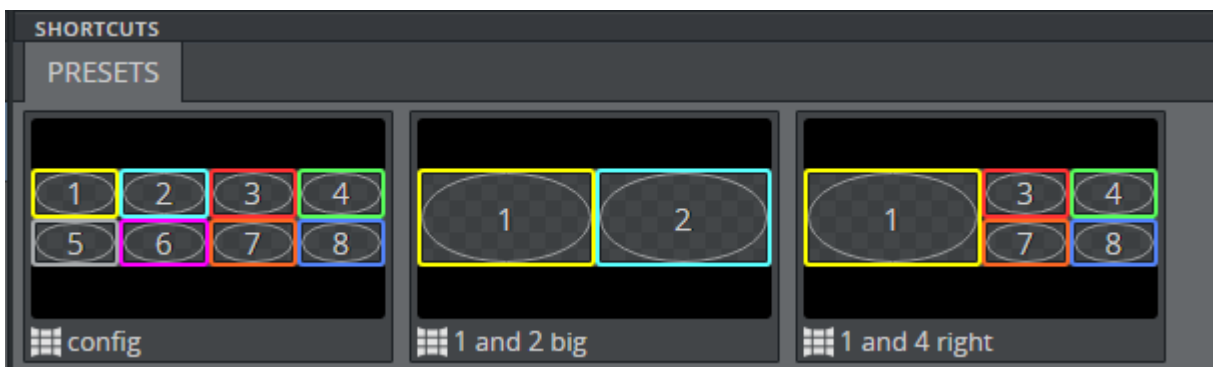

### See Also

- [Using Shortcuts](#)

## 2.5 Configuring Workspaces

Workspaces can be used to adapt the GUI to one specific role, such as the anchor in the studio or the person responsible for playing out a part of the video wall or control one of several different video walls. In each workspace, you can:

- **Hide channels** that should not be visible for the Viz Multiplay operator.
- Specify a **custom set of shortcut tabs** - shared or private to the workspace.
- Specify a **keyboard shortcut** to activate this workspace.

- **Privately Arm elements** without affecting armed elements in other workspaces.

This section will explain more about:

- [Hiding Channels](#)
- [Shortcuts per Workspace](#)

## 2.5.1 Hiding Channels

A workspace can specify channels that should not be visible. For instance, the main channel should often be hidden from the user in a video wall setup. The main channel of a video wall is used to play out the presets, which are usually located in the Shortcuts bar. It is therefore not necessary to populate or show the main channel (normally called **A**) in the GUI.

To hide the **A** channel:

1. Go to **Settings > Workspaces**.
2. Create a new workspace by clicking the **Add (+)** button in the Workspaces list.
3. Add the names of the channels you wish to hide by clicking the **Add (+)** button in the Hidden Channels list.

✓ **Tip:** Hide multiple channels by right-clicking the Hidden Channels panel and selecting the relevant channels from the context menu.

4. Enter the name of the channel to hide.

⚠ **Note:** This hides the channel regardless of which profile is active. If you hide channel **A** in the workspace, the channel called **A** is hidden for all profiles you activate.

5. Activate the workspace by clicking the **Activate** button.

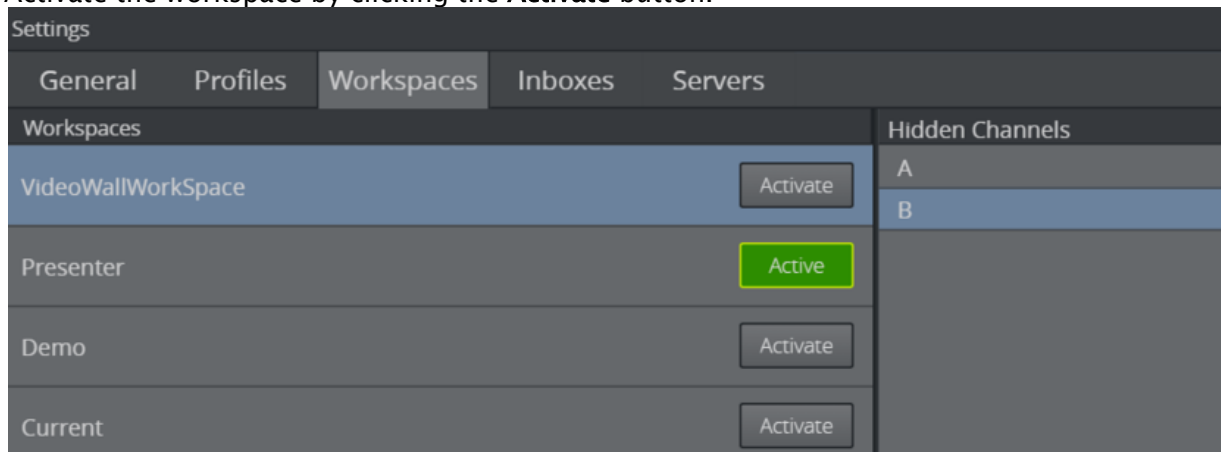

## 2.5.2 Shortcuts per Workspace

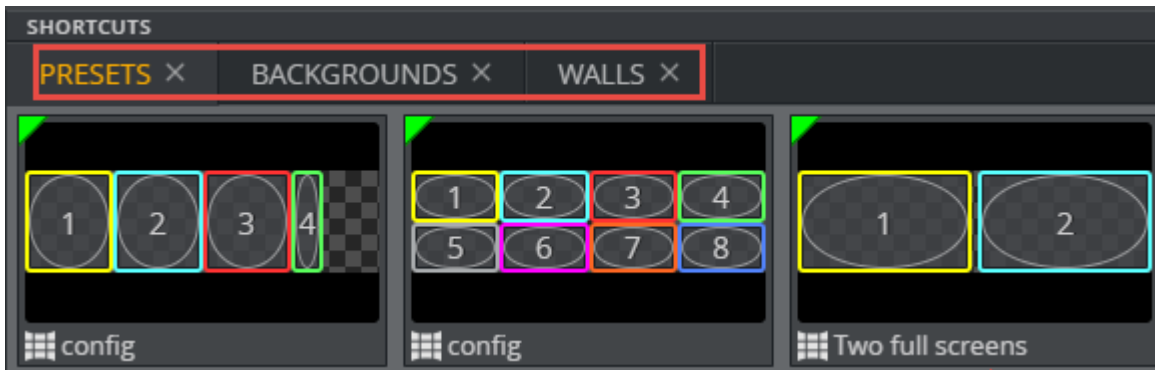

Shortcut tabs in a show can be shared between all workspaces or they can be assigned to specific workspaces.

- Go to **Settings > Workspaces**.
- Click a workspace.
- Check **Only show selected shortcuts**.
- Check one or more shortcuts group listed.

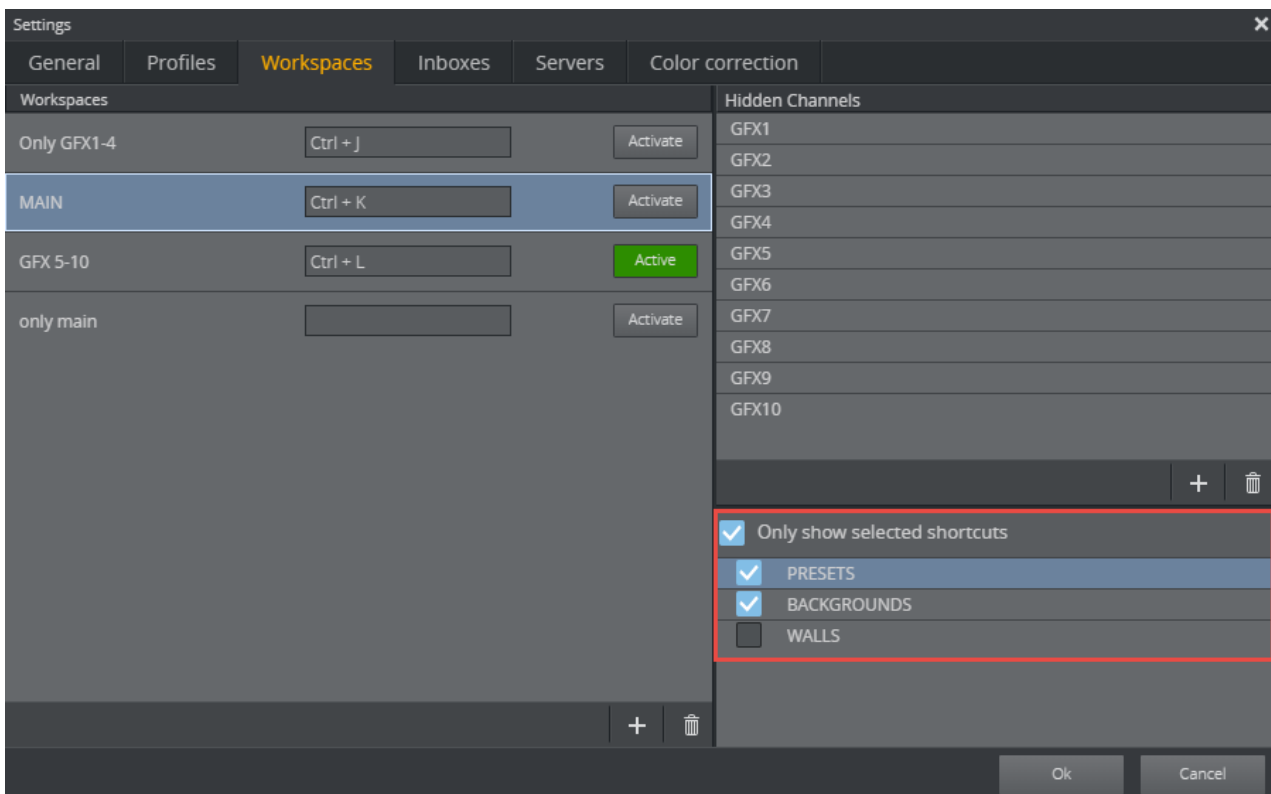

If **Only show selected shortcuts** is checked, and no workspace is active - all shortcut tabs are visible.

If **Only show selected shortcuts** is checked, and a workspace is active - only the checked shortcut tabs in the list will be active. One shortcut tab can be visible in multiple workspaces. When

creating new shortcut tabs when **Only show selected shortcuts** is checked, the new tab will automatically belong to the active workspace.

## 2.6 Configuring The User Interface

This section covers the following topics:

- [Layout Options](#)
- [Toolbar](#)
- [Hide Sources Pane and Show pane](#)
- [New and Open](#)
- [Settings](#)
- [1-Tap Mode](#)
- [Cleanup and Initialize](#)
- [On Air Mode](#)
- [Tablet Set-up](#)
- [Resizing and Collapsing Channels](#)

### 2.6.1 Layout Options

- For a list of supported browsers, see [Configuring Clients](#).
- Channels are collapsible individually and their size can be adjusted, see [Resizing and collapsing channels](#).
- Viz Multiplay can be run in portrait mode, which allows more space for displaying channels.

### 2.6.2 Toolbar

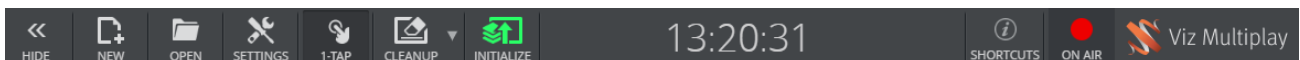

Configure how Viz Multiplay looks in your display from the tool bar using [Settings](#), [Hide Sources Pane and Show pane](#), and [1-Tap Mode](#).

Click on the Viz Multiplay logo for version information, as well as links to documentation and third party licenses.

### 2.6.3 Hide Sources Pane and Show pane



Click the **Show/Hide** button in the toolbar to toggle both the [Show Pane](#) and [The Sources Pane](#) on/off.

## 2.6.4 New and Open



Create a new Show or open an existing one.

## 2.6.5 Settings

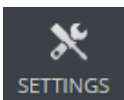

Open the Viz Multiplay Settings window from the tool bar.

- From the **General Tab**, you can change the thumbnail size, show/hide the status bar, and set whether to display a preview in the [Program](#) column when clips are taken to air.
- Use the **Profiles Tab** to individually configure Profiles, Channels, Viz Engine handlers and Viz Video handlers, as well as easily configure video walls.
- Use the **Workspaces Tab** to create Workspaces, which define which sets of channels are hidden from view for each type of user.
- The **Inboxes Tab** allows setup of one or more global shows in which multiple users can ingest new elements (images, clips, graphics) simultaneously. These elements are available to the Viz Multiplay operator instantly.
- Use the **Servers Tab** to configure preview servers and MAM systems that help to search media quickly.

## 2.6.6 1-Tap Mode

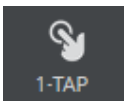

When 1-Tap mode is enabled, the [Armed](#) column is hidden and tapping an element or shortcut in the Media column will take it directly to [Program](#). In this mode, elements can still be dragged between channels, or dragged to the program channel.

When 1-Tap is disabled, tap arms an element. Tap in the Arm column to take it to Program. Drag elements to the preview pane to preview them.

## 2.6.7 Cleanup and Initialize



Cleanup unloads resources from the Viz Engines in the current profile, while Initialize loads the scene resources of the Show onto the Viz Engines in the profile. See [Preparing and Playing Out Content](#).



Display the keyboard shortcuts in Viz Multiplay. See [Keyboard Shortcuts](#).

## 2.6.8 On Air Mode

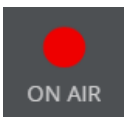

Click this button to toggle between on and off air mode. In On Air Mode, the button turns red and is labelled **ON AIR**. In Off Air Mode, the button is grey and labeled **OFF AIR**. Some functions in the user interface that are used for sending items to air in On Air Mode are not available in Off Air Mode. This is in order to hinder elements from accidentally being sent to air while editing a show or channel.

The following panels and columns are hidden in Off Air Mode:

- The [Arm and Take Multiple Elements](#) Action Bar.
- The [Armed](#) column.
- The [Program](#) column.

## 2.6.9 Tablet Set-up

As space is limited on a tablet, a compact layout is provided automatically. You can also consider using the following display settings:

- Hide the Status bar (See [Settings](#))
- [Hide Sources Pane and Show pane](#)
- Enable [1-Tap Mode](#)
- Adjust the Icon size (See [Settings](#))

## 2.6.10 Resizing and Collapsing Channels

Channels can be custom-sized, expanded by row or collapsed entirely.

- [Set custom channel size](#)
- [Resizing channels from the context menu](#)
- [Collapsing channels](#)

### Set Custom Channel Size

1. Hold down **ALT**.



2. Hover the cursor over the top edge of a channel header until the cursor turns into a row separator (row resize cursor).

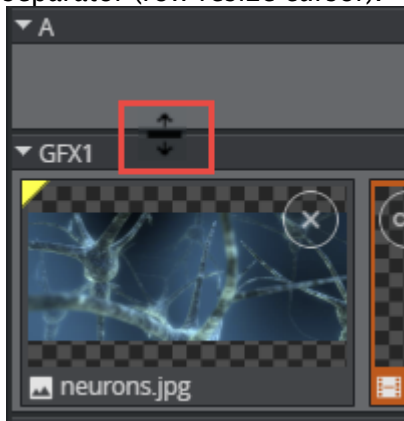

3. Drag the separator up or down as desired.

## Resizing Channels from the Context Menu

### Expand Channels by Multiple Rows

1. Right-click the channel header and select the **Set Height** menu item:

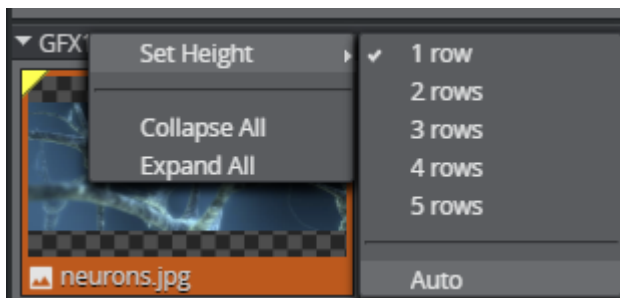

2. Select the desired row height.

### Auto Resize

Select **Auto** to enable automatic creation of new channel rows when new items are added to a full row.

## Collapsing Channels

### Collapse a Single Channel from View

- Click the channel header to collapse individual channels.

## Collapse or Expand Multiple Channels from View

1. Right-click a channel header.
2. Click **Collapse All** (or **Expand All** depending on the objective).

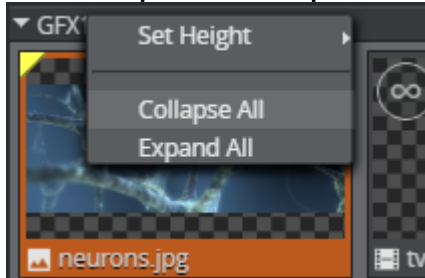

3. All channels in the Media Tab collapse:



✓ **Tip:** Use the keyboard shortcuts **SHIFT + C** and **SHIFT + E** to collapse and expand all channels, respectively.

✓ **Tip:** If a profile contains several video walls, the interface can quickly become crowded with channels. Create different workspaces to hide channels. The workspace is a personal setting that is specific to each Viz Multiplay client.

## 2.7 Settings

This section covers the following topics:

- [General](#)
- [Profiles](#)
- [Workspaces](#)
- [Inboxes](#)
- [Servers](#)

- [Color Correction](#)

## 2.7.1 General

Open the Settings window from the toolbar

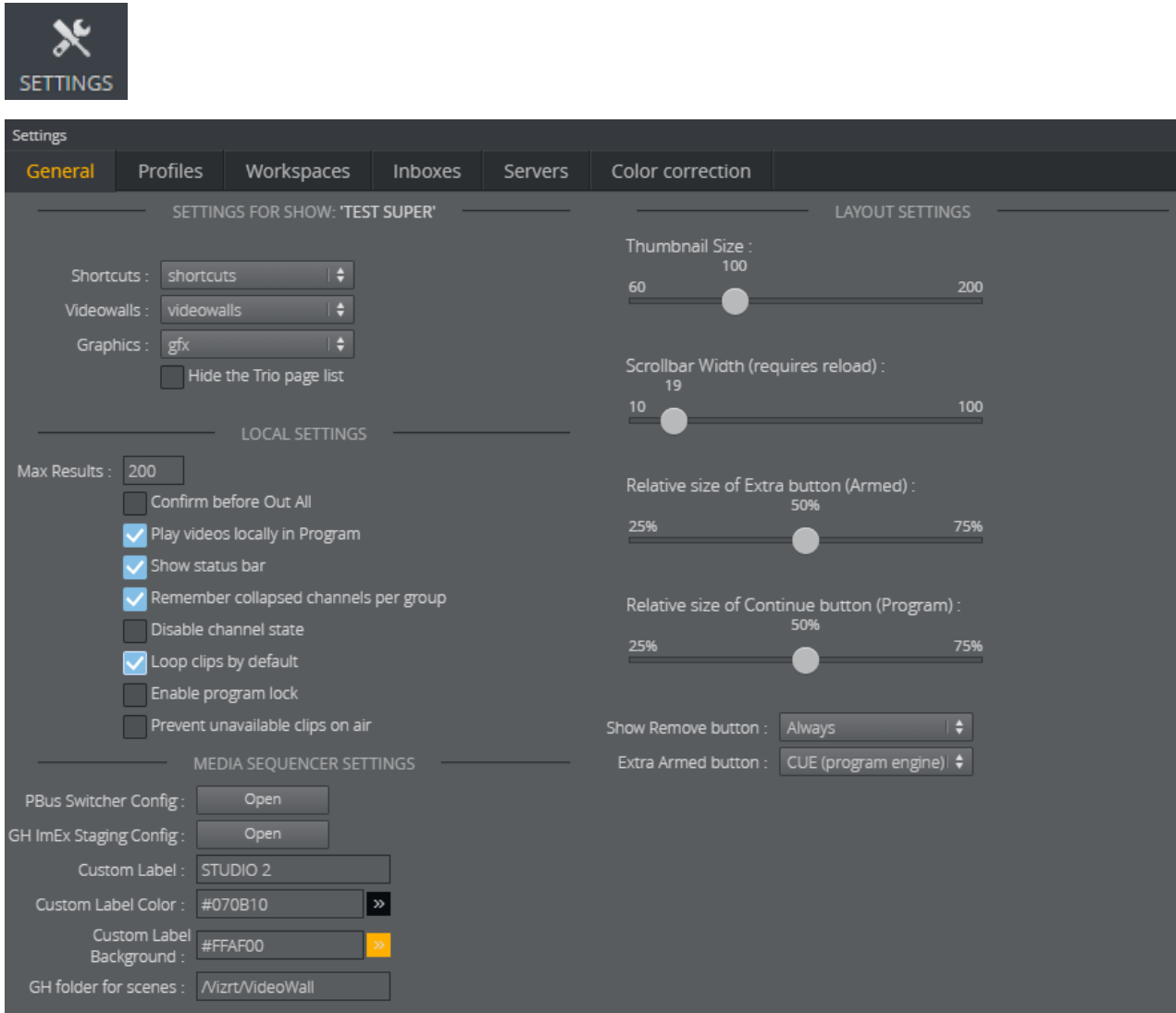

### · SHOW SETTINGS

- **Shortcuts:** Select the playlist that contains your preset layouts and background scenes. The shortcuts are then displayed in the Shortcuts Bar at the top of the main window.
- **Videowall:** Select the playlist that contains your Dynamic Channels videowall presets. This playlist will appear in the **Dynamic Walls** tab in the Sources area.

**⚠ Note:** The Videowall setting is discontinued for Superchannels. Superchannels presets are imported from the profile, and appear automatically in the **VideoWall** tab in the Sources area.

- **Graphics:** Select the playlist that contains imported graphics. This playlist will appear in the **GFX** tab in the Sources area.
- **Hide the Trio page list:** This can be useful if the Pilot workflow is used. The Trio page list is a special playlist that lets the Trio operator use numeric callup codes to play out graphics. In Viz Multiplay, the page list behaves like a regular playlist.

• **LOCAL SETTINGS**

- **Max Results:** Enter the maximum number of elements to be listed in the Scene importer, the Media tab and Pilot data elements in the Templates tab in Sources.

**⚠ Note:** The current search refreshes when a setting is changed.

- **Confirm before Out All:** When you click **Out All** a confirmation message appears:

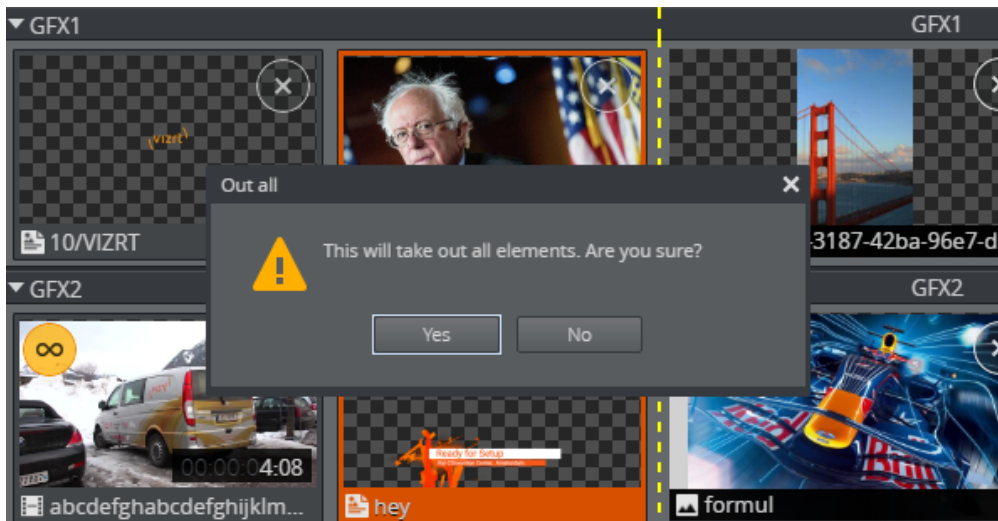

- **Play videos locally in Program:** show a preview in the **Program** column when clips are taken to air; a thumbnail is displayed when enabled.

**⚠ Note:** See [Armed](#) and [Program](#) for more information about cueing content.

- **Show Status Bar:** at the bottom of the screen.
- **Remember collapsed channels per group:** the collapsed/expanded state for each channel is stored per group. This is useful if one group contains content for a subset of the channels, while another group mainly contains content for another subset.
- **Disable channel state:** shows the last element taken in the **Program** column. This element is restricted to Multiplay. The **Out** and **Continue** buttons will only operate on this element. Other clients will not update the Program column. When unchecked, Channel State is used for Media Sequencer version 5.0 or higher. When Channel State is used, the **Program** column contains a more accurate snapshot of the content of the renderer and the **Out** and **Continue** buttons operate on all layers currently in the renderer.
- **Loop clips per default:** applies clips dragged in from a Media search.

- **Enable program lock:** prohibits playout for a channel, including playout by other Viz Multiplay clients who have the lock enabled locally.
- **Prevent unavailable clips on air:** clips that are flagged as unavailable to the playout engine are not available, preventing a clip that has not been transferred to the playout engine from being played out. Disabling this setting makes all clips available to the operator.
- **Custom Label:** Enter a free text and specify the background and foreground color to be displayed as a label in the toolbar area. This indicates at a glance which video wall or studio the interface is controlling:

This will be displayed in the interface:

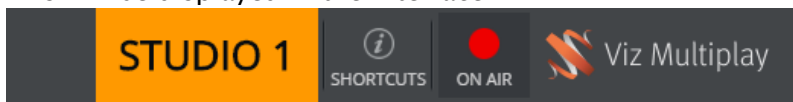

- **GH folder for scenes:** The default Graphic Hub path for the scenes in the DynamicChannels archive and for the Superchannels scenes.
- **LAYOUT SETTINGS**
  - **Thumbnail size:** of media icons in the Media column.
  - **Scrollbar Width:** (in pixels) of the vertical scrollbar in the Media pane. This can be handy when operating on a touch device. Default is 19.
  - **Relative Size of Extra button (Armed):** applies the Armed column (see below).
  - **Relative Size of Continue button (Program):** useful in preventing the operator from accidentally clicking **Out** instead of **Continue** in stressful situations. Make **Continue** bigger so it stands out.
  - **Show Remove button:** (the X) on playlists and elements. Use this to prevent accidental removal of elements and playlists:
    - **Always**
    - **Only when Off Air**
    - **Never**
  - **Extra Armed button:**
    - **None**
    - **CONTINUE:** Performs a continue operation on the external preview engine for a video wall, if preview is configured.
    - **CUE:** Sets the armed element at its first frame in the Program column.
    - **TRANS:** Swaps the content of the Armed and Program columns.
- **MEDIA SEQUENCER SETTINGS**

- **PBus Switcher Config:** Available if Media Sequencer supports the [PBus protocol for communicating with switchers](#) (requires Media Sequencer version 5.0 or higher). A new browser tab opens with the configuration application for communicating with the switcher.
- **GH ImEx Staging Config:** Available if Media Sequencer supports image staging to Graphic Hub (requires Media Sequencer version 5.0 or higher). A new browser tab opens with the [configuration application for the ImEx service](#), and all images in the active playlist originating from HTTP resources are automatically transferred to the Graphic Hub. The transfer status is shown on top of the images in the Media column. The status disappears once the image has been transferred to the Graphic Hub. This reduces the delay when the image is played out on air. Although the image still has to be transferred from the Graphic Hub to the Viz Engine on a Take, this operation is usually quicker than loading it from an arbitrary HTTP resource.

✔ **Tip:** To reduce delay even more, initialize the show containing the image; the Viz Engine will then load the image from Graphic Hub into the memory.

## Handler Status

The status of the handlers is shown by their icons. The status is refreshed when the Media Sequencer needs to refresh them or when the user opens a handler editor. Hover over a handler to display the error message.

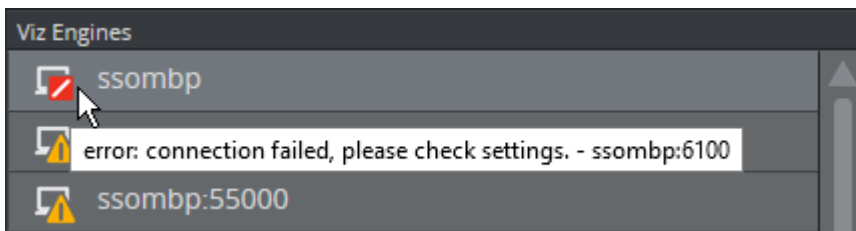

## 2.7.2 Profiles

Profiles are used to create different playout channel setups. Each playout channel represents one or more Viz Engines.

Open the Settings window from the toolbar

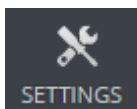

Use the **Profiles** tab under **Settings** to individually configure Profiles, Channels, Viz Engine handlers and Viz Video handlers, and to configure video walls.

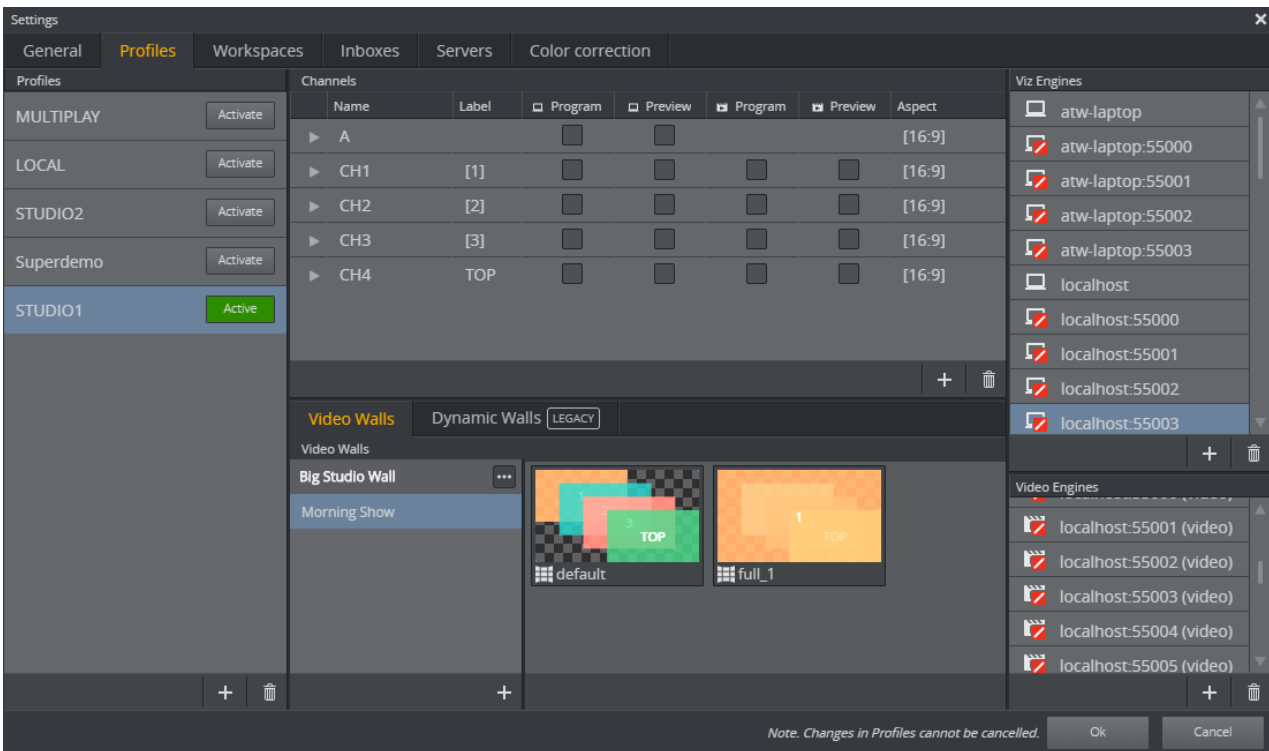

**Note:** The Profiles tab is similar to profile configuration in Viz Trio and Viz Pilot. It uses the same data as Viz Trio, so changes made via either application are reflected in both.

**Note:** Profile changes cannot be canceled.

Activate/deactivate profiles using buttons in the Profiles list:

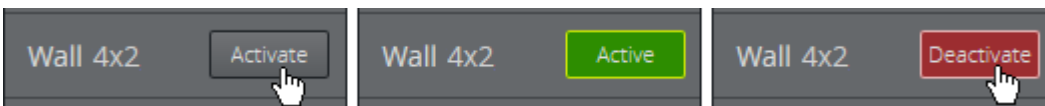

**Note:** Always set the Active Profile for a show in Viz Multiplay. If a show is activated by a Viz Trio client, then it will be deactivated if that Viz Trio client shuts down, and Viz Multiplay will lose its active profile.

**Note:** Renaming an active profile (from Viz Trio or Viz Multiplay) automatically deactivates the profile. Go back to **Settings > Profiles Tab** and click the **Activate** button for the profile again.

## Configuring Channels

Content can be played out on multiple channels, with as many outputs as desired. Typically, each channel has multiple outputs and each output is a single Viz Engine. In a typical video wall setup,

Viz Multiplay creates one main channel with one Viz Engine output to the default Viz Engine port (6100) and a number of channels with one Viz Engine output for graphics starting on port 55000, and one Viz Engine output for video.

**Note:** When elements are added to the channels in the [Media Pane](#), the channel name is reflected in the Viz Trio page list. However, in Viz Trio, you can also specifically assign elements to channels. If an element is assigned to a channel name that is not present in the active profile, then that element will not be visible in Viz Multiplay. The element will also not be visible if the element's channel is hidden in the active workspace.

Elements that are assigned to the [PROGRAM] channel will be displayed in the channel set to viz/video program in the active profile in Viz Multiplay, regardless of the channel's name.

**Note:** "Main channel" refers to the main channel of a video wall, while [PROGRAM] refers to the program channel of the profile.

**Note:** You can drag more outputs into the channels to make content play out simultaneously on multiple screens.

**Note:** Adding videos to a graphics-only channel or graphics to a video-only channel will result in the element not being played out correctly. Composite elements will only work on channels that support both graphics and video.

## Adding Custom Labels to Video Wall Channels

When adding a video wall to a profile, the different areas of the video wall are represented as channels. These are prefixed CH or GFX, for instance CH1, CH2, CH3 etc. In the different parts of the GUI, these channels are equivalent to their numbers, for instance in a video wall preset - the channel CH1 is just shown as the number 1 in the thumbnail where it appears. Though, it is possible to assign custom labels to the different video wall channels. When filling in content into the presets, it may be easier for the operator to identify the channels by names instead of number:



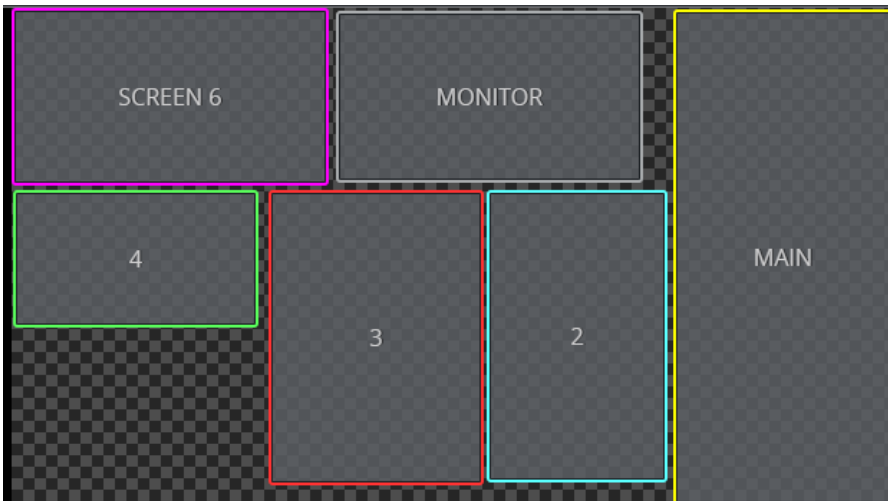

To assign labels to different video wall channels, go to **Settings > Profiles**, click a profile and modify the labels in the Channels column:

Channels	
Name	Label
▶ A	
▶ CH1	MAIN
▶ CH2	[2]
▶ CH3	[3]
▶ CH4	[4]
▶ CH5	MONITOR
▶ CH6	SCREEN 6

### 2.7.3 Workspaces

Workspaces define channels that are hidden from view for each type of user. Configuring multiple workspaces allows different users to have access to different channels. For example, an operator in the control room can access all channels, whereas the presenter in a studio can only see the channels they need to control.

**Settings > Workspaces**

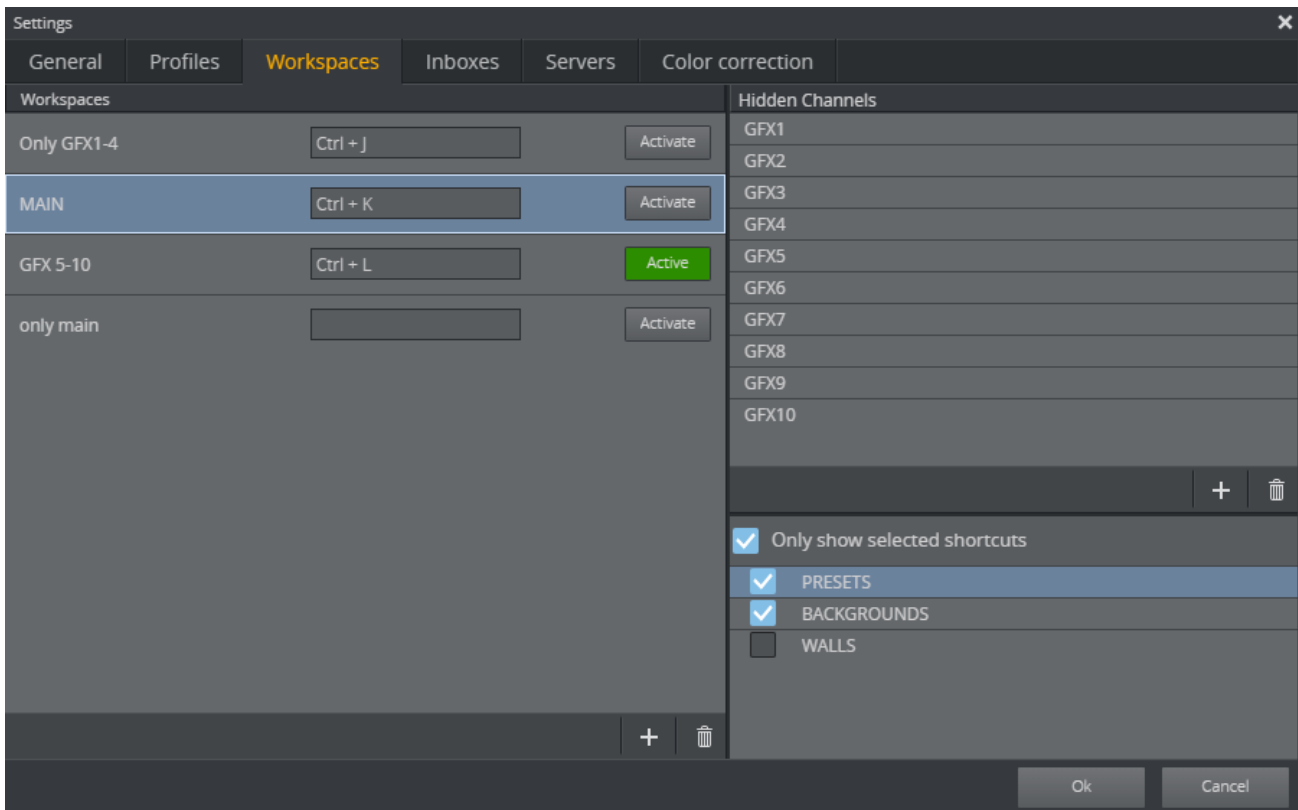

## Create a New Workspace

1. In the **Workspaces** pane on the left, click **Add (+)**, and give your new workspace a name.
2. In the **Hidden Channels** pane on the right, click **Add (+)** and type the name of the channel that you want to be hidden in this workspace.

✓ **Tip:** Hide multiple channels with a single click. See [Hide channel context menu](#) below.

3. Set the active workspace for this user by clicking the **Activate** button.

## Sharing Armed and Program Status with Workspaces

The status of the **Armed** column is shared according to the workspace - users with the same workspace will see the same armed content.

In contrast, the **Program** column is a global resource, which always shows what is currently on air in each channel. All Multiplay clients have a synchronized view of what is playing on air, independent of which user triggers playback.

## Hiding the Channel Context Menu

The Hidden Channels panel contains a context menu that allows you to hide multiple channels. Hide channels based on their type (GFX or Main channels) or on the video walls they are associated with.

✓ **Tip:** Right-click the Hidden Channels panel to open the hide channel context menu.

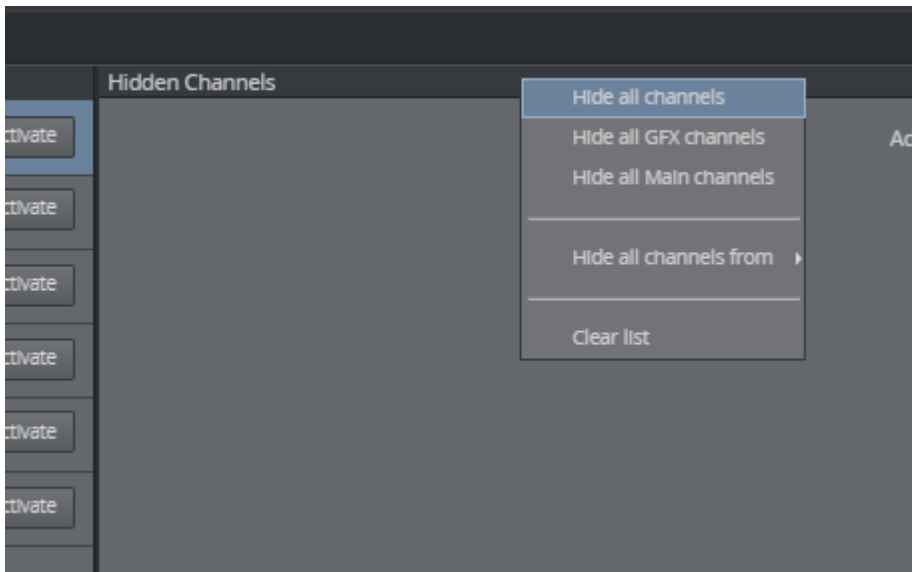

## Setting Keyboard Shortcuts for Workspaces

Switch workspaces with a custom keyboard shortcut. This allows you to switch workspaces without opening the Settings panel.

First, assign a keyboard shortcut using the following procedure:

1. Open the **Settings** window.
2. Click the **Workspaces** tab.
3. Enter a shortcut in the field in the middle:

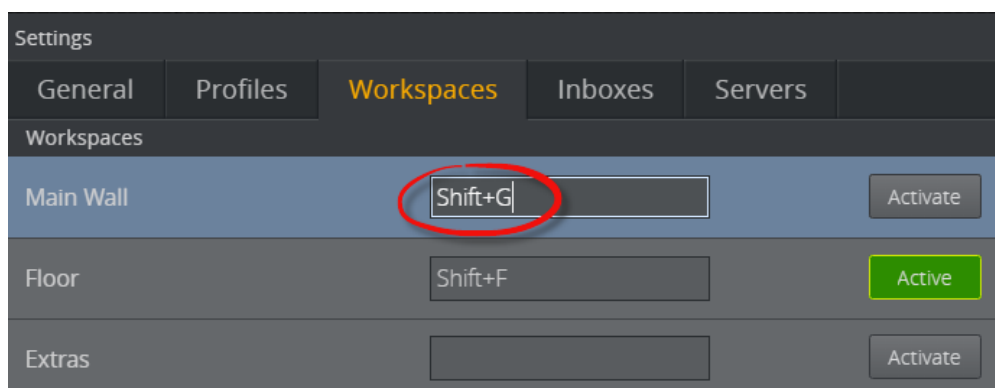

4. Click away from the field to confirm your choice.

✓ **Tip:** Do not press **ENTER** to confirm your shortcut choice. Pressing **ENTER** will assign **ENTER** as a shortcut.

5. Click **OK**.

## To Use the Shortcut:

Type the keyboard shortcuts at any time while viewing the main interface to switch between workspaces.

### 2.7.4 Inboxes

Inboxes are sources of content that are always available as an **Inbox Tab** in the [The Sources Pane](#). You can configure multiple inboxes.

Any show on the Media Sequencer can be used as an inbox.

**Note:** The inboxes you configure are global, so they will be available in all shows.

#### Settings > Inboxes

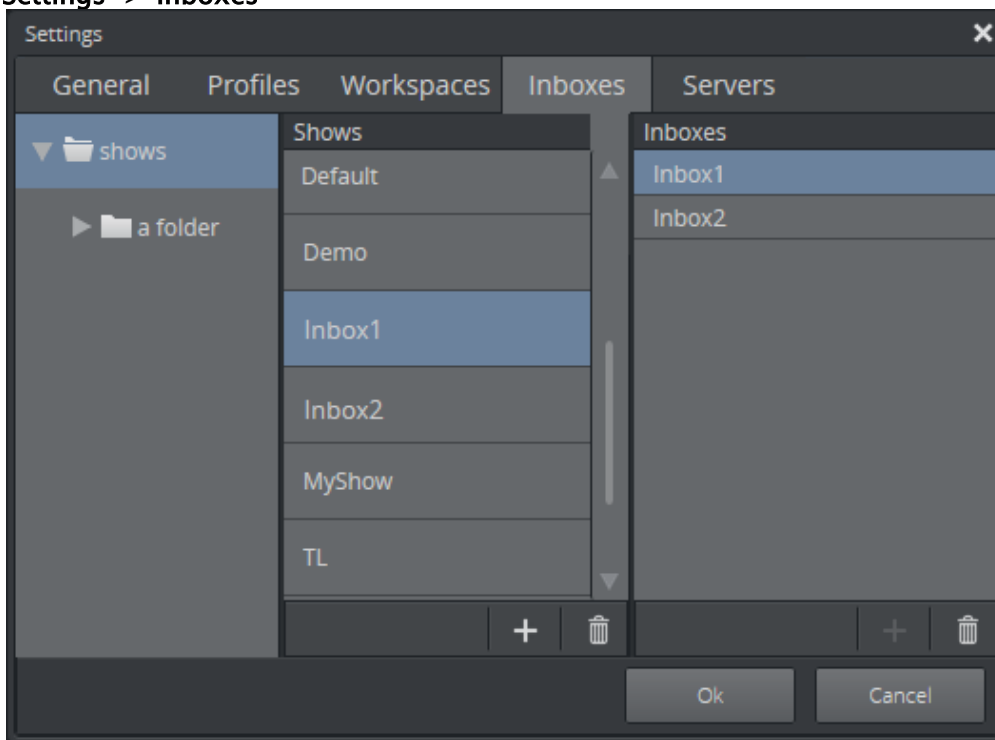

#### Configure a Show as an Inbox

- Drag the show from the **Shows** list to the **Inboxes** list, it will then appear as an **Inbox Tab** in the [The Sources Pane](#), as shown below. Any content added to this show will be available as an **Inbox** tab, and can be dragged to a channel.

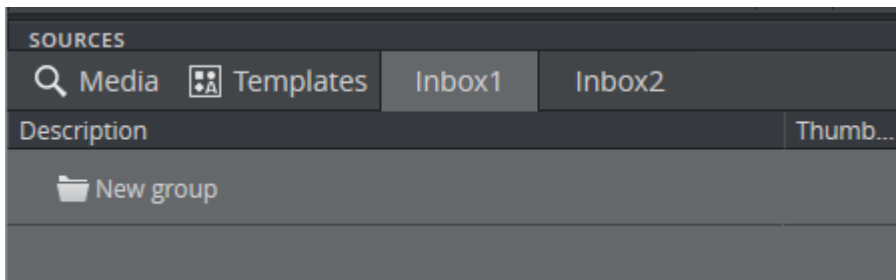

## 2.7.5 Servers

### Settings > Servers

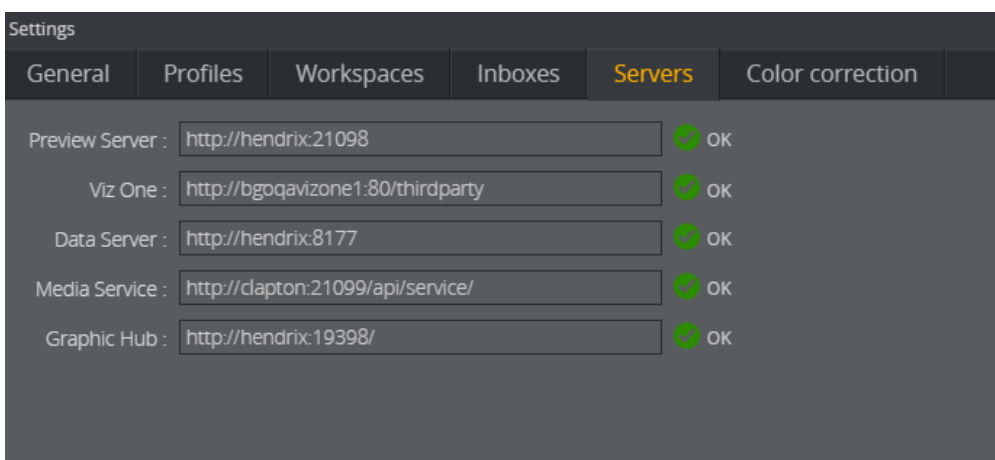

- Enter the URLs for the search providers that you want to use to search and preview media. The [Media Tab](#) search will then search in all sources and aggregate the results.
- The search providers that you configure will appear in the [Media Search Filters](#) in the [Media Tab](#). You can search in a subset of these sources by deselecting some of them in the [Media Search Filters](#).

**⚠ Note:** Multiple search providers can be used. However, we do not recommend configuring a Viz One and a Media Service simultaneously.

### Using the Pilot Data Server

If a Pilot Data Server is configured, you can access the Viz Pilot workflow. Access Viz Pilot concepts and templates by dragging templates from the [Templates Tab](#) to your channels.

## Server Connection Icons

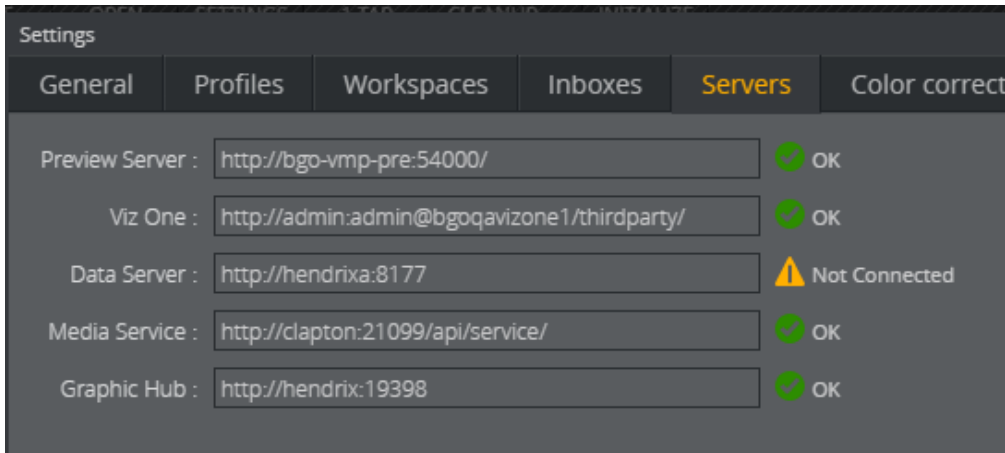

Icons next to the URL input boxes show the status of the connection to the server.

## 2.7.6 Color Correction

### Settings > Color correction

Correct colors for a monitor or group of monitors on a video wall:

- [Select Profiles and Walls](#)
- [Map Outputs to Monitors](#)
- [Create a Preset](#)
- [Adjust Colors and Other Options](#)

### Select Profiles and Walls

Load the wall you want to edit:

- Select the **Profile** and **Wall** from the drop-down menus:

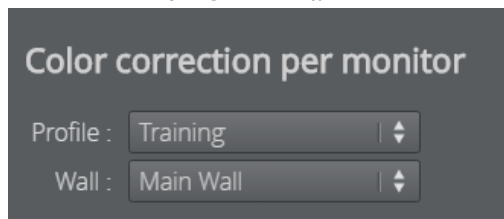

### Map Outputs to Monitors

Map outputs (1) to cubes (2). This is usually only done once.

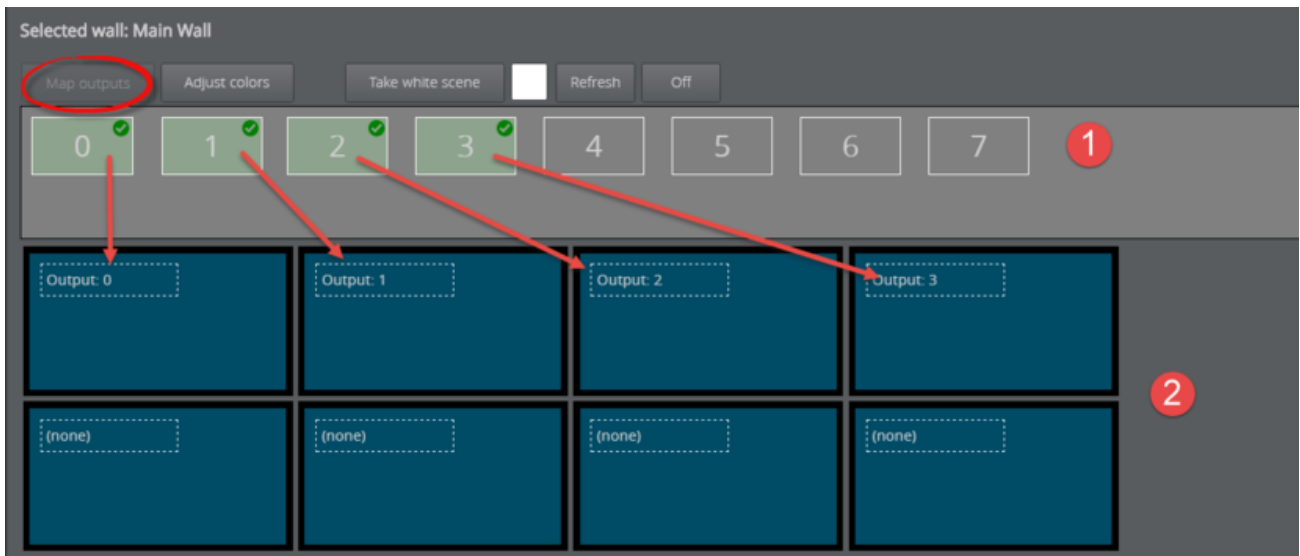

By cubes is meant the physical screens on your video wall. Drag outputs onto cubes to map them. For the sake of organization, the cube layout should ideally match the layout of the actual video wall.

**Note:** The **Map outputs** view opens by default as long as there are remaining outputs that need to be mapped. The **Color correction** tab always opens to the **Adjust colors** view once outputs are mapped.

The easiest way to match outputs with screens is to load a white scene.

1. Click **Adjust color** -> **Take white scene**. All monitors on your video wall now display white.



2. Click an output.

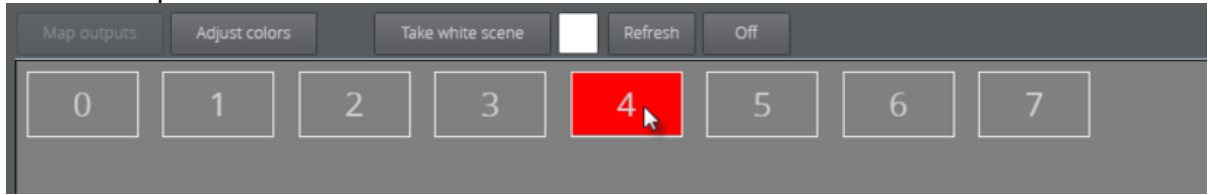

3. The video wall screen matching the output turns red. Below, the bottom left screen corresponds to output four:

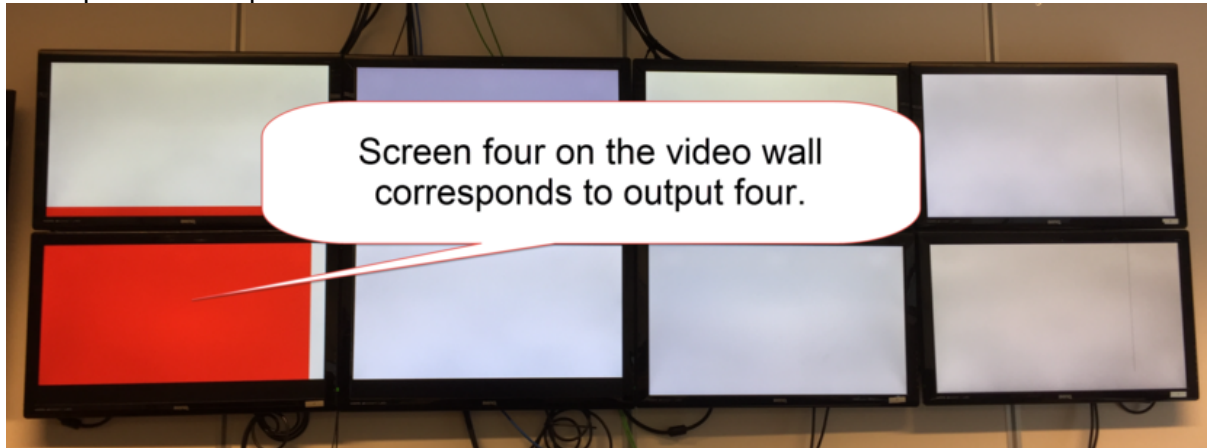



- Then drag the output to the same position in the editor to map.

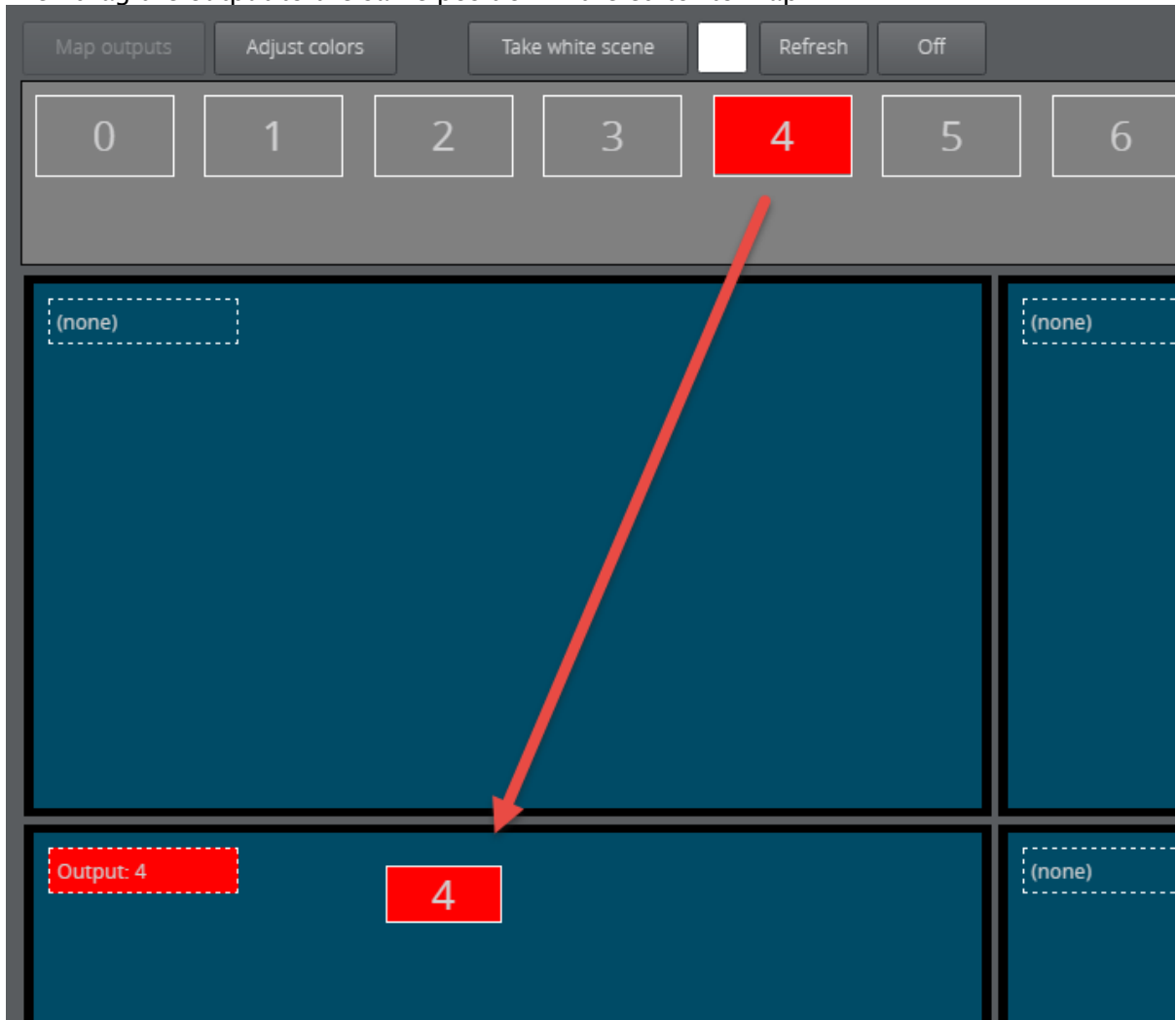

**⚠ Note:** Remember that graphics channels feed content to the screens. Channels are mapped to screens in the output. In the video wall above, output four is mapped to screen four, which could be receiving content from any GFX channel.

- Map output 1.

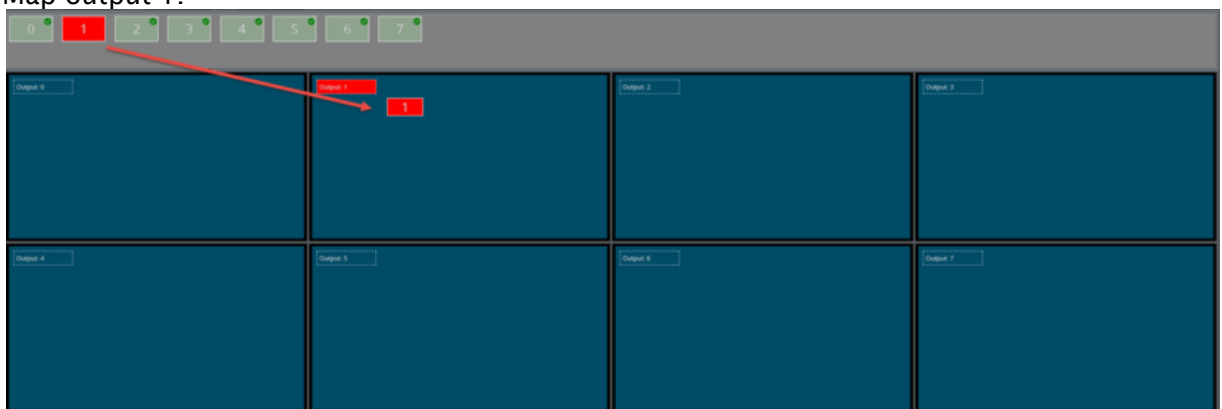

**Note:** The output turns green and a check mark appears when it's successfully mapped to a monitor.

**Tip:** Unmap an output by hovering the mouse over a mapped cube and clicking the red icon.

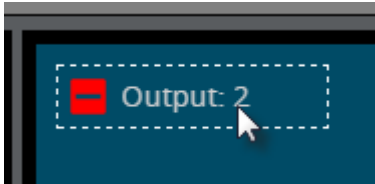

## Create a Preset

Create a color correction preset. This is useful in the case of multiple shows where each requires screens with different color intensity. A blue border appears around selected presets.

1. Click the **Adjust colors** button.

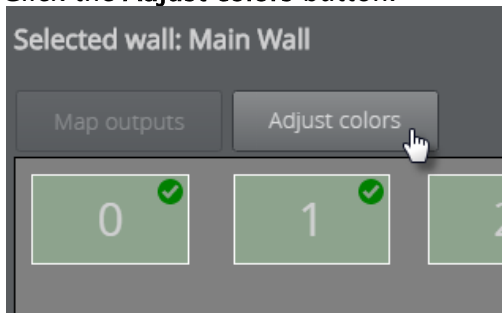

2. Click the **Add new color preset** button.

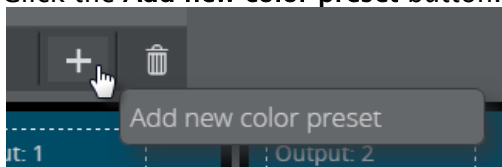

3. Give it a name and press **ENTER**.

## Adjust Colors and Other Options

Adjust screen color on a monitor-by-monitor basis.

**Note:** Color corrections are only visible on the physical screen and are not shown in Viz Multiplay. You should therefore use a physical video wall when adjusting color.

- Click a cube or screen to adjust its color:

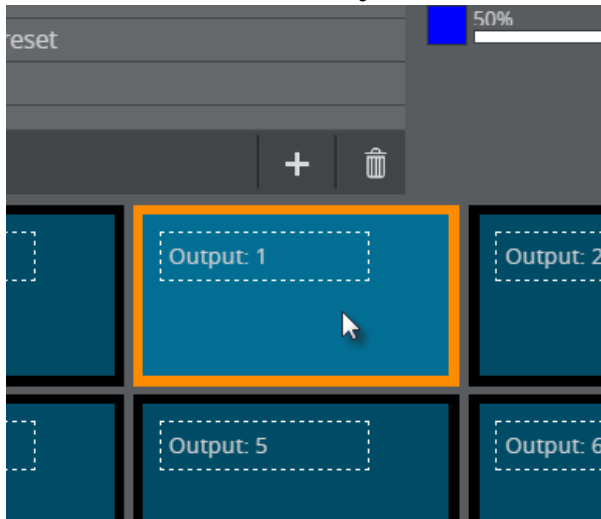

- Adjust colors in the menu below.
- Click **OK** to save the values for the selected preset.

**Note:** Changes in color correction cannot be canceled.



- Take white scene:** Take a completely white scene in the renderer.
- Select a color: Alter the background color of the current screen.

**Note:** The **Take white scene** button must be clicked to expose the color picker.

- Refresh:** Sent the configuration of entire preset (all monitors) to air.

**Note:** You can also send presets to air using commands in the media sequencer.

- Off:** Removes all currently-applied color corrections for the video wall.
- RGB sliders:** Click or drag along the slider to adjust the screen's RGB intensity. Select a value between 50 and 150 %, where 100% is default. For example, a 50% setting for red will deprive media in that screen of red.

**Note:** The luminosity in the color block next to the slider brightens or dims to reflect changes in luminosity. View the monitor on the physical video wall to see the changes in real time.

## Grouping Screens

Apply the same color correction edits to multiple screens.

1. In **Adjust colors** view, hold down **CTRL** and click the screens you want to group together.



2. Right-click a screen and select **Group**.

## Delaying Playout

Delay the playout in a Viz Engine:

1. Double-click an item in **Viz Engines** (1) or or expand a channel and double click an **Output** (2).

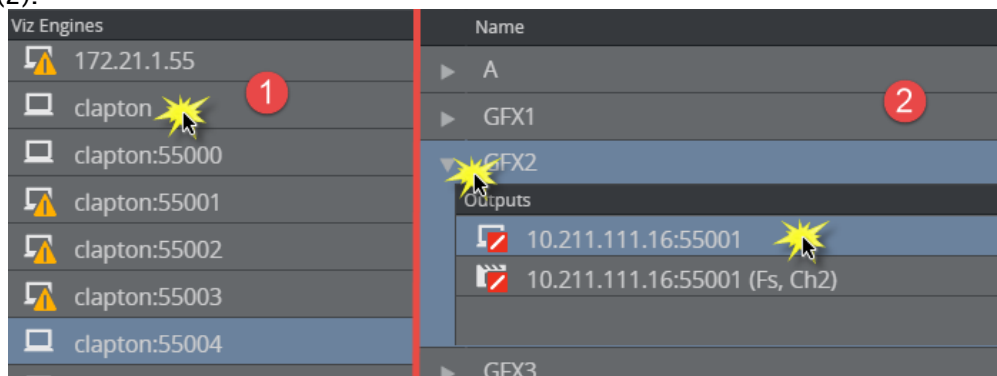

2. Enter a value in the **Delay** box.

The screenshot shows a dialog box titled "Edit Viz Engine" with a close button (X) in the top right corner. The dialog contains several input fields: "Host or IP" with the value "bgo-bull", "Port" with the value "6100", "Asset Storage" with a dropdown menu showing "(No Storage)", "Delay" with a text input field containing "1.5" (this field is circled in red), and "Mode" with a dropdown menu showing "Standard". At the bottom right of the dialog are "OK" and "Cancel" buttons.

Playback is delayed for the specified number of seconds, which could include fractions of seconds.

**Info:** Delayed playback is not frame accurate.

**Note:** The delay applies all attempts to play out elements in the channel from both Viz Multiplay, and other applications like Viz Trio or Director.

## 3 Workflows

This Chapter provides an overview of supported workflows in Viz Multiplay:

- Importing Graphics
- Setting Up and Organizing Content
- Preparing and Playing Out Content
- Working with Filled Presets
- Working with Viz Pilot and MOS Content
- Using a Switcher
- Using Graphic Hub Image Staging
- Tips and Tricks
- Editing Graphics, Videos and Images
- Arming and Taking Elements
- Organizing Media Content
- The Sources Pane
- Using Shortcuts

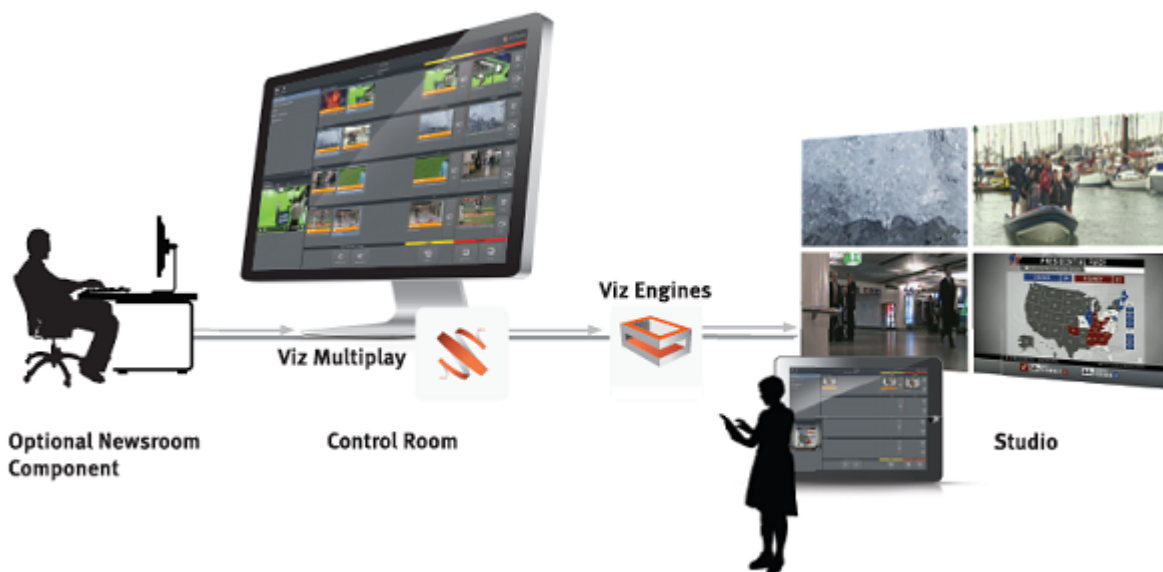

**Note:** All instances of Viz Multiplay are linked, so changes in one are reflected to all users. Users can **work in collaboration**: for example, a control room operator sets up elements for the studio presenter to take to air.

### 3.1 The Journalist

1. Prepare the show. Either:
  - Browse Viz Multiplay for content (images, clips and graphics) and add to a show.

- Prepare a show in Viz Trio or your newsroom control system.
2. Define the channel or channels on which the content will be triggered.

## 3.2 The Control Room Operator

Trigger the show as it was created in the rundown or rearrange elements on-the-fly:

1. Prepare a normal rundown in the control room or newsroom. Viz Multiplay is fully MOS enabled so clips can be managed through the normal newsroom workflow using our ActiveX component.
2. In Viz Multiplay, open a show.
3. Select and activate a profile.
4. Select and edit elements from the Sources pane. For example, media items, graphics, video wall layouts, or Viz Pilot templates.
5. Drag elements and arrange them in each channel:
6. Edit or preview the selected elements.
7. Drag or tap elements or video wall layouts to arm them, or take them to air: Viz Trio can trigger events from Viz Multiplay and control the content available in Viz Multiplay. Manual changes to the Viz Multiplay show are **immediately reflected** in the Viz Trio show and vice versa.

## 3.3 The Presenter

Control the output on screen using a tablet:

1. Select a media element to play.
2. Drag or tap elements to take them to air.

 **Note:** The presenter's tablet can automatically follow the control room's Viz Multiplay client to reduce the number of actions required by the presenter.

 **Note:** The physical video wall hardware is outside the scope of this chapter.

## 3.4 Importing Graphics

In a Vizrt system, graphics are created in Viz Artist and saved as scenes. The scenes are stored in Viz Graphic Hub. The scenes can contain control fields that the scene designer decides to expose to the user which contain default values. This is the general process for playing out a scene with custom control field data (for example, specifying a name and picture on a nameplate):

- In a control client (for example Viz Trio, Viz Pilot or Viz Multiplay) the user must browse to a scene in Viz Graphic Hub and *import* it.
- The control client stores its own representation of the graphical scene in its backend (in a Viz Pilot Database or in the Media Sequencer). They are stored as *templates*.

- In a daily context, a user opens the control client, selects a template, fills in custom data in the control fields and stores a specific instance of the template as an *element*.
- The element can then be played out on a Viz Engine as a part of a broadcast. For instance, overlay graphics with the name and title of a person being interviewed.

There are three ways of accessing graphics in Viz Multiplay:

1. Import graphics directly into Viz Multiplay. See [Basic Scene Import](#) below.
2. Use Viz Trio to import scenes and create pages usable within Viz Multiplay. See [Working with graphics](#).
3. Use a Viz Pilot system and access the graphics via templates and elements in the [Templates tab](#).

### 3.4.1 Basic Scene Import

In Viz Multiplay, it is possible to do basic scene import from the Graphic Hub directly into the GFX source tab or the Shortcuts tab or directly into any channel. To import a scene into the GFX source tab:

- Create a new group.
- Click the **Import graphics** button 
- In non-empty groups, right-click anywhere in the group and select **Import graphics** to start the import process:

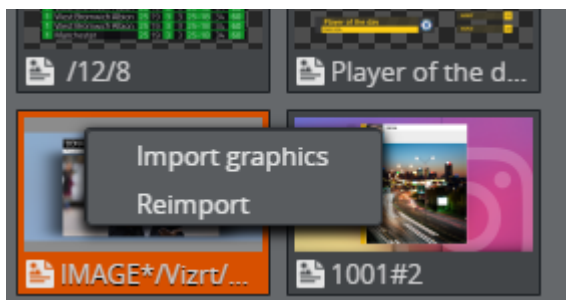

The import window now appears. This window contains all the scenes created in Viz Artist. Search for the scene with free text and click **OK**.



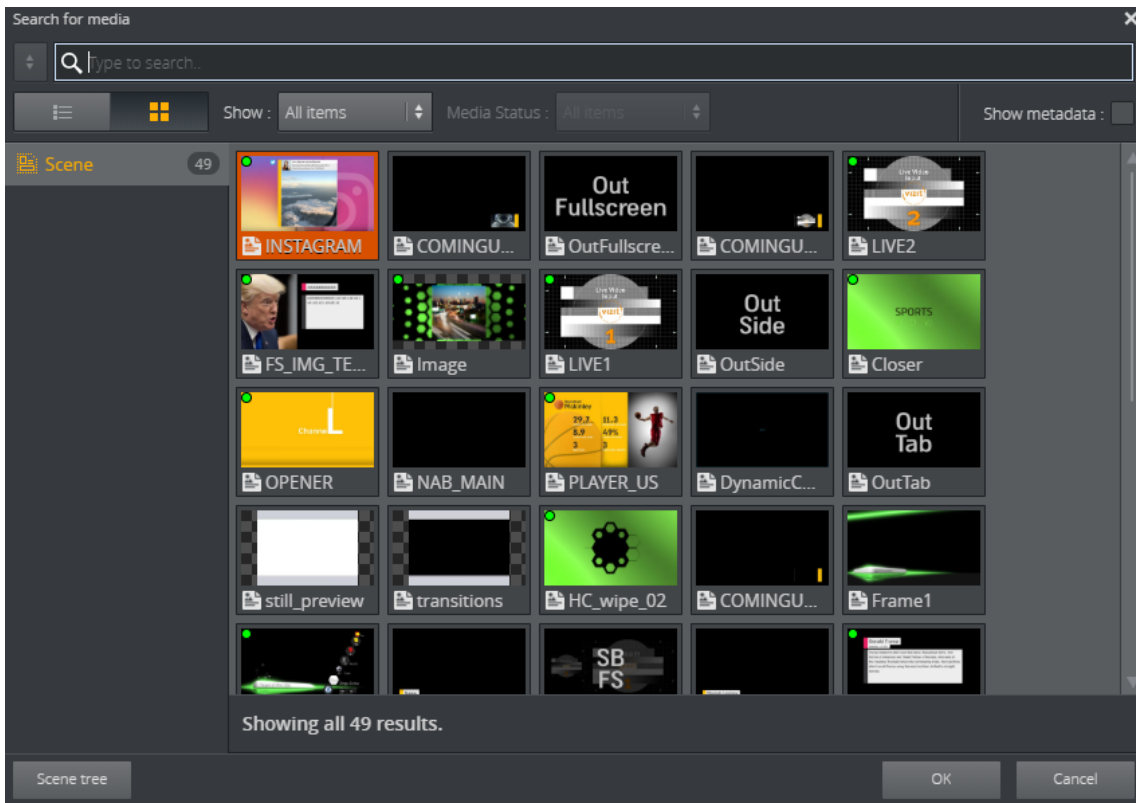

It is also possible to browse the scene tree in Viz Graphic Hub. Click the **Scene tree** button to switch to the scene browser:

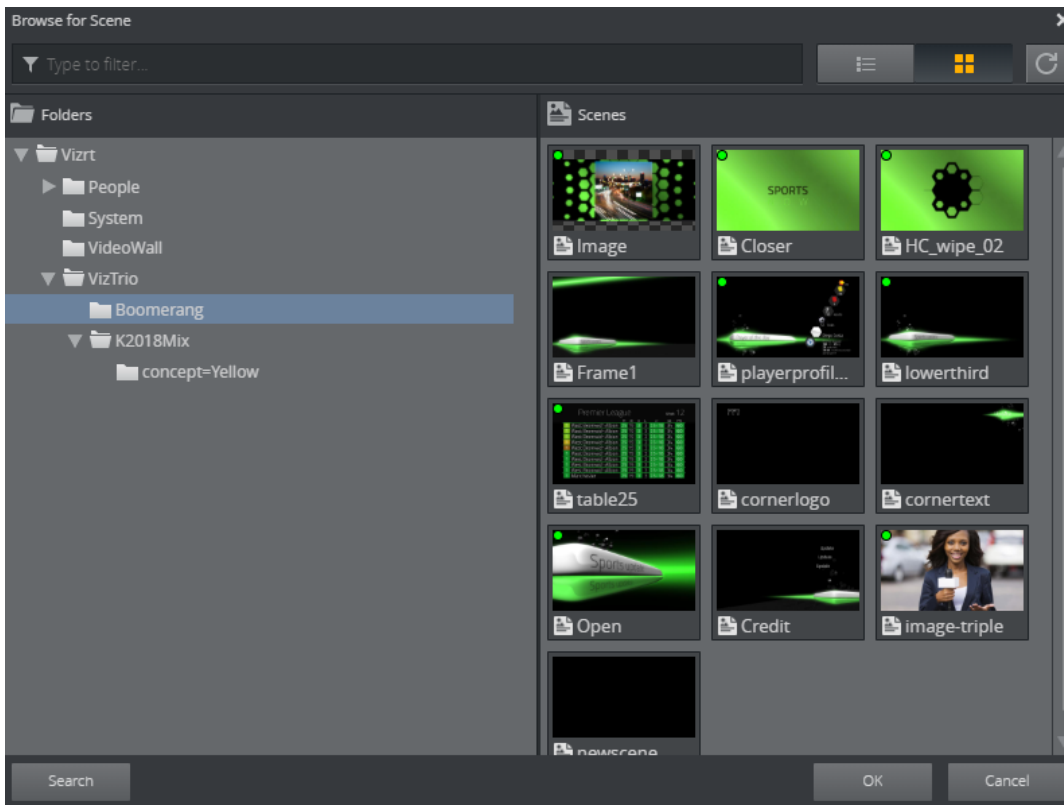

Click **Search** to switch back to the search window again.

Scenes that are already imported into the currently opened show are marked with a green dot:

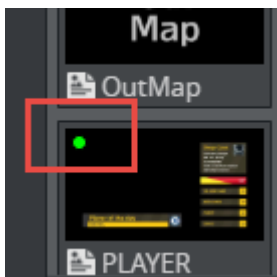

Importing a scene with a green dot will create a new instance of the template in Viz Multiplay. For instance, you may want several instances of this scene available in the GFX source tab with different default data. A good example is importing a nameplate graphic several times, and editing the different templates to contain names that are frequently used:

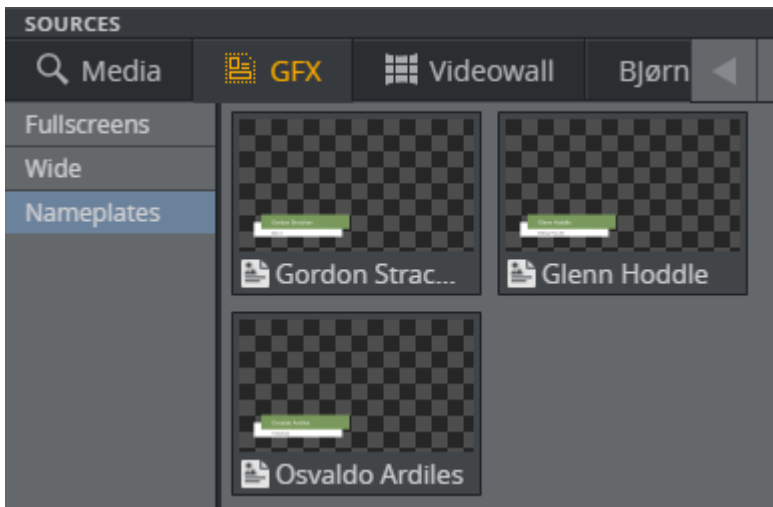

## Reimport Graphics

If the scene designer changes the scene, for instance by adding or removing a control field, the scene must be re-imported. This can be done by right-clicking any instance of the scene in the GUI (in a channel, in the Shortcuts panel or in the GFX source tab) and selecting **Reimport**:

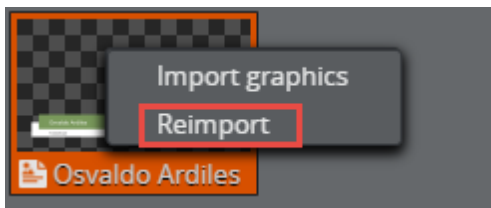

The result is that the scene is re-imported from Graphic Hub, and all elements based on this scene are now changed. The change is visible when editing the element in the Fill in form for graphics. If a control field is added, the elements based on the re-imported scene will contain default data specified by the scene designer in Viz Artist.

---

## 3.5 Setting Up And Organizing Content

This section covers how to import graphics and set up servers to fill Viz Multiplay with content ready to be played out on the video wall.

The following topics are covered in this section:

- [Using Custom Thumbnails for Media Elements](#)
- [Setting Up a Preview Server](#)
- [Working With Shows and Profiles](#)
- [Shortcuts](#)
- [Working with Graphics](#)
- [Inboxes](#)
- [Working with Images and Videos](#)
- [Edit Graphics, Videos and Images](#)

### 3.5.1 Using Custom Thumbnails for Media Elements

All media elements (images, graphics, clips), can have their own custom thumbnail. This is useful for elements that are used often or have a special significance to the operator, or if the thumbnail generated by default is not adequate.

#### Assigning a New Thumbnail to Media Elements:

- Right click any media element
- Select **Set thumbnail**
- Upload a new thumbnail from file, or
- Enter a URL to a thumbnail, or
- Revert to the default thumbnail

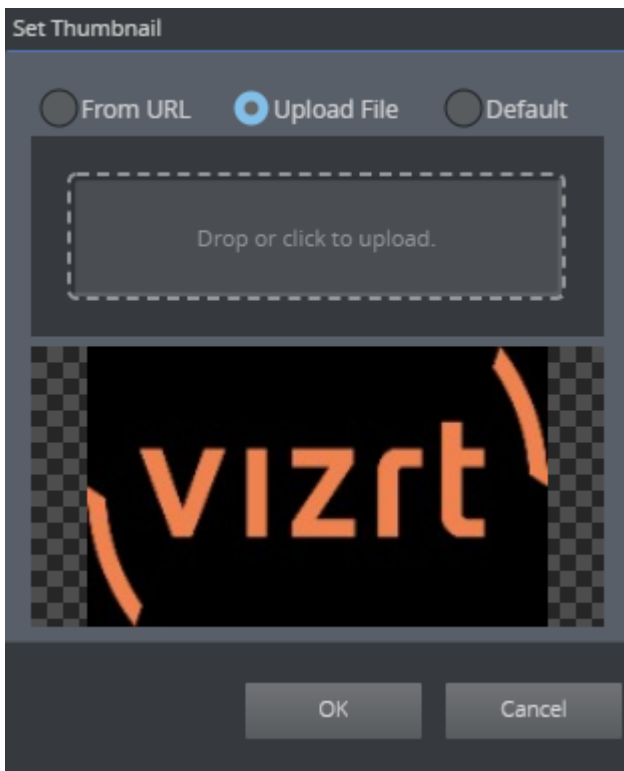

### 3.5.2 Setting Up a Preview Server

The Viz Multiplay GUI contains thumbnails for video clips, images, graphics and other elements.

Video clip and image thumbnails are fetched from the asset management system; graphics thumbnails are generated on the fly by Preview Server, which ensures that the thumbnails contain the actual element data:

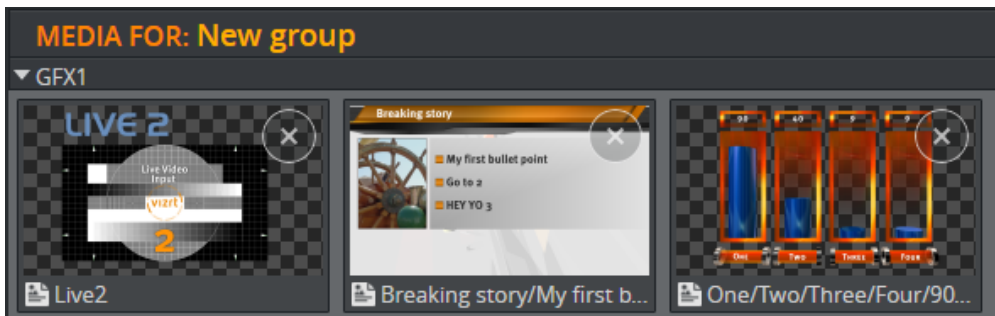

**Note:** Graphics thumbnails remain blacked out if no Preview Server is configured.

**Tip:** Viz Multiplay uses the Preview Server configuration in Media Sequencer. No actions need to be taken in Viz Multiplay if you are using Media Sequencer with a pre-configured Preview Server.

## Running Preview Server

A separate Viz Engine in VGA mode is required to run Preview Server.

**Note:** If a Viz Engine is used to generate snapshots for Preview Server, it cannot simultaneously perform other tasks such as running Viz Trio or Viz Artist.

1. Once a Preview Server is up and running, click **Settings > Servers**.
2. Enter the hostname of the Preview Server in the input field:

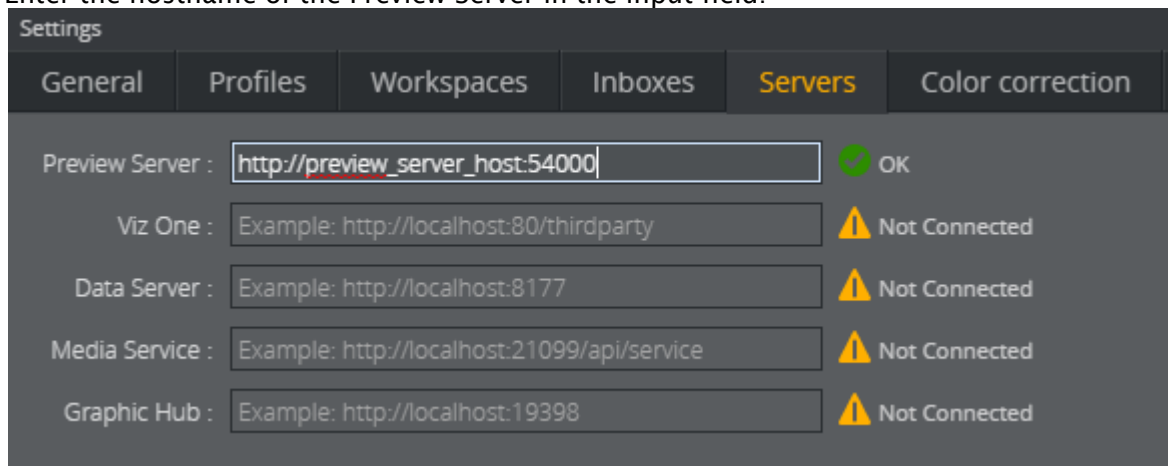

3. Press the **TAB** key. Viz Multiplay will fill out the rest of the URL.
4. Click **OK**.
5. The thumbnails will now appear on the GUI if you have graphics in your show or playlist.

✓ **Tip:** Viz Engine normally generates snapshots requested by Preview Server very quickly. However, it may take a few seconds before the thumbnails appear if your show or playlist contains a large number of elements. The HUI will refresh more quickly once thumbnails are cached in Preview Server or the web browser.

✓ **Tip:** Bear in mind that the Preview Server is connected to one or more Viz Engines that are connected to one Graphic Hub database with the scenes and resources. When importing graphics from different sources like Viz Trio or Viz Pilot Data Server, the scenes used in these graphics must be stored on the Graphic Hub used in the Preview Server. It's best to have only one Graphic Hub on the system that contains all your graphics.

### 3.5.3 Working With Shows and Profiles

Creating shows and profiles involves the following steps:

- [Create a New Show](#)
- [Create a Profile](#)
- [Create Playout Channels in the Profile](#)
- [Activate the Profile](#)

#### Create a New Show

The first step is to create a new show.

1. Click the **New** button:



2. Give the new show a name.
3. Click **OK**.

⚠ **Note:** The show structure in Viz Multiplay is compatible with a Viz Trio show.

The [Show Pane](#) now has one tab with a **Page List**:

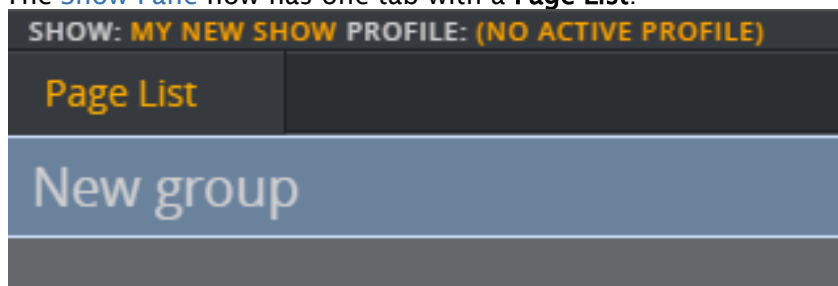

**Page List** displays the content of the page list in the Viz Trio show. Create additional playlists as required.

## Differences between Viz Trio and Viz Multiplay Page Lists

- In Viz Trio, the page list is mostly used to host pages with unique callup codes, while in Viz Multiplay the page list is a free structure that can contain any type of element with any name.
- Viz Trio displays the page list and playlists as a tree, while Viz Multiplay organizes the playlist per channel. For instance, all elements in a group assigned to GFX2 are placed in the row representing GFX2 in the GUI in Viz Multiplay. You must therefore create and activate a profile for your show in Viz Multiplay containing the channels Viz Multiplay needs to organize the elements.
- Viz Multiplay does not display any playlist or page list elements in the root group. All elements must be placed in groups to appear in the GUI.

## Create a Profile

A profile with Output channels is required. Viz Multiplay creates one row for each channel in the GUI. The profiles you create in Viz Multiplay are compatible with any Media Sequencer client that uses profiles, such as Viz Pilot or Viz Trio.

1. Click **Settings > Profiles**.
2. Create a new profile by clicking the **Add (+)** button at the bottom of the Profiles list.
3. Enter the name of the new profile.

## Create Playout Channels in the Profile

There are two ways to create playout channels in the profile:

1. **Create channels manually (usually for a non video wall scenario):** Add Viz Engines and Video Engines in the window to the right in the Profile Configuration. Next, create channels in the window in the middle and drag engines over to the channels. A single channel can contain multiple Engines.
2. **Create a video wall:** Channels and engines are created automatically.

## Activate the Profile

You must activate the profile for a show in order to view the output channels in the GUI. Once activated, the Media Sequencer actively takes control over the show resources - monitoring and transferring clips and scene resources to the Viz Engine.

 **Note:** Since activation can be a demanding operation for Media Sequencer if a show contains many assets, it's recommended to activate the profile before the show starts and deactivate it after the show has ended.

1. Go to **Settings > Profiles**.

2. Click the **Activate** button for your profile.

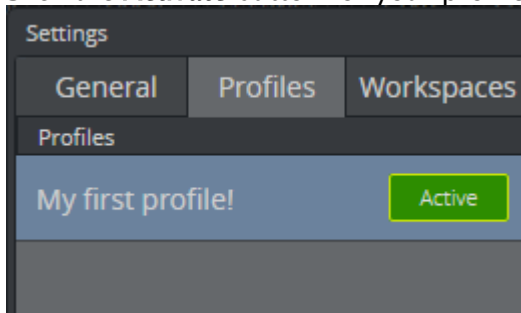

**Note:** Since activating a profile is a Media Sequencer operation, your show will be activated for all clients who have the show open. Your show can only be active in one profile.

### 3.5.4 Shortcuts

When a new show is created, Viz Multiplay generates a special playlist called **shortcuts**. The shortcuts playlist is a regular playlist with groups and elements.

If desired, you can select a different playlist to be the shortcuts playlist under **Settings > General**. Select a playlist from the **Shortcuts** dropdown:

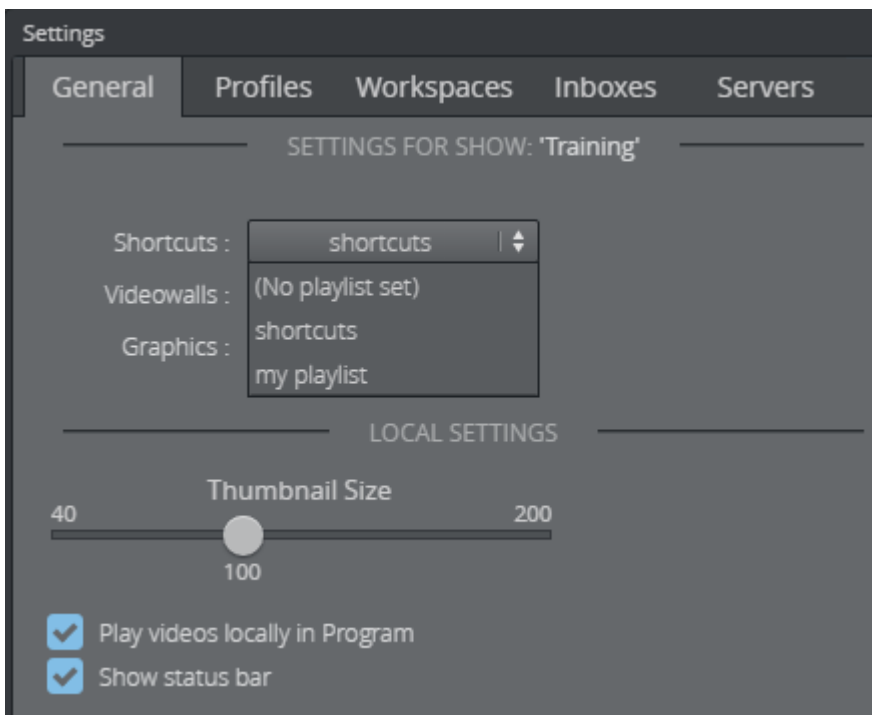

The shortcuts playlist appears in the [Using Shortcuts](#). Each tab is a group in the playlist.

Create a new group in Viz Trio or click **Settings > General** and remove it as the shortcuts playlist. Select **(No playlist set)** as the value in the **Shortcuts** dropdown. It now becomes a regular playlist in Viz Multiplay, where you can add or remove groups.



Unlike other channel groups in Viz Multiplay, playlists in the Shortcuts bar are not assigned to a specific channel. Elements in the shortcuts bar play out on the channel assigned for each element. This means that if you drag an element from the GFX playlist directly to the Shortcuts bar, the element will keep its assigned channel. If the element has no assigned channel, it will play out on the Program channel in the profile.

- ✓ **Tip:** The Shortcuts bar normally contains the video wall presets, “filled” video walls (presets with content) and backgrounds. These should be played out on the main channel of the video wall using the defaults from Viz Multiplay. The main channel is called **A**. Right-click elements on the Shortcuts bar to ensure that they have the correct playout channel.

### 3.5.5 Working with Graphics

Import graphics from Graphic Hub.

#### Basic Scene Import

For basic scene import (without support for Transition Logic) - use the Import scene function directly in Viz Multiplay to import graphics created in Viz Artist. Right-click anywhere and select **Import graphics**:

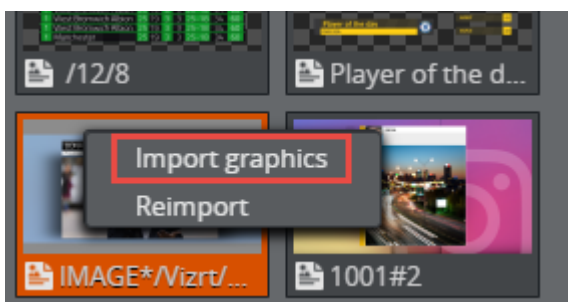

#### Importing Scenes with Viz Trio

Graphics can be imported into Viz Multiplay using Viz Trio. This is handy if you need to import Transition Logic scenes or already have a graphics system running with Viz Trio. In Viz Trio:

1. Select **Import Scenes** in the Page Editor menu.

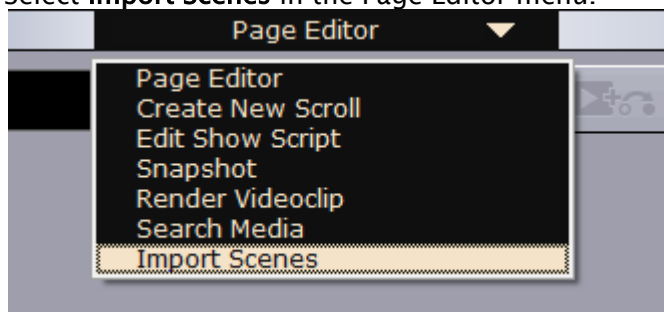

2. Browse the scene tree in Graphic Hub and import the scenes you want to use.

**Note:** You now have one template per scene you imported. These are not visible in Viz Multiplay.

3. Create a page for each of the templates.

**Note:** These pages end up on the root level of the page list in Viz Trio and are not visible in Viz Multiplay. To make them visible, move the pages into groups.

### 3.5.6 Inboxes

Inboxes are global shows that are always available in the Sources pane. They can contain any type of element (images, clips and graphics), and the content does not need be placed in groups.

#### Inboxes are Typically Used

- For a special show that is a target for Sequencer Ingest. New ingested material then appears automatically in the inbox, ready to be used in Viz Multiplay.
- For listing available live source elements. These can be dragged to any group channel in Viz Multiplay and played out.
- For graphics created during a broadcast or event that are imported by a Viz Trio operator into the inbox show. The graphics are then instantly available in Viz Multiplay.

#### Use a Show as an Inbox

1. Click **Settings > Inboxes**.
2. Create a new show or select an existing show.

3. Drag the show over to the **Inboxes** list to the right.

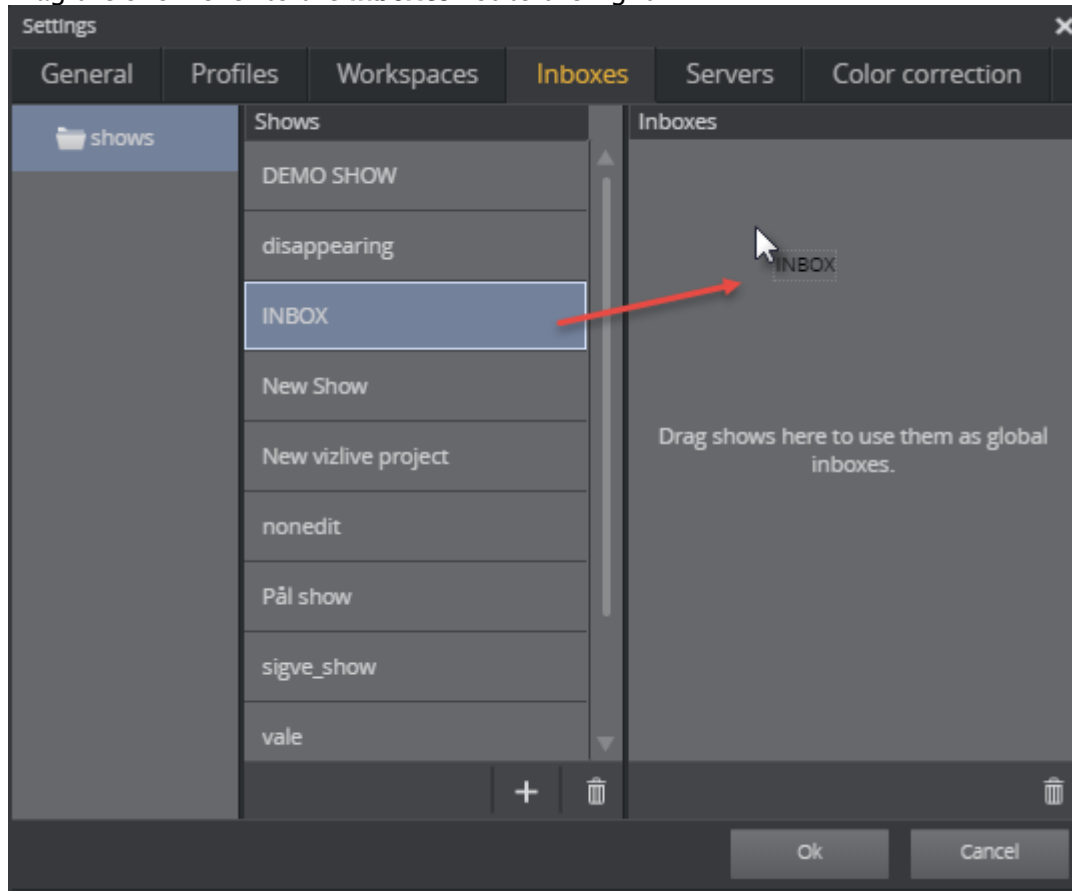

4. The show now appears in the Sources pane:

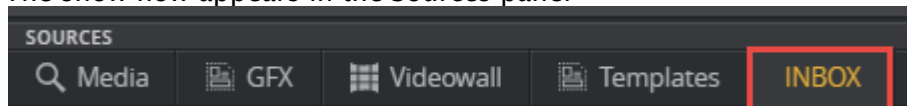

### 3.5.7 Working with Images and Videos

**Note:** A MAM system such as Media Service, Viz One or a Graphic Hub REST service (images only) is required in order for Viz Multiplay to access media assets.

Once a MAM system is up and running:

1. Go to **Settings > Servers**.
2. Enter a hostname in the input field for the service.
3. Press TAB, and Viz Multiplay will fill out the full URL.
4. Click **OK**. The **Media Tab** in the Sources pane now contains your MAM system as a search provider.

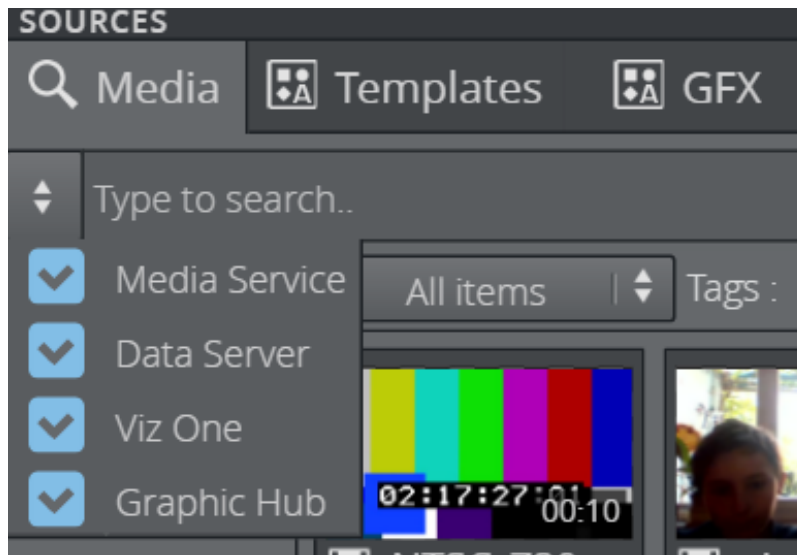

## Setting Asset Storage

The Viz One setting is global for Media Sequencer. When asset storage is configured, the Media Sequencer starts to monitor shows and playlists and transfer assets to the Viz Engines.

**Note:** If you have a Viz One system, you also need to set Asset Storage in the video wall dialog box by clicking **Settings > Profiles** and double-clicking the video wall in the selected profile.

**Note:** If you don't have video walls, the Asset Storage must be set for each Viz Engine and Video Engine in the list to the right. Failure to do so will result in videos not being transferred to the Viz Engine.

## Configuring Media Service by Entering the Hostname in Media Service

1. Click **Settings > Servers**.
2. Enter the Media Service URL (or hostname) in the Media Service input field.

This setting is only visible to Viz Multiplay and is not shared with Media Sequencer, which will not register asset storage as configured. Since Media Service is designed to host its clips on the clip root of the Viz Engine, clips do not need to be transferred and it is therefore not necessary for asset storage to be registered by Media Sequencer. However, since error messages may appear from MSE and in Viz Trio, another way of configuring Media Service is outlined below:

## Configuring Media Service by Entering the Hostname in the Viz One Input Field

1. Click **Settings > Servers**.
2. Enter the Media Service URL (in addition to the hostname) in the Viz One input field.

The Media Sequencer now thinks it is communicating with a Viz One service - and Media Service uses the same API as Viz One even though no file transfers are needed. You can use this method if it is OK that the Media Sequencer is configured with Media Service. Bear in mind that this configuration is common to all Media Sequencer users.

If you use Media Service, all the Viz Engines must use the Media Service clip folder as their clip root - as a shared disk. This can affect playout performance. If you have a single Viz Engine, Media Service is well suited to run on the same computer as the Viz Engine, where they both have access to the local clip root folder.

**Note:** If you have set up a **Graphic Hub REST service** you have access to images in the Graphic Hub. The play-out performance will be best for these images as they can be pre-loaded. Images from Viz One and Media Service are loaded when they are played out, which can cause a short delay.

Configure all search providers and limit searches using the boxes in the search provider's list in the search panel:

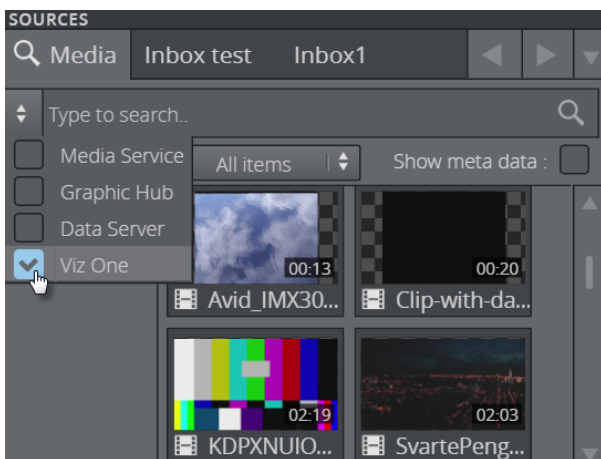

### 3.5.8 Edit Graphics, Videos and Images

If a show is prepared properly and an asset provider is set up, you can add and edit elements during a broadcast or event.

This sub-section covers the following topics:

- [Example Workflow](#)
- [Editing Elements](#)
- [Setting In and Out Points in Video Clips](#)
- [Zooming and Cropping Images](#)
- [Editing Graphics](#)

#### Example Workflow

##### In Viz Trio

1. Prepare a show by importing scenes from Graphic Hub into the show. These scenes become templates in the show.

2. Create pages for the most frequently used graphics and drag them into groups in the GFX playlist.
3. These pages are now available in Viz Multiplay.

### In Viz Multiplay

1. During the broadcast or event, select the page list or a playlist in the [Show Pane](#).
2. Click a group. Each group channel is now populated with the relevant elements.
3. The Viz Multiplay operator needs a new element (a video, an image or graphics) and finds it in a source (Media tab, inbox, GFX playlist, etc.) before dragging it into the channel where it will be played out.
4. The operator can now edit the element by right-clicking and selecting **Edit**.

### Editing Elements

**Caution:** Changes made to elements being edited are made in real time on the elements in the Media Sequencer for all operations. These changes are saved immediately and it is not possible to undo them.

**Tip:** Copy an element by dragging it and pressing **CTRL**.

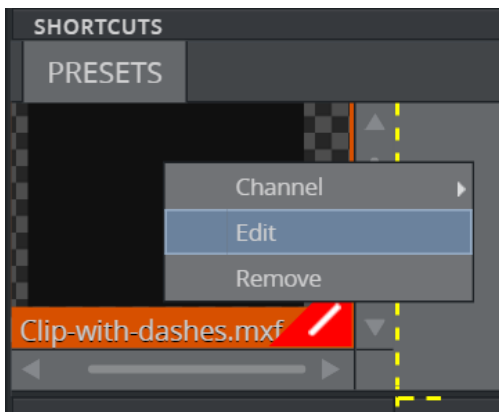

### Setting In and Out Points in Video Clips

Scrub through video clips and set new in or out points:

1. Drag a video into the channel where it will be played out.
2. Right-click the video and click **Edit**.
3. Scrub in the timeline to where you want to set an in point.
4. Click the **Set Mark In** icon or press the **i** key to set an in point.

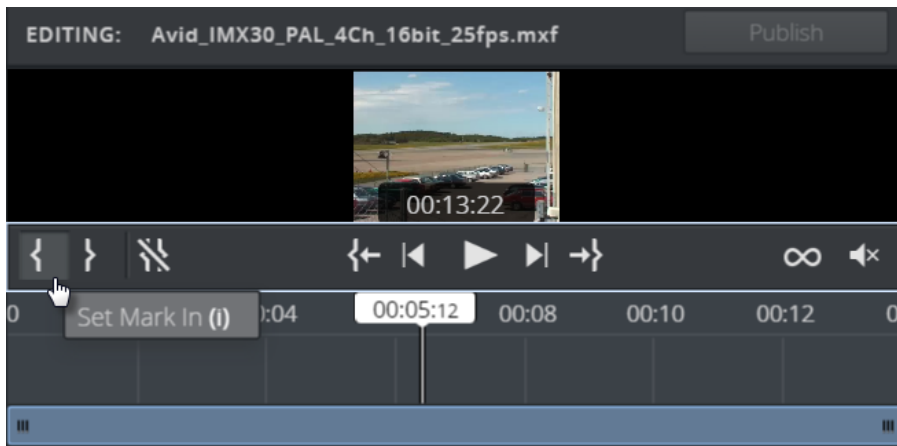

5. Click the Set Mark Out icon or press the **O** key to set an out point.

## Zooming and Cropping Images

Add a zoom or crop effect to images:

1. Drag an image into the channel where it will be played out.
2. Right-click the image and click **Edit**.
3. Click either **Crop** or **Animation**.

## Editing Graphics

For graphics, the operator can enter data in the fields exposed by the scene designer.

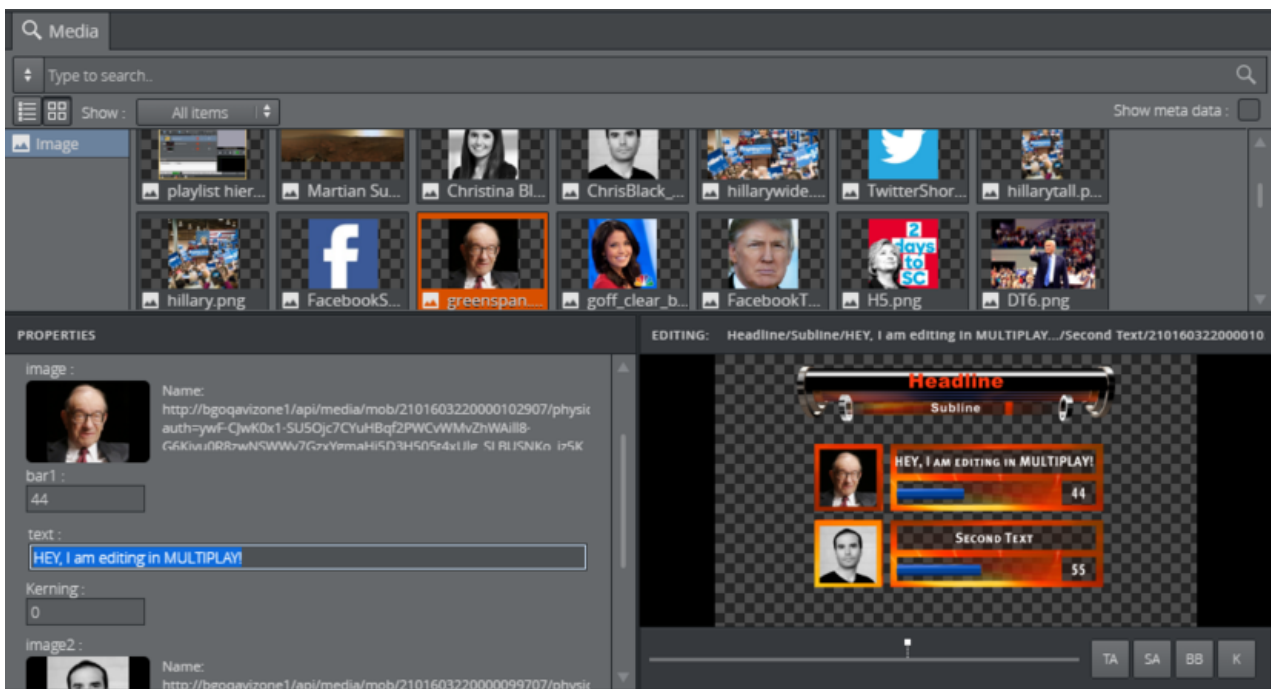

See Also

- [Editing Videos](#)
- [Importing Graphics](#)
- [Editing Images](#)
- [Preview Server Administrator Guide](#)

## 3.6 Preparing And Playing Out Content

This section covers:

- [Preparing Content](#)
- [Cleaning up the Renderer](#)
- [Playing out Content](#)
- [Transitioning Content between Armed and Program](#)
- [Auto-playlist](#)

### 3.6.1 Preparing Content

#### Initializing



Initializing means that the renderer will load all resources needed to play out the graphics into the memory, so they will appear instantly when taken on air. The Initialize function works the same way as it does in Viz Trio. If the graphics are not loaded, it may take some time before the renderer plays the graphics when a Take operation is executed.





It's also possible to initialize single scenes by right-clicking the thumbnail and selecting **Initialize**.

**⚠ Note: Initialize** loads content but does not refresh it. If changes have been made to a scene that was already loaded, a **Cleanup** renderer command must first be issued, followed by an **Initialize** command. If single scenes need to be reloaded from the Graphic Hub, right-click the thumbnail for the element and select **Reload Scene**.

#### Initialize a Show

To initialize a show, click the **Initialize** button. The button shows the status and progress of the loading process:

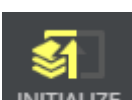

Icon	Status
	Action needed. No scenes are loaded on the renderer. Click the button to start the process.
	Action needed. Scenes are partly loaded on the renderer, but the loading operation is currently not active. Click the button to start the process.
	No action needed. The scenes are partly loading, and the loading process is active. Hover your cursor over the button to view detailed progress status.
	No action needed. All scenes are loaded into the renderer.

Hovering your cursor over the **Initialize** button makes a tool tip with more detailed loading progress appear:

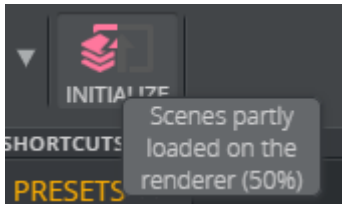

**Warning:** Initializing during a broadcast may impact the frame rate of scenes playing On Air. Initializing should be done in advance or when Off Air in order to avoid affecting the content in the renderer.

## Initializing Elements

It's possible to initialize single graphic elements and filled presets in Viz Multiplay by right-clicking the graphics and selecting **Initialize**:

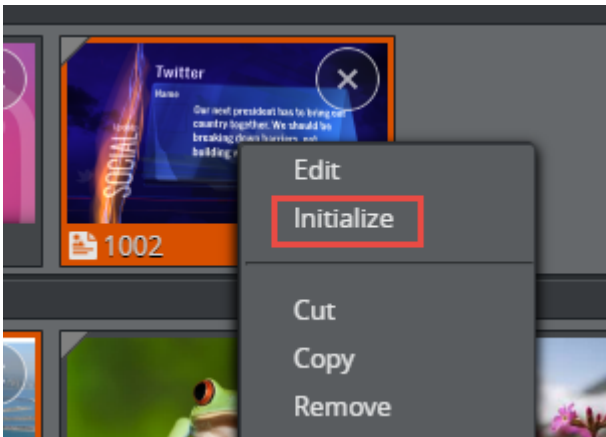

**Warning:** Initializing single elements will likely affect the frame rate on the renderer. Flickering or frame drops may occur.

## GUI Feedback

The colored symbols in the upper left corner of the elements in the Media column will indicate whether the element is not loaded (gray), partially loaded (yellow) or fully loaded (green) on the renderer.

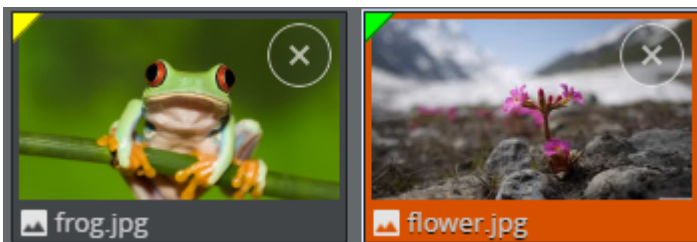

The initialized status in the Media Pane shows the loaded status for graphics. Clips may remain unavailable even if the graphics are loaded. For filled presets: although there may be a green status for the graphics, some of the clips may still be unavailable:

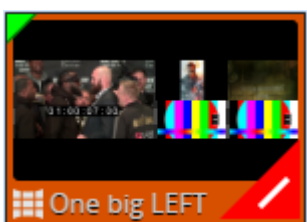

Clicking the red error mark, or hovering your cursor over it, will display detailed status on the availability of individual clips in the filled preset.

### 3.6.2 Cleaning up the Renderer

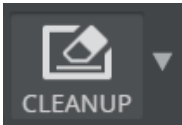

Clean up all video walls or a particular wall in a profile using the **Cleanup** button above. Cleaning up a wall unloads all the resources from the memory of the renderer, avoiding space issues and the inadvertent use of media from a previous session. Cleanup should be done before initializing a new show or in order to re-initialize the same show into the renderer's memory.

**Warning:** Cleanup also removes media for all other operators using the Media Sequencer.

- Clean up the renderer for **all** walls in a profile: Click the **Cleanup** button to clean up the renderer for all walls for the currently-active profile.

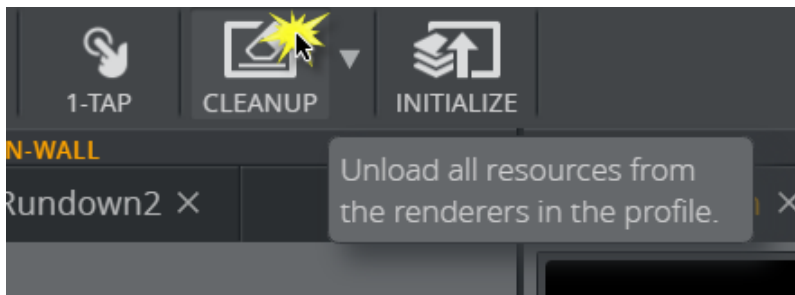

- Click **Yes** in the warning dialog that appears to clean up the renderer for **all** walls in a profile.

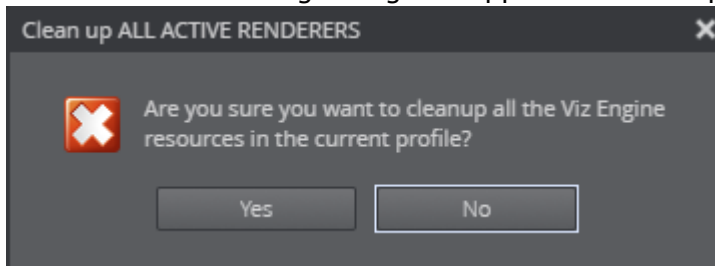

- Clean up the renderer for a particular wall in a profile: Click the **downward-facing arrow** in the cleanup button to expose a menu and select the wall you want to clean up.

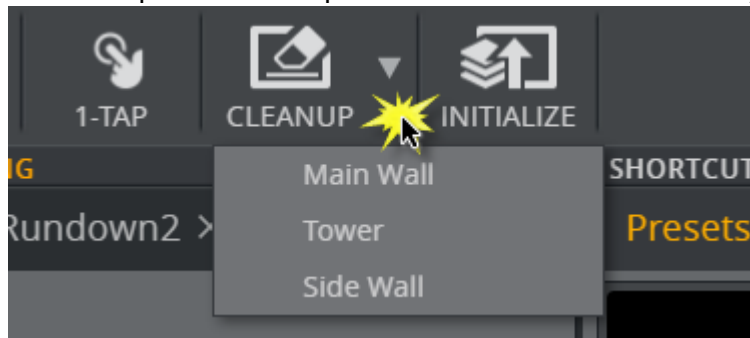

## Arming

You can arm elements, which means preparing them to be played on air, in Viz Multiplay. Armed videos are prepared by the MSE, so the first frame is ready in the renderer. Images and graphics are not pre-loaded in any explicit way. To arm elements, disable 1-Tap mode so the Armed column becomes visible.

Armed elements are visible in all Viz Multiplay clients connected to the same MSE. A conflict will arise if two operators want to arm their own private content on the same channel, ready to be played out. To resolve this it is possible to select different workspaces for the two operators. Armed elements are visible per workspace - if the first operator has activated his own workspace, his armed elements are not visible to the second operator in another workspace.

### 3.6.3 Playing out Content

There are several ways of playing out elements in the renderer. The simplest way is to click an element, which sends it to the armed column or directly on air if 1-Tap mode is enabled.

- ✓ **Tip:** Select elements manually from one or more groups and click **Take Selected** or **Arm Selected**. You can de-select elements by holding down the **CTRL** key.

Viz Multiplay also has another, more story-centric way of playing out elements:

1. Organize your material in groups, for example one group per story.

- ✓ **Tip:** Each group can have one or more elements placed in the order they will be played on air. Elements can also be assigned to the channel where they are to appear.

2. The first element in each channel will be selected when the operator clicks a group (story).
3. All the selected elements can now be played out or armed by clicking **Take Selected** or **Arm Selected**.
4. The selection now jumps to the next element in each group.
5. When this procedure is repeated, Viz Multiplay can be used as a tool for sequential payout of elements ordered in a story-centric fashion.

- ✓ **Tip:** There should always be a preset on air when using Viz Multiplay with video wall presets. The preset element plays out in the middle layer on the main channel of the renderer (normally host:6100). The GFX channels will not show without a preset On Air.

### 3.6.4 Transitioning Content between Armed and Program

It's possible to test content that you plan to play out on the actual video wall itself. You can do this by exchanging (swapping) the content in both columns. For instance, the Multiplay operator can prepare a set of media elements in the Armed column for playout when the wall is off air. If the Extra Armed button **TRANS** has been enabled, you can test the content on the wall by clicking the **TRANS ALL** button.

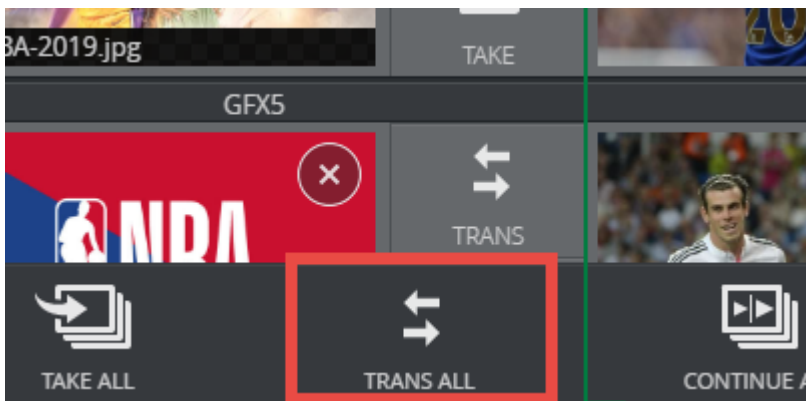

Any content currently in the Armed column will play out on the wall, while the media elements currently playing out on the wall will move to the Armed column. When the operator sees that everything is okay, a new click on the **TRANS ALL** button will toggle the content back again. The wall will then resume playing out the content from a minute ago, and the Armed column will once again contain the media elements that are ready to be played on air.

In this way, the operator can test content on the actual wall.

It is also possible to swap single elements by clicking the **TRANS** button in the Armed column:

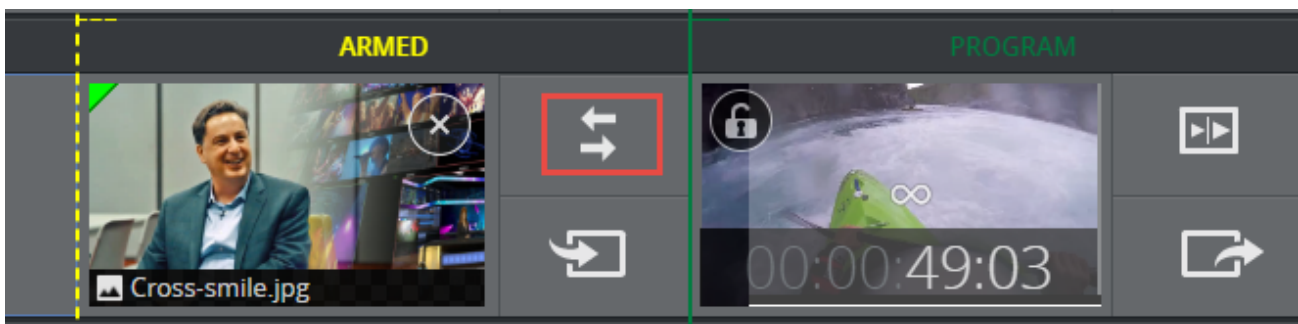

- ⓘ **Info:** If a channel in Armed does not contain any media elements when **TRANS ALL** is clicked, the existing content in the channel will remain on the Program engine. This ensures that the wall will never go black when **TRANS ALL** is used.

### 3.6.5 Auto-playlist

Viz Multiplay features an option to play out media elements automatically in succession. This can be handy if you have a set of media elements you want to loop on the video wall. Auto-playlists play out media elements in a specific channel, and the media elements must be a part of the same group.

#### To Create an Auto-playlist

- Create a group in a playlist where your media elements for the Auto-playlist will be placed.
- Drag media elements into this group. All media element types can be used in an Auto-playlist: Graphics, images, clips, and live sources.
- Right click each media element (or go to Off Air mode and multi-select media elements) and select **Add to Auto-playlist**:

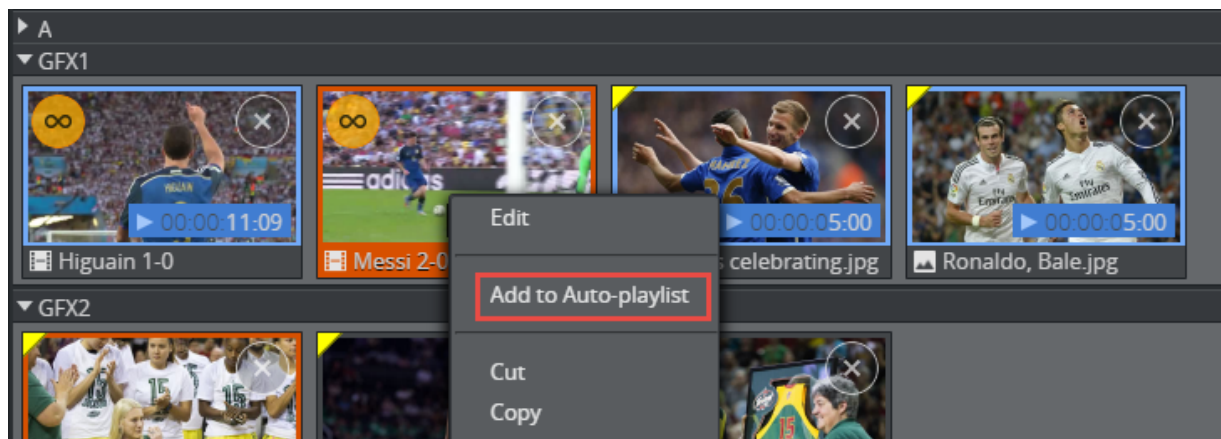

**Info:** Media elements added to an Auto-playlist have a blue duration field and a blue frame to differentiate them from regular media elements. The blue duration field shows how long the Auto-playlist element will stay in the renderer until the next element is played. The default duration for media elements is 5 seconds where no other duration has been specified.

- **To set a new duration for clips in auto-playlist:** Edit the clip and set a new mark in and/or mark out. The new duration of the clip will be used as the duration in the Auto-playlist.
- **To set a custom duration for other media elements in auto-playlist:** Right click the element and select **Set Duration**. A dialog will pop up prompting you to enter a number in seconds.
- **To reset the duration back to the default duration in auto-playlist:** Right click the element and select **Reset Duration**. The default duration for clips is the actual clip length between Mark in and Mark out. For images with an image effect, the default duration is the image effect duration. Although graphics may have a specific duration (for instance, if the graphic is a continuously running animation), graphics with stop points do not have a specific duration - all media elements added to an auto-playlist have a 5 second default duration if no other duration is specified.

✓ **Tip:** It's possible to add and remove media elements while an Auto-playlist is running.

## To Start and Stop an Auto-playlist

Once all media elements in a group have been added to the Auto-playlist, and the duration has been set on each element, you can start the Auto-playlist:

- Click one of the Auto-playlist elements. This starts the automatic playout of these elements.
- Each media element stays in the renderer for as long as the duration indicates. When the element is finished, the next element plays out.
- When the last element is finished, playout restarts from the first element.
- If a playlist contains a group with an Auto-playlist, a red blinking light at the top left indicates that it's running:

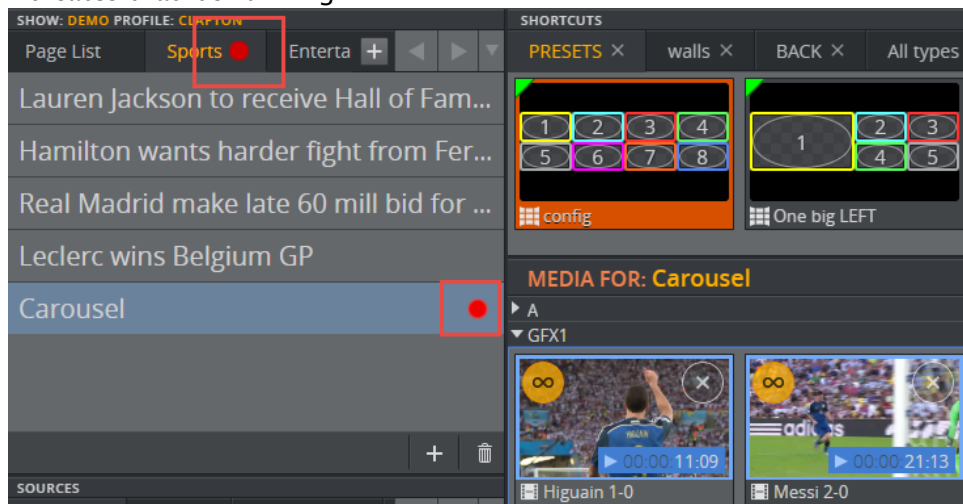

To stop an Auto-playlist, right click the Program column and select **Stop Auto-playlist**, or take the current element Out.

## 3.7 Working With Filled Presets

Presets describe the layout of the video wall regions (channels) on the video wall.

### 3.7.1 For Dynamic Walls, Presets with GFX Channels Are

- Regular graphic elements playing out the DynamicChannel scene, which keeps track of the position of GFX channels.
- Pages in a show that are not technically tied to one particular video wall configuration in a profile. Since the presets of a show will not be usable for a different video wall setup, presets created in a show should only be used together with one particular profile.

### 3.7.2 For Video Walls with Superchannels, Presets Are

- Regular playlist elements with a special master template, naming one preset in the Superchannel scene behind the master template.
- Each Superchannel video wall is represented by one Viz Artist scene, imported into Viz Multiplay as one master template.
- The Superchannel scene is imported in a profile.
- When opening a show and activating a profile, the presets must be imported into the show.
- The imported presets become invalid if a new profile is activated for the show.

 **Note:** Presets can be filled with content using both workflows.

This section covers the following topics:

- [Common Workflow](#)
- [Adapt the GUI for Pre-filled Walls](#)
- [The Preset Content Editor](#)

### 3.7.3 Common Workflow

#### Sample Workflow

1. Create a new group in the shortcuts playlist.

 **Note:** The shortcuts playlist already contains one group called **Presets**. You will now add an additional group for your pre-filled walls. This group will appear as a tab in the Shortcuts bar.

2. Drag a preset from the **Videowall** tab to your new group in **Shortcuts**, or the main channel (usually channel **A**).
3. Right-click the preset and select **Edit**.
4. You can drag and drop elements from the different tabs (Media, inboxes, GFX playlist) from the editor to the GFX channels in the video wall.



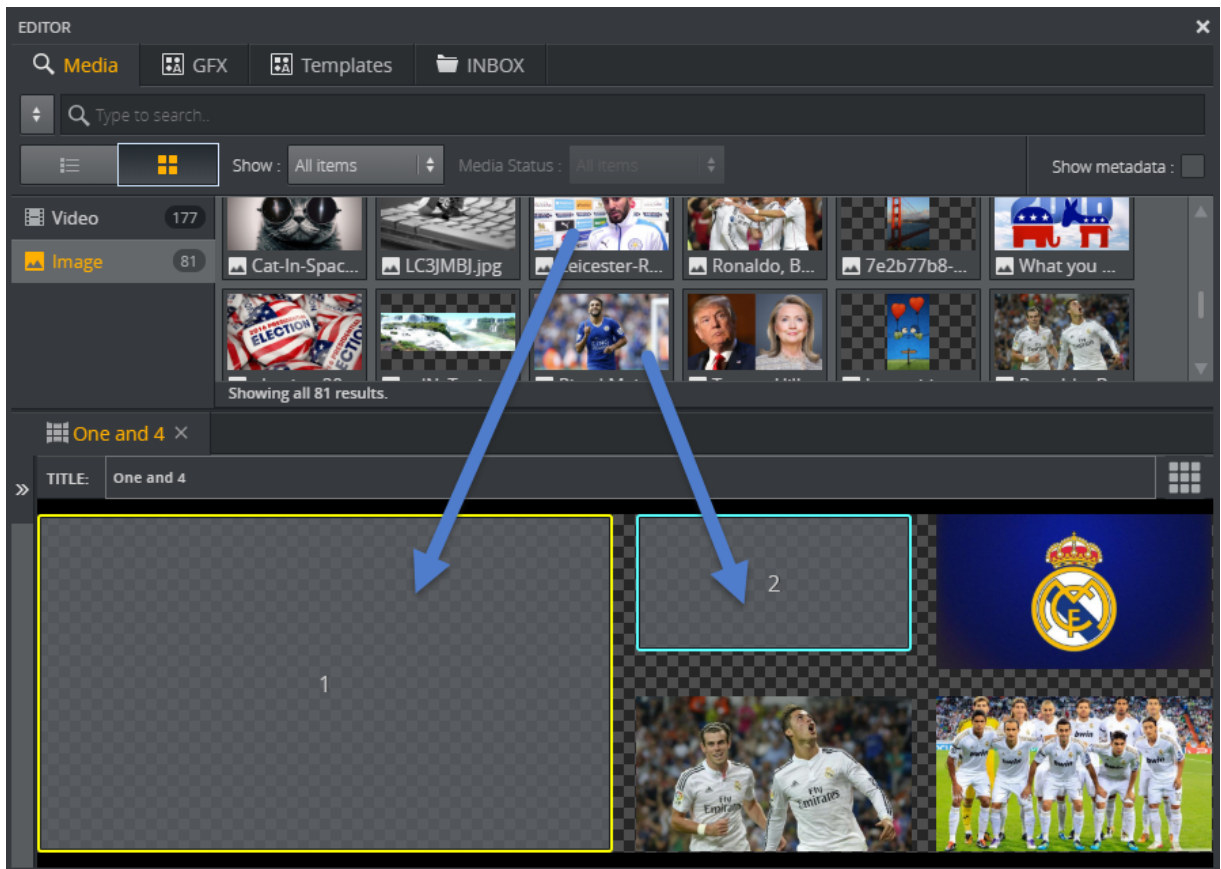

5. Edit individual elements in a video wall by clicking the **play icon**, or by right-clicking and selecting **Edit** or simply double-clicking content in a GFX area.

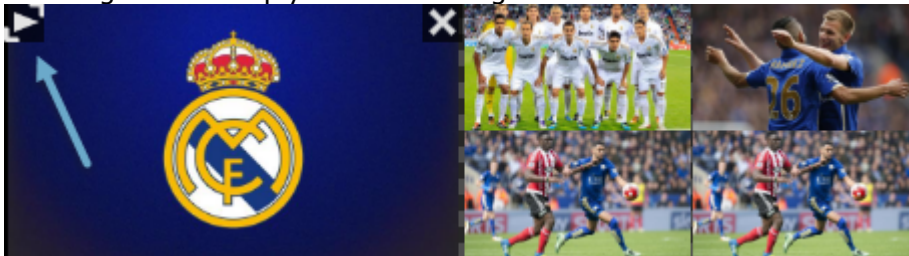

6. A GFX area may occasionally be outside the editor, or two GFX channels might partly or fully overlap. If this happens, hold **SHIFT** down to reveal the GFX channel numbers behind the content and click **Reveal** to show a secondary view where all the GFX channels are stacked out:

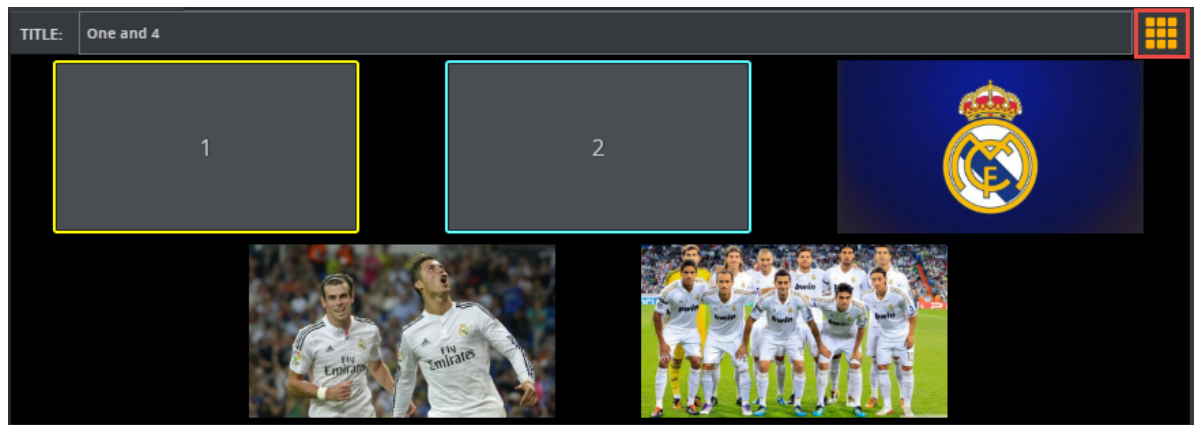

7. Once the video wall preset is filled (partly or completely) with elements you can close the editor.
8. The preset thumbnails in the **Walls** group in the shortcuts playlist now reflect the content put into the video wall preset.

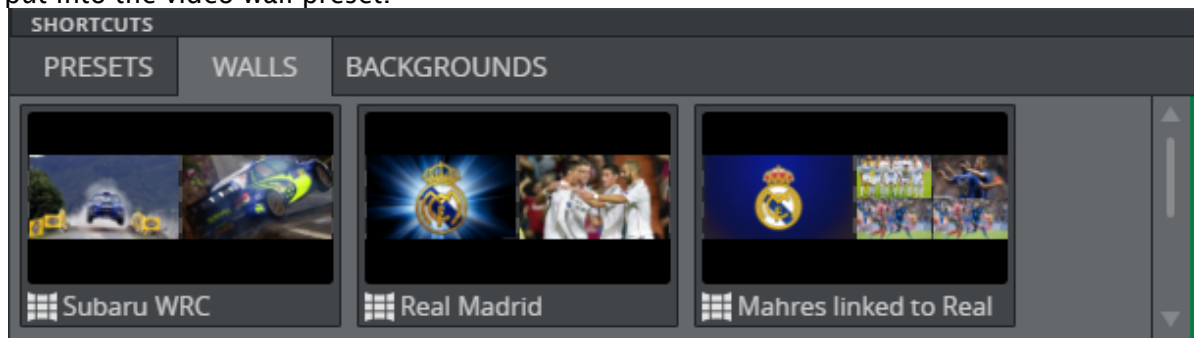

- ✓ **Tip:** It's possible to fill one or more GFX channels in a filled preset. The existing content of the non-filled GFX channels that are on air will then remain on air when a partly-filled preset is played out.

### 3.7.4 Adapt the GUI for Pre-filled Walls

A nice workflow is to create a workspace where you hide all GFX channels and only show the main channel. Remove the shortcuts playlist and increase the thumbnail size to 200. You can then drag presets from the Videowall tab over to the A channel and fill them with content. You then have a GUI where the operator can control full walls with a single tap:

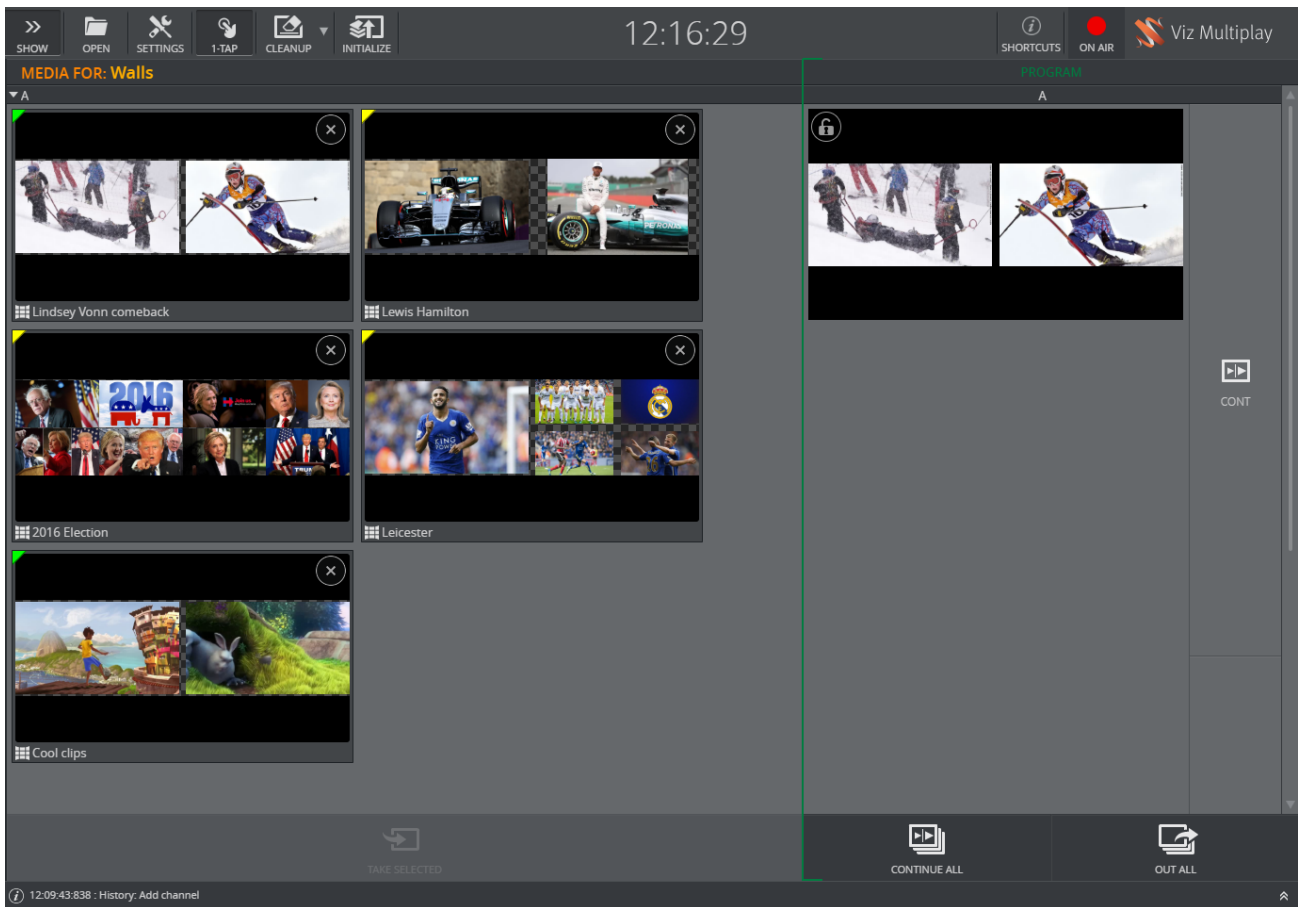

Only the main channel is visible in this workspace, and the thumbnails have a maximum size. With one click or tap, the Viz Multiplay operator can now toggle complete walls with layout and content.

### 3.7.5 The Preset Content Editor

The Preset Content Editor is an editor for filling video wall [Presets](#) with predefined content, which are then referred to as [Filled Presets](#).



In the editor, search for content (videos, graphics, images) and drag it into a preset. Depending on your configuration, content is contained in various tabs, including the Templates, GFX and Media tabs etc. When the filled preset is ready, drag it either into the group for the main channel of the video wall, or to the shortcuts bar in the show.

1. Right-click a preset in the [Using Shortcuts](#) or in the main channel of the video wall.

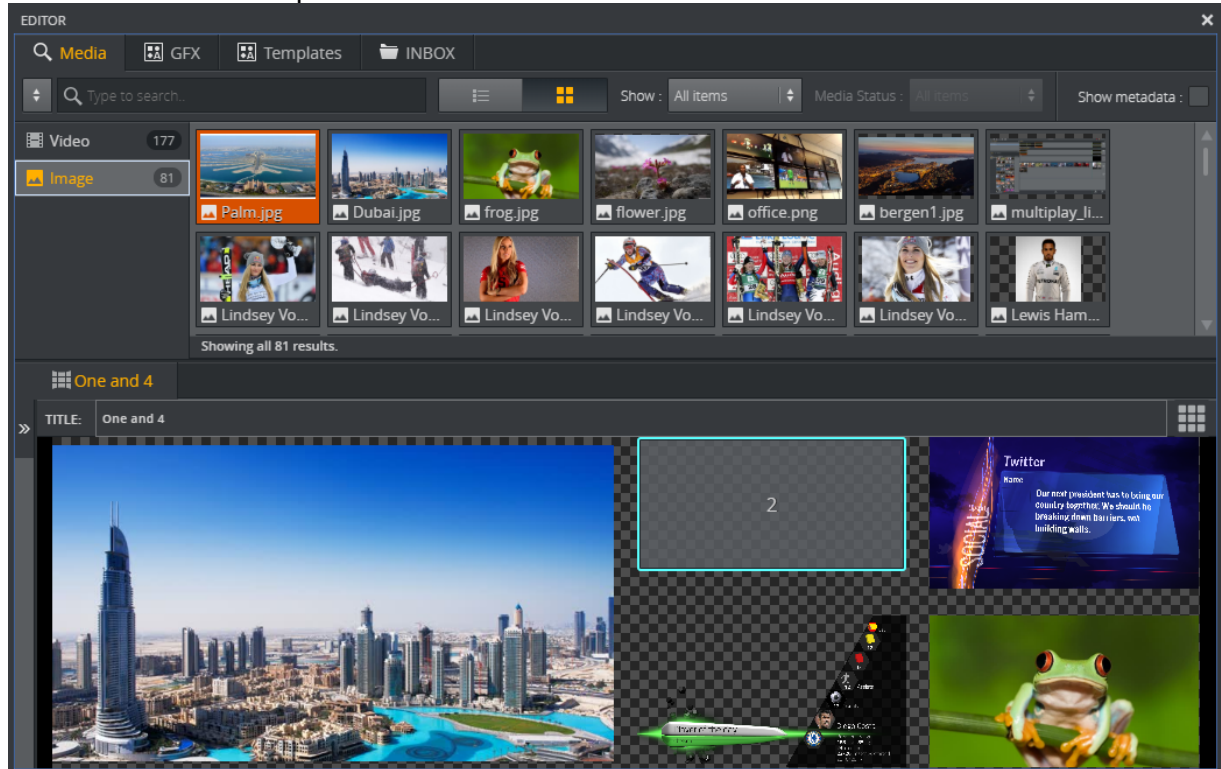
## 2. Click **Edit Content** to open the Preset Content Editor:



In this editor, you can create a video wall layout with content filled into the GFX areas:

- From the top tab bar, select a source for the content. This can be Media assets, graphics or content from an inbox.
- Drag selected content into the GFX areas.
- Click the Play button  on the thumbnails to edit, or alternatively double-click content or right-click and select **Edit**.
- Click the View Mode button  to switch between actual video wall layout and all GFX channels visible.

## 3.8 Working With Viz Pilot And MOS Content

This section covers integrating Viz Multiplay with Viz Pilot and MOS playlists. In addition, it deals with setting up a Pilot Data Server directly in Viz Multiplay.

The following topics are presented here:

- [Viz Pilot Playlists](#)
- [The MOS Workflow](#)
- [Pilot Data Server](#)

### 3.8.1 Definitions

- **Internal playlists (show playlists):** These playlists are owned by the show, exported together with the show, and deleted when removed from the show. Viz Multiplay automatically creates three internal playlists when creating a new show: Shortcuts (for often used presets), GFX (for source graphics) and Videowall (for source presets that can be dragged into the show or into shortcuts).
- **External playlists:** These playlists are created by an external system such as Viz Pilot or a MOS playlist from a newsroom system. External playlists are not owned by the show and are only referred to from the show. External playlists have the same appearance as internal playlists, but will not be deleted when removed from the show.

### 3.8.2 To Add a Playlist

- Click the **Add (+)** button to the right of the tabs in the Show pane. You can now choose between adding an internal or external playlist.

### 3.8.3 Viz Pilot Playlists

If you have already set up your Media Sequencer in a Viz Pilot workflow then you have likely also created one or more Viz Pilot playlists.

These can be added as external playlists to your show:

1. Click the **Add (+)** button to the right of the tabs in the Show pane.
2. Click **Add external playlist**.
3. Browse to the playlist you want to add and click **OK**.

 **Tip:** Organize elements in shows and playlists in groups to ensure that they appear in Viz Multiplay.

 **Note:** You cannot edit elements in this Viz Pilot playlists if Media Sequencer is set up with an Oracle connection to the Viz Pilot database. You must then use Viz Pilot to edit the elements.

### Edit the Elements in a Viz Pilot Playlist

Right-click an element and select **Edit** if the Media Sequencer is set up to connect to a Pilot Data Server (which can be backed by either an Oracle database or a Viz Graphic Hub). The elements are then put back to the database through an HTTP connection to the Pilot Data Server. The Media Sequencer will detect this change and update the element in the Media Sequencer automatically.

### 3.8.4 The MOS Workflow

The Media Sequencer contains one or more MOS playlists if it's set up in a Newsroom workflow connected to a Viz Gateway. The Media Sequencer is responsible for communicating with the

Newsroom system through the MOS protocol and keeping the MOS playlists up to date. Any changes are immediately reflected in Viz Multiplay.

MOS playlists can be added as external playlists to your show:

1. Click the **Add (+)** button to the right of the tabs in the Show pane.
2. Select **Add external playlist**.
3. Browse to the MOS playlist you want to add and click **OK**. Initially, the MOS playlist is empty. To request it from Viz Gateway, right-click the MOS status label and select **Request**.

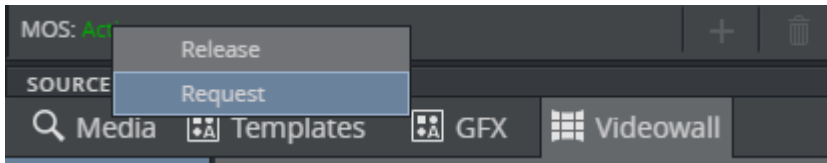

The Media Sequencer now takes ownership of the MOS playlist and updates it live whenever the rundown changes.

Since MOS playlists are organized in stories (groups), the elements will be visible in Viz Multiplay. Each story becomes one group in Viz Multiplay. Clicking the group will expose the elements in the group, organized per channel. Elements in a MOS playlist are owned by the newsroom system, and can therefore not be edited. However, it is possible to drag elements from one channel to another channel.

## Assigning a Channel

In Avid iNEWS, you can specify the playout channel by right-clicking the item in the story and selecting **Assign Channel**.

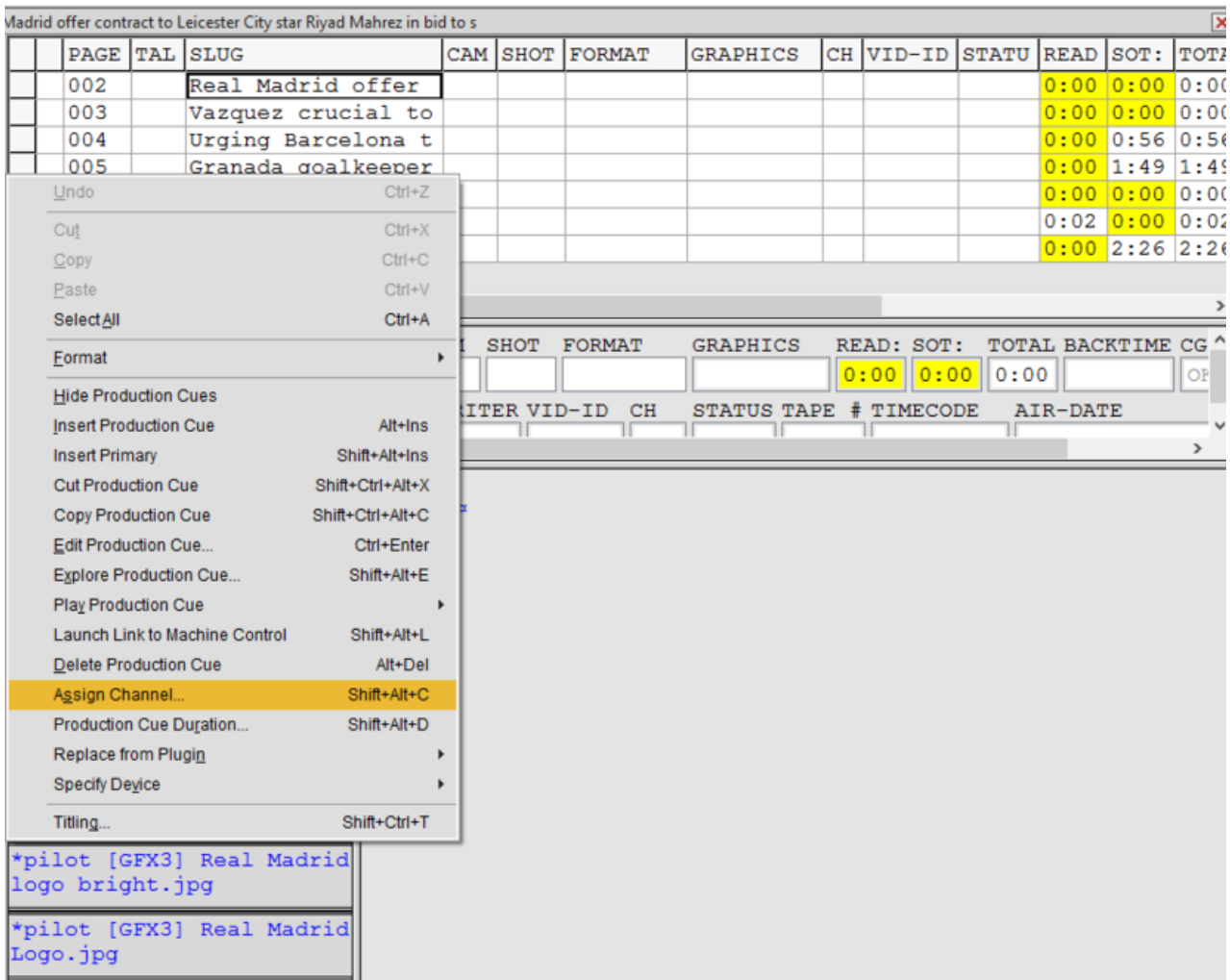

When Media Sequencer receives the MOS playlist, it sets the channel on the elements so Viz Multiplay can organize them under the correct channel in the GUI. This channel must exist in the active profile. Elements without a channel will appear under the channel set as the Program channel.

### Write Channel to Newsroom System

If you drag a MOS element in Viz Multiplay to another channel, it's possible to write the new channel back to the newsroom system. This feature must be enabled in Viz Trio:

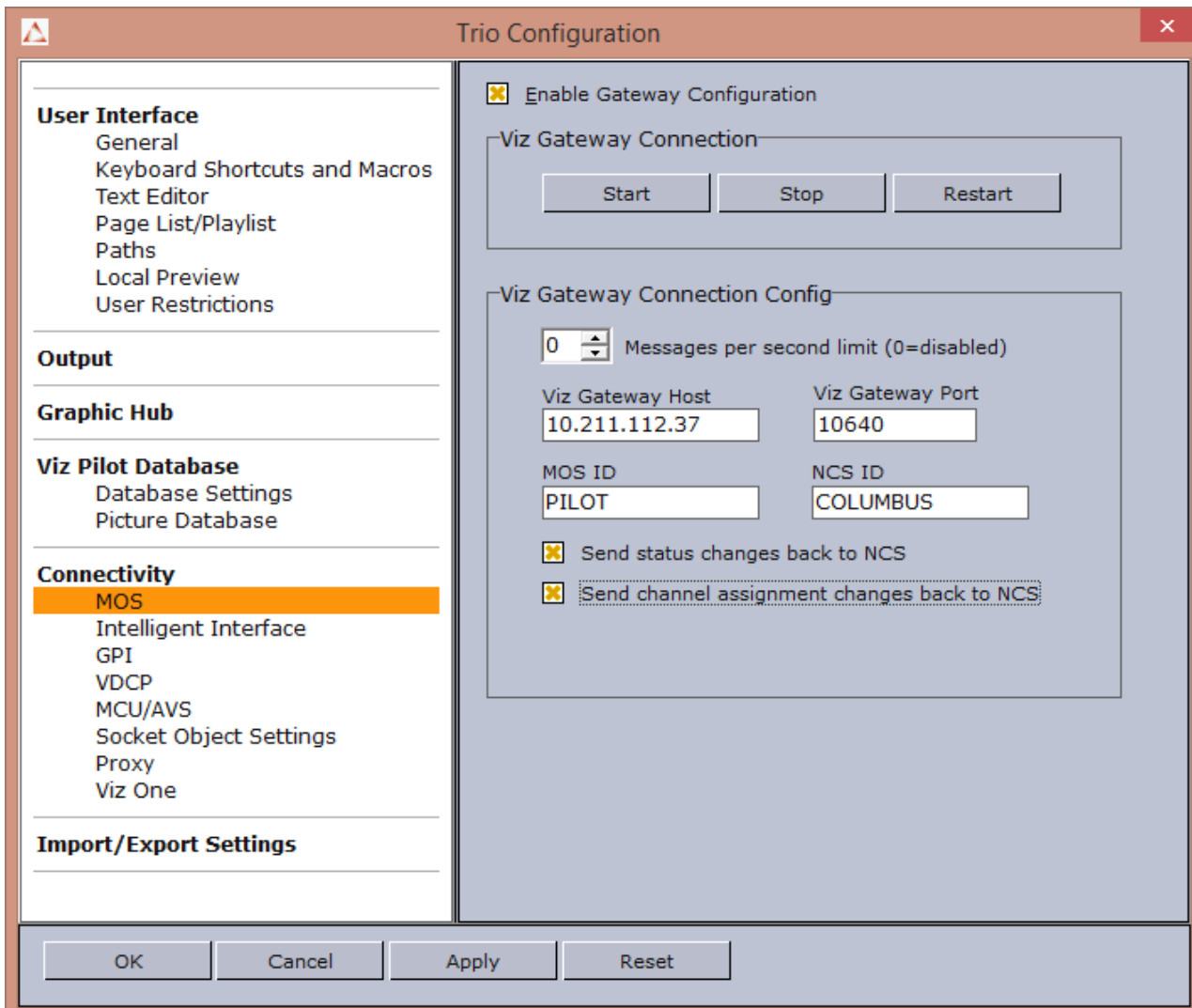

You can release the MOS playlist from the Media Sequencer by right-clicking the MOS status bar and selecting **Release**.

**Caution:** The Media Sequencer will stop updating the playlist for all clients connected to the Media Sequencer. Exercise caution when releasing a MOS playlist.

### 3.8.5 Pilot Data Server

If it's installed on your system, Viz Multiplay can connect to a Pilot Data Server and use the graphics directly without using an external Viz Pilot playlist.

To set up this workflow, both Viz Multiplay and Media Sequencer must be configured to use the same Pilot Data Server.



## Configure Pilot Data Server in Viz Multiplay

1. Go to **Settings > Servers**.
2. Enter the URL or hostname to the Pilot Data Server in the Pilot Data Server input field.

✓ **Tip:** Enter only the host name and press **TAB** - Viz Multiplay auto completes the full URL.

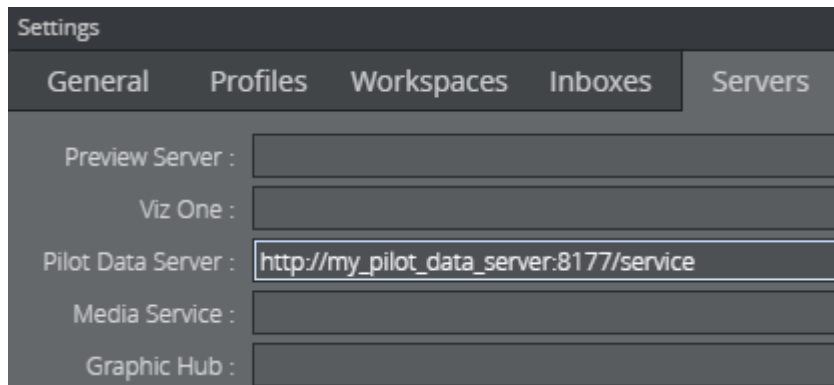

3. The **Templates** tab appears in the Sources pane once Viz Multiplay connects to the Pilot Data Server:

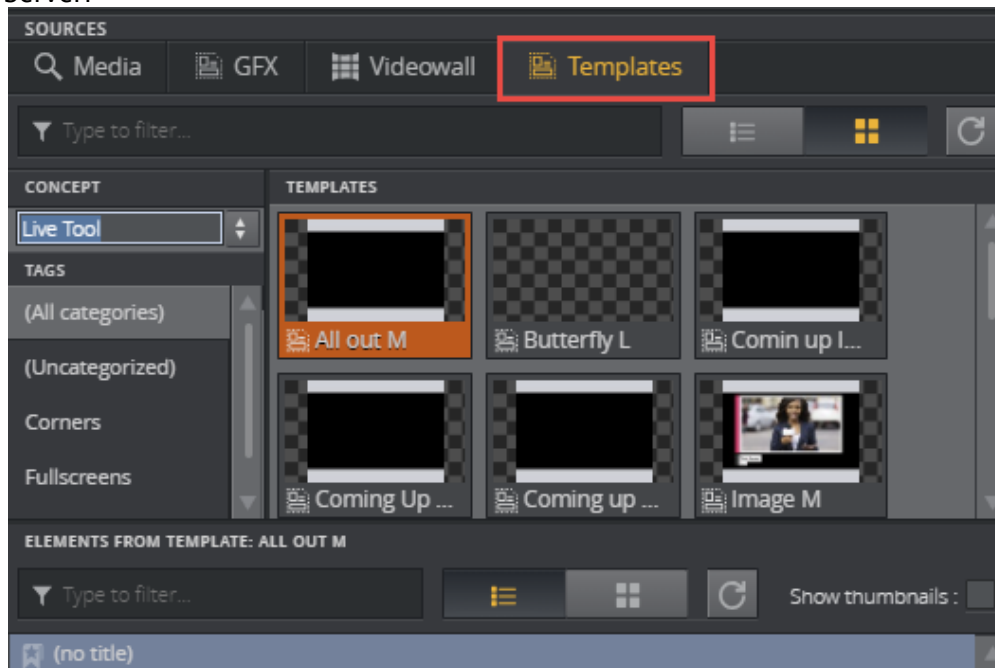

✓ **Tip:** If the **Templates** tab does not appear after configuring the Pilot Data Server URL this likely indicates that the URL is unreachable. Type the URL in a browser to see if you can connect to a Pilot Data Server.

The Templates tab contains Viz Pilot concepts and templates. Drag a template over to the playlist area. Viz Multiplay will now create a new Viz Pilot database element and insert a reference to it in Media Sequencer. Media Sequencer is responsible for connecting to the Viz Pilot database and inserting the element into Media Sequencer so it can be played out. Media Sequencer also keeps the element up to date whenever a change is made to the database element.

## Connect Pilot Data Server to Media Sequencer

1. In a browser, go to `http://mse_host:8580/app/pilotdbconfig/pilotdbconfig.html`.
2. Add the host and port to the Pilot Data Server in the config GUI.

**Note:** You may need to restart Media Sequencer.

When you edit the Viz Pilot elements in Viz Multiplay (right click and select **Edit**), the changes are sent directly to the Viz Pilot database through HTTP. Media Sequencer detects any changes and updates the element in Media Sequencer automatically.

## 3.9 Using A Switcher

This section covers using a switcher to control elements in the Media Sequencer. The switcher must support the PBus protocol.

A switcher provides an alternative to using the user interface to perform an action such as Take or Out on an element.

**Note:** The various actions that can be performed on elements are described [here](#).

### 3.9.1 Background

The Peripheral Bus (PBus) protocol enables controlling the Media Sequencer from a switcher using a serial interface and a few simple commands. The hardware hookup is a serial line running from the switcher to the Media Sequencer machine. Since PBus is a one-way protocol, data flows only from the switcher to the Media Sequencer. The Media Sequencer supports three commands: Recall, Learn and Trigger.

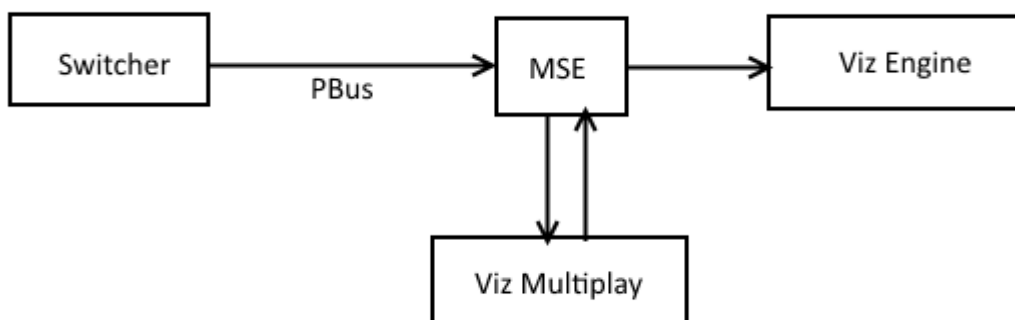

The workflow is as follows:

- The switcher sends a **Learn** command with an ID to the Media Sequencer. This means that the Media Sequencer now is ready to connect this ID to an element.
- The Multiplay operator selects an element (a preset, a video, graphics, image etc.).
- The Media Sequencer has now connected the ID to an element.
- The switcher later sends a **Recall** command with an ID to the Media Sequencer. Now the Media Sequencer is ready to perform an action on this element.
- The switcher sends a **Trigger** command with a number representing an action. The Media Sequencer performs this action on the recalled element.

### 3.9.2 Configuring the Media Sequencer

From the **Settings > General** tab in Viz Multiplay, click the **PBus Switcher Config** button. A new browser window opens with the configuration application.

The screenshot shows the 'Config' tab of the PBus Switcher Config application. It features a dark grey background with white text and controls. At the top, there are three tabs: 'Config' (highlighted in orange), 'Recalls', and 'Actions'. Below the tabs, there is a checked checkbox labeled 'Enabled'. A note below the checkbox reads: 'Note : For changes to take effect, you might need to Disable and Re-Enable the PBus handler'. The configuration fields are: Port: COM4, Device: 0, Baudrate: 38400, Stopbits: 1, Databits: 5, Parity: Odd, and Flowcontrol: None.

Consult the manual for the switcher to find the settings that enable communication between the switcher and MSE. The Device number must match the device number of which the switcher sends commands to, because the switcher can be connected to multiple devices. Commands can thus be sent from the switcher to one or multiple devices, by specifying the device number when sending the command.

There is no established connection between the switcher and the Media Sequencer, so it is not possible to test whether the connection is up or lost. The best way to test the connection is to send a Learn command from the switcher and monitor the result in Viz Multiplay. If a successful Learn command is sent from the switcher, a panel appears in Viz Multiplay. The following section explores this in more detail.

**Note:** You may need to disable and enable the PBus settings to make them take effect in the Media Sequencer. Click the Enabled checkbox twice.

### 3.9.3 Learning Elements

A learn panel replaces the clock when the switcher successfully sends a Learn command to the Media Sequencer. This happens for all Viz Multiplay clients connected to the Media Sequencer.

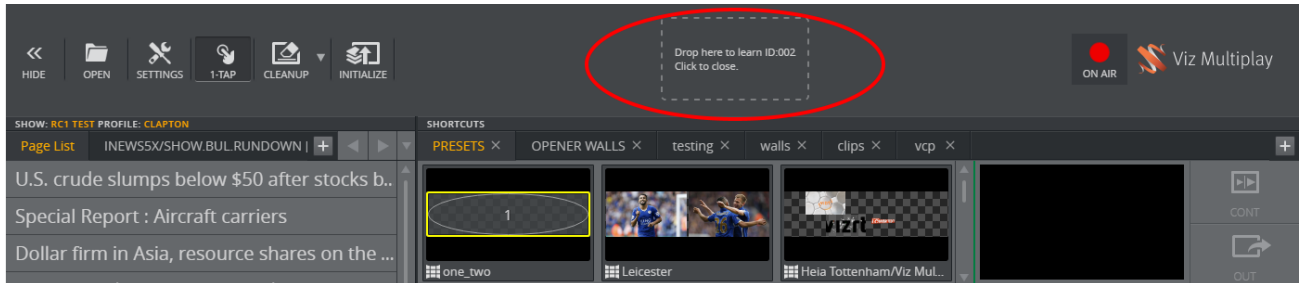

Drag any element from the Viz Multiplay GUI onto the learn panel. The panel then disappears. When this operation is done - the dropped element is connected to the ID given from the switcher. This completes the "learn" operation. The dropped element is now "learned" by the switcher, and can later be recalled with the given ID.

Verify and monitor learned elements by opening the PBus Config application.

1. Click the **PBus Switcher Config** button in the **Settings > General** tab in Viz Multiplay.

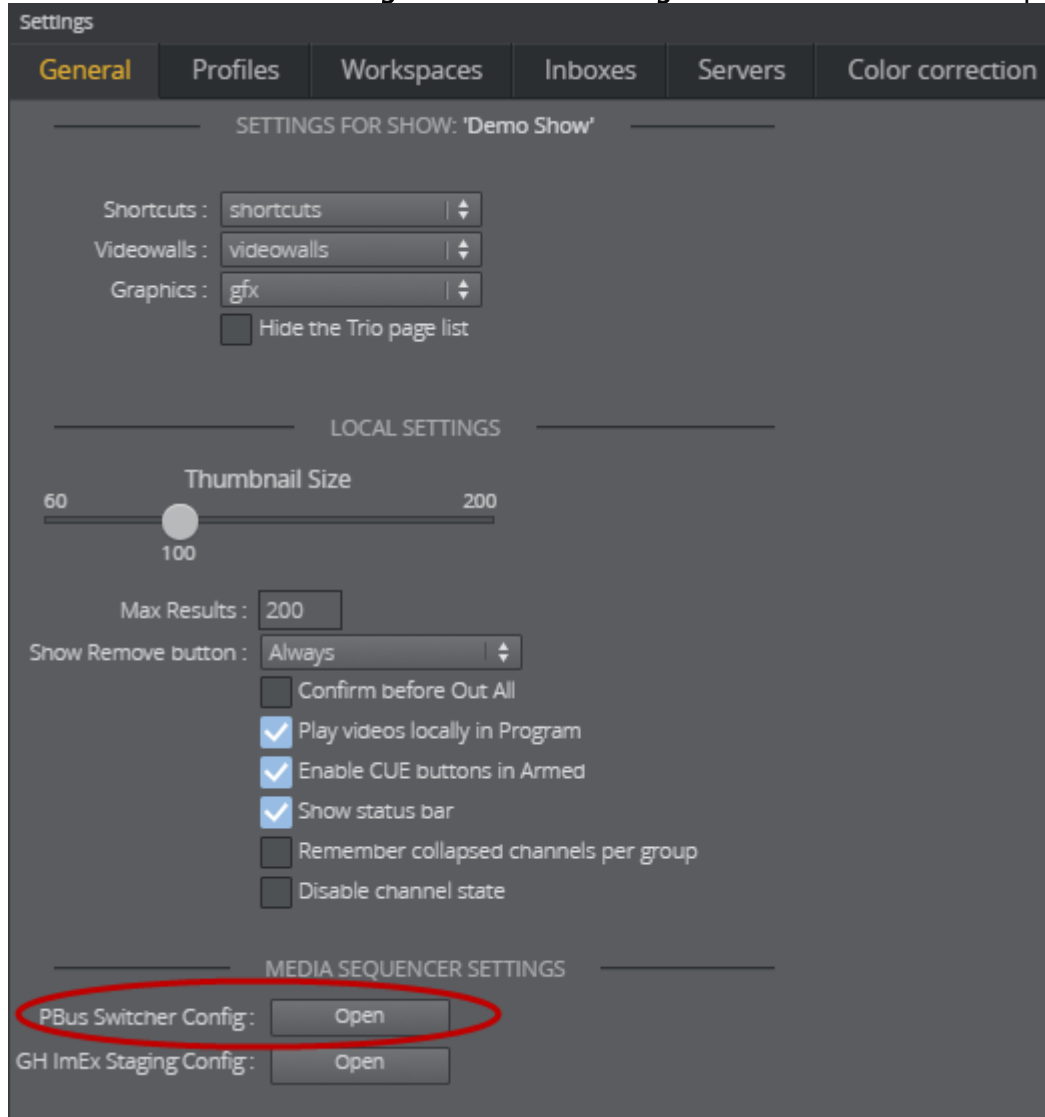

- Click the **Recalls** tab, which contains a list of all the elements learned by the switcher.

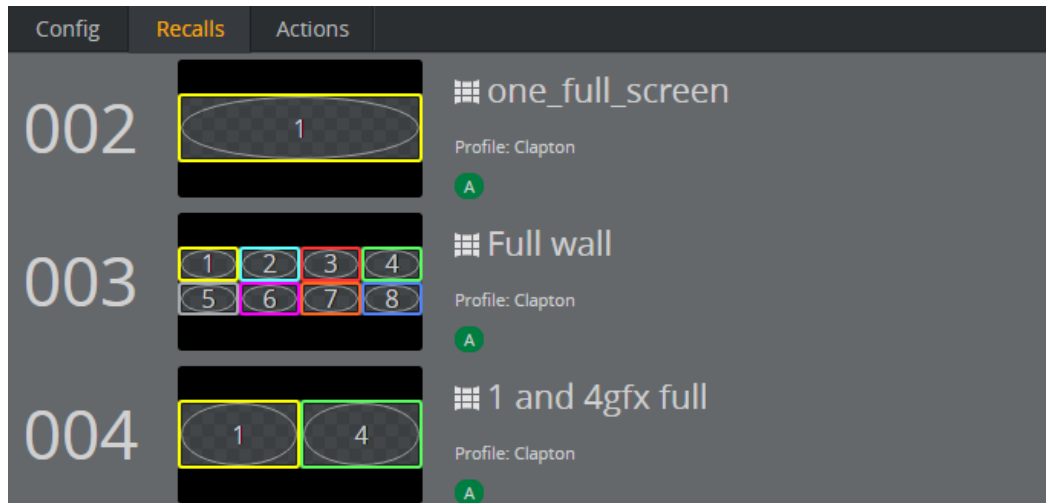

**Note:** Click the cross to the right in the window to remove a learned element from the list.

### 3.9.4 Recalling and Trigger

When the switcher wants to control a learned element, it sends a Recall command with an ID. The PBus Config then marks the recalled element.

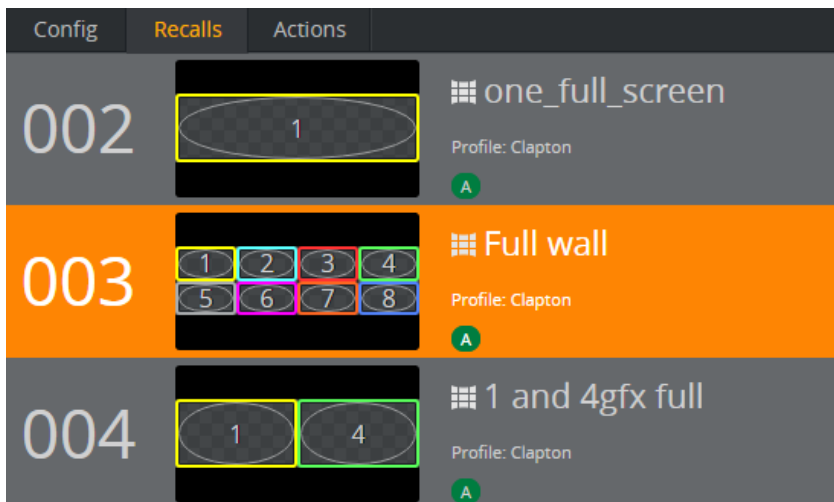

Now the recalled element is ready to receive actions. The switcher then sends a Trigger command with a number representing the action it wants to perform. The actions and their associated numbers defined default by the MSE are listed in the **Actions** tab.

Config	Recalls	Actions
ID	Action	
1	Take	
2	Continue	
3	Out	
4	Cue	
5	Pause	

✓ **Tip:** Configure switcher actions differently by editing the number associated with an action. For instance, the switcher sends a Trigger command with ID 0 to take an element on air, click the ID to the left of Take and change it to 0.

## 3.10 Using Graphic Hub Image Staging

This section covers using the Viz GH ImEx Agent, a Graphic Hub staging mechanism that automatically transfers images from URL resources to Graphic Hub.

The agent downloads and prepares the URL resources with the suitable compression level before transferring them to Graphic Hub. This means they use minimal resources on the renderer when taken to air, playing out without any framedrop.

This section covers:

- [Required Components](#)
- [Configuration and Setup](#)
- [Workflow in Viz Multiplay](#)

### 3.10.1 Required Components

The workflow requires:

- Viz Graphic Hub
- Viz Graphic Hub REST service
- Media Sequencer version 5.0 or higher
- The [Viz GH ImEx Agent](#)

### 3.10.2 Configuration and Setup

Install and configure Graphic Hub ImEx over three steps by installing the ImEx Agent, creating an image staging folder and setting a publishing point.

ⓘ **Info:** This procedure requires the following components to be installed: Media Sequencer 5.0 or higher, the Graphic Hub and the Viz Graphic Hub REST service.

## Install

- Install the [Viz GH ImEx Agent](#).

## Create Image Staging Folder

Create a folder in the Graphic Hub where images should be staged to. See the Servers and Folders section in the *Graphic Hub Administrator Guide* for how to create a folder.

## Set Publishing Point

Use the Viz GH ImEx Agent to set up a publishing point to the folder through the GH REST service.

1. Enter the URL to the Viz GH ImEx Agent, then click **Options** and **GH REST Hosts**.

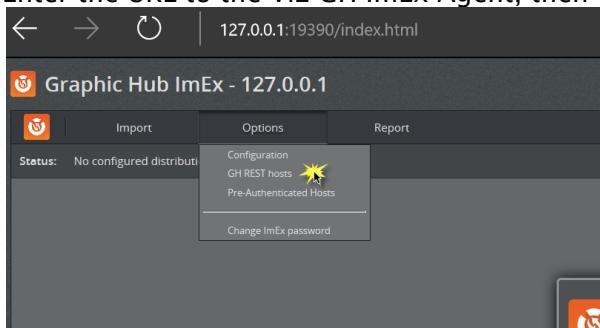

2. Click **Add GH REST Host**.
3. Select a server or enter the service document from a GH REST AGENT manually.

### 3.10.3 Workflow in Viz Multiplay

Enable media transfers via the ImEx Agent using the Viz Multiplay interface.

1. Click **Settings > General**, then click the **GH ImEx staging config** button.



- The configuration application opens in a new tab in the browser:

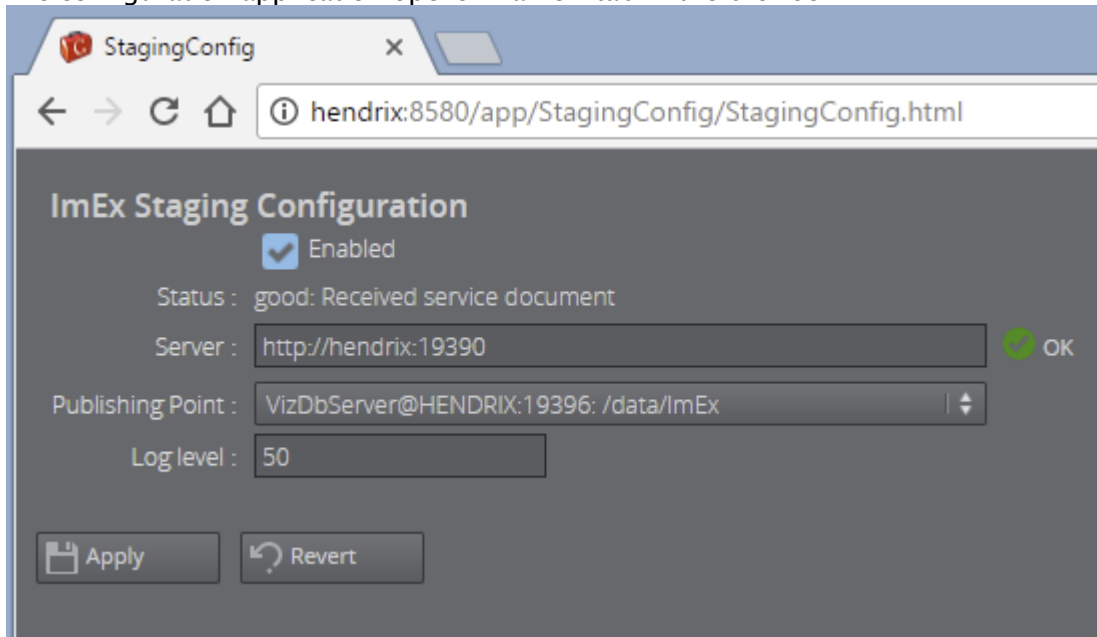

**Info:** The **Server** field contains the URL to the Viz GH ImEx Agent. This service is usually found on port 19390 on the host where it is installed.

- If the connection is good, the **Publishing Point** dropdown is populated with possible Graphic Hub backends, where the images will be transferred.
- After activating a show profile, the Media Sequencer monitors images in the show and transfers from the URL source to the publishing point.
- During the publishing operation, the progress is shown on the image, as shown here:

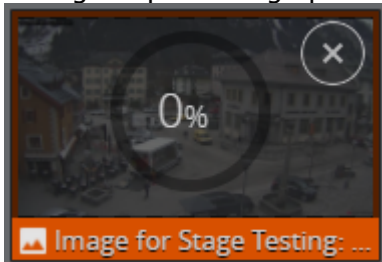

When the image is ready, the progress disappears:



**i** **Info:** Set the **Log level** to a value between 0 and 100 to adjust the amount of log messages from the Image Staging handler on the Media Sequencer. A higher level generates more log messages. This can be useful when inspecting the system during debugging. The log messages appear in the Media Sequencer log.

The **Revert** button undoes any local changes in the config window. It does not reset anything on the Media Sequencer.

The **Apply** button applies the current settings to the Media Sequencer.

---

## 3.11 Tips And Tricks

- [Filling Clips/Images in GFX Channels instead of Letterboxing](#)
- [Enabling Transitions between Video Clips](#)
- [Tips and Tricks for Viz Engine 3.8.2 or Later](#)
- [Tips and Tricks for NVIDIA Mosaic](#)
- [Performance Issues](#)

### 3.11.1 Filling Clips/Images in GFX Channels instead of Letterboxing

In GFX channels, the `StillAndVideo` scene letterboxes clips and images. If for instance a 16:9 clip or image is played out in a portrait GFX channel, the content is not cut off, but placed inside the portrait area to fill the width but not the height. The GFX channel will be blank over and under the content. If you want to fill the whole GFX area always - scale up the content and cut it off - this can currently be done by manipulating the `StillAndVideoScene` like this:

Do one change in these four scripts:

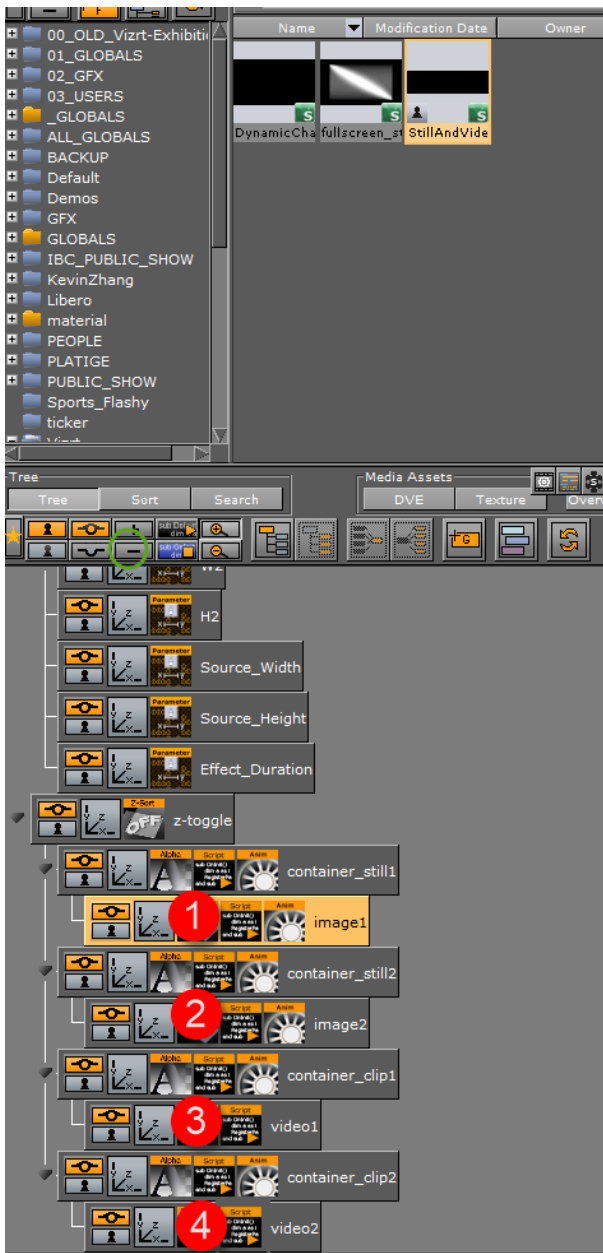

The script lines are:

- if render\_aspect>(my\_aspect\*kb\_aspect) then .... for image1 and image2
- if render\_aspect>(image\_aspect) then .... for video1 and video2

In these four script lines, change > (greater than) to < (less than). Click Compile and run for each script you open. Save the scene. Cleanup the renderer and take a preset again. Now the letterboxing should be changed to a fill.

### 3.11.2 Enabling Transitions between Video Clips

The Viz Engine has 16 GFX channels and 16 video clip channels. In Viz Multiplay one clip channel is used per GFX channel. This means that 16 clips can be played simultaneously in 16 different

GFX channels. Though, if fading between clips should be enabled, each GFX channel then needs two clip channels to perform the fading. This means that for each GFX channel that should have transition enabled, the number of GFX channels should be reduced by 1.

**Example 1: 2 GFX channels with transitions enabled.** In this scenario, clips with transitions should always be played in two special GFX channels - for instance, GFX1 and GFX2. These two GFX channels then need two extra clip channels to perform the fade. Using clip channels 15 and 16 for this - will then effectively mean that the video wall setup will only have 14 GFX channels available.

**Example 2: 8 GFX channels with transitions enabled.** In this scenario - all available GFX channels will have the possibility to play transitions between clips. This reduces the number of GFX channels to 8. GFX1 may use clip channel 9 for the transitions, GFX2 may use clip channel 10 and so one.

## Setting Up Clip Transitions

- In Viz Artist, open the Vizrt\DynamicChannels scene.
- Go to **Media Assets > Texture** and add (drag in) as many extra clip channels as needed (8 is added by default):

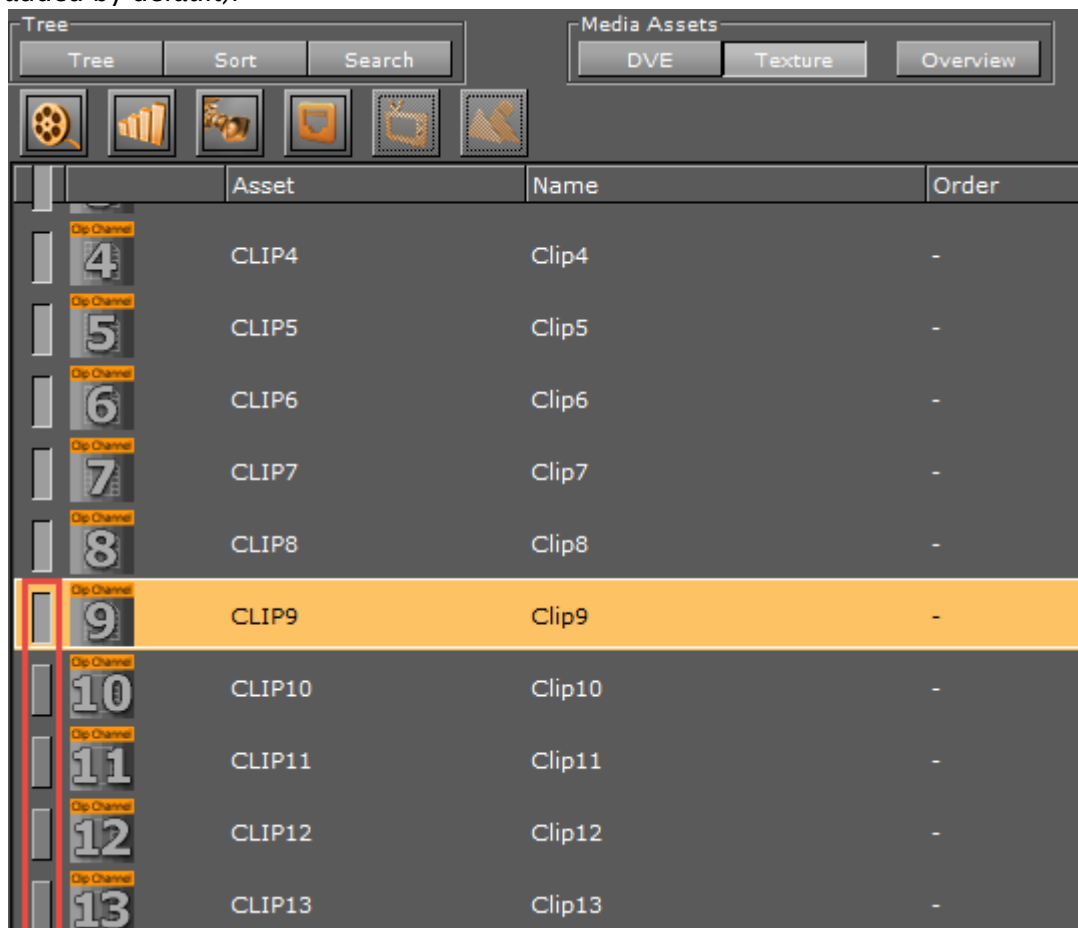

- If more than eight GFX channels are needed, go to **Media Assets > DVE** and enable as many GFX channels as needed.
- In Multiplay, go to **Settings > Profile Config**.

- Click the profile for the video wall and expand the GFX channels that should have clip transitions.
- Double-click the video handler under each GFX channel:

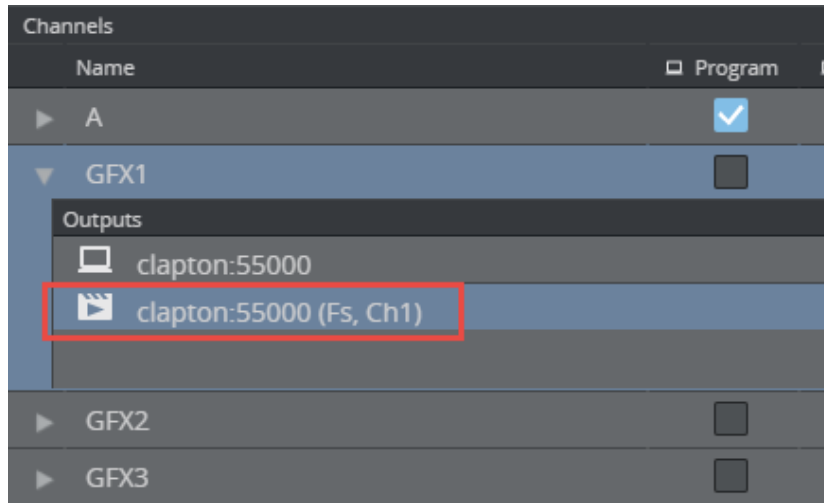

- Check **Use Transitions** and enter the alternate clip channel number to use. Usually, each GFX channel uses the corresponding clip channel number, but now, the clip channel number entered in **Alternate Clip Channel** will prevent the corresponding GFX channel to be used. In the example below, clip channel 9 is used for the fade, which means that GFX 9 is unavailable for clips.

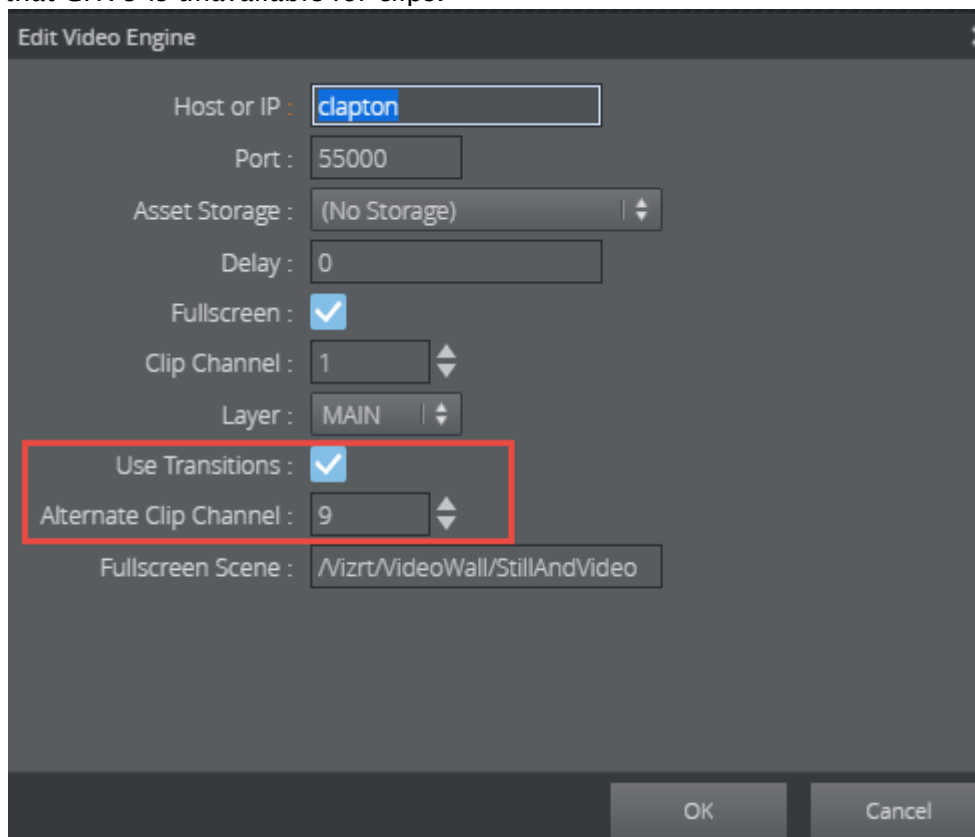

### 3.11.3 Tips and Tricks for Viz Engine 3.8.2 or Later

Make sure you read and follow the recommendations in the *Video Wall Configuration* section of the [Viz Engine Administrator Guide](#).

- To get better performance, start viz.exe with parameter -w. In addition, set the setting create\_default\_renderer = 1 in the config file.
- To see commands: “send MAIN SHOW\_COMMANDS ON”.
- If more than one GPU is used, and video clips and transitions flicker, send the command “RENDERER JOIN\_SWAPGROUP 1”.
- Remember that playing clips requires that all that frame rates and refresh rates match the videos - both in Clip in formats, renderer format and on the actual physical screens.
- To see performance, send the command “RENDERER SET\_PERFORMANCE 1”.

### 3.11.4 Tips and Tricks for NVIDIA Mosaic

#### Common Requirements

- All monitors connected to the GPU must be identical models and running at identical resolutions/refresh rates. You can not have a different resolution/model 'control' monitor connected to the system without introducing tearing in at least one of the displays.
- If possible, the monitors should be combined into a single large virtual monitor using Nvidia's Mosaic.
- Only have one window rendering. If you are outputting to multiple monitors use a single large window that covers your entire desktop, not one window per monitor.

#### Quadros

- When setting up Mosaic, be sure to not move monitors around using this dialog. Due to a driver bug this will disable the Preset you are trying to use in the next step. If your monitors are connected in reverse, change the connections manually.
- In the Nvidia Control Panel, go to the **Manage 3D settings** page and select **Video Editing** as the profile/preset to be used.
- Ensure the Windows taskbar is not on top of your display window. We have tested our system with an external blackburst sync signal, if you try to use anything else than NTSC or PAL as sync format the screen will start to flicker.

For normal 50 Hz European format use PAL.

### 3.11.5 Performance Issues

This section covers the following topics:

- Dynamic Channel scene
- Video wall setup
- Background loading of images (performance)

## Dynamic Channel Scene

The Dynamic Channel scene must be seen as a template. It should not be used in the distributed version. It must be modified by a Viz Artist expert on location to match the customer system. This improves performance significantly:

- In Dynamic Channel, disable or preferably remove all GFX channels not in use. (The default Dynamic Channels scene has 16 GFX channels, of which eight are disabled.)

### In addition, during the playout situation:

Before going On Air, "warm up" (take) all the scenes that are going to be taken. Initializing is often not enough. Scenes should be taken On Air and out again at least once on their GFX channel. The next time they are taken, Viz Engine displays them without affecting the overall performance.

Always take a preset On Air before the show starts. Never take presets out. There should always be a preset On Air.

## Video Wall Setup

Configuring a video wall setup is not straight forward. Make sure you read and follow [this advice](#).

 **Tip:** There are many factors impacting the performance of a video wall driven by one Viz Engine, so try experimenting and fine tune the setup with real content and real constraints.

## Background Loading of Images (Performance)

Support for background loading of images was added in Multiplay 2.2.

 **Note:** This is unrelated to the general config setting enabling background loading in Viz Config.

This fixes a bug that froze the video wall for notable periods. This arose when a fullscreen image was added to a show and taken to air without initializing it first. While downloading the image, the Viz Engine would then block the renderer and render the image, causing the wall to freeze.

## Requirements

- Background loading of images requires the latest official Viz 3.8.3.62368 build (or later) on the official [FTP](#).
- The #13 version (the scene version bundled with Multiplay 2.2) of the DynamicChannels scene must be present in Graphic Hub.

 **Note:** Images from an HTTP resource (Viz One and Media Service) can still cause a small frame drop in the renderer, but at least the renderer will download it in the background and not block for a long period.

## Preparing Images in GH

Images from Graphic Hub should not cause any frame drop in the renderer if they are background-loading compatible. This means they should be DXT1 or DXT5 compressed images.

To check whether a GH image is background loading compatible:

1. Open Viz Artist, locate it in the server tree.
2. Right-click the image and choose **Check for Background Loading**.

To make a GH image background loading compatible:

1. Open Viz Artist, locate it in the server tree.
  2. Open the image by double-clicking it.
  3. Choose **Convert Format** in the left menu.
  4. Choose **DXT1** or **DXT5** in the menu that appears.
  5. Save it.
- 

## 3.12 Editing Graphics, Videos And Images

Once items have been added to the [Media Column](#) in a story, they can be edited (right-click the item and select **Edit**).

The editing options depend on the type of media:

- [Editing Images](#)
- [Editing Videos](#)
- [Editing Graphics](#)
- [Editing Presets](#)
- [Renaming Playlist Entries](#)

### 3.12.1 Editing Images

Use the Image Effect Editor to crop an image or add a zoom/pan animation.

#### Image Effect Editor

To open the editor, right-click an image and select **Edit**.



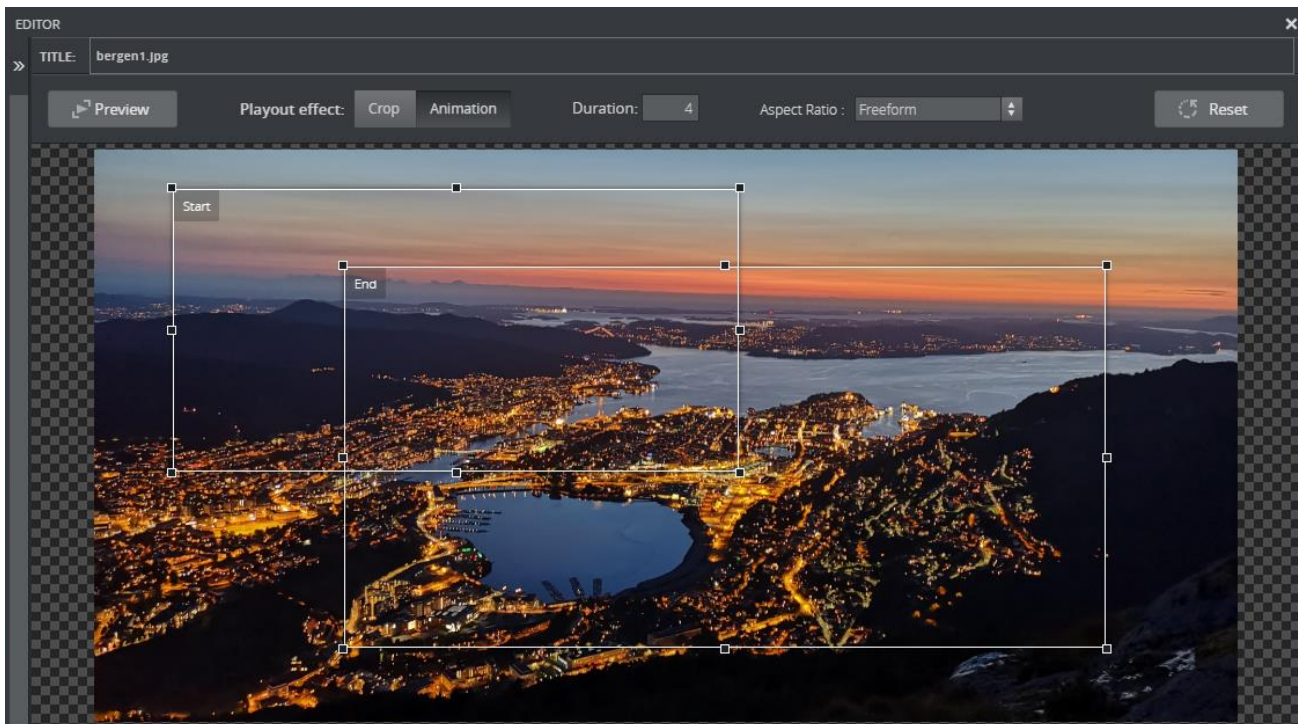

The Image Effect Editor allows you to crop or animate an image instantly using a crop rectangle. By default, the crop rectangle matches the image's aspect ratio, but you can also freely set the rectangles' aspect ratio.

- To **animate** an image, select a start and end frame and a duration for the animation. Preview the animation using the **Play/Stop** button.
- To **crop** an image, drag the rectangle to the desired size.

✔ **Tip:** Hold **CTRL** before dragging the crop rectangle to maintain the current aspect ratio.

⚠ **Note:**

- All changes are live and cannot be canceled.
  - The image editor is only available for images in GFX channels.
  - The image editor uses a proxy image, so the image may differ slightly when played out on a Viz Engine.
- To force a different aspect ratio of the rectangles, select a value from the **Aspect Ratio** list. The values in brackets are:
    - **Freeform:** Freely set the aspect of the rectangles.
    - **Image:** Aspect is locked to the aspect of the image.
    - **GFX Channel:** For filled presets - the aspect is locked to the aspect of the GFX channel the image is assigned to.
    - **Profile Channel:** Locks the aspect to the aspect set on the channel in the profile configuration.

- Click the **Reset** button to reset applied effects to the default settings.

### 3.12.2 Editing Videos

Use the Video Editor to edit videos.



#### Open the Video Editor

1. Right-click a video in a channel in the Media Column or in the Shortcuts Bar.
2. Click **Edit**.

✓ **Tip:** In Off Air mode, you can double-click media elements to edit.

#### Video Timeline Editing Options

The following buttons are available for video editing:

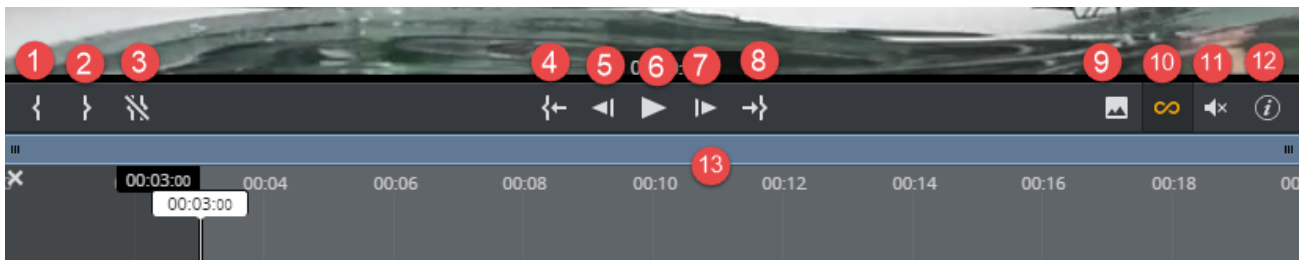

1. **Set Mark In:** Set an in point (**I**).
2. **Set Mark Out:** Set an out point (**O**).
3. **Clear Mark In/Out:** Clear in and out points (**SHIFT + C**).
4. **Go to In point:** Sets the playhead at the in point (**SHIFT + I**).
5. **Move 1 frame back:** Move the playhead one frame back (, **-comma**).
6. **Play/pause:** Play/pause the video (**SPACE** or **CTRL + SPACE**).
7. **Move 1 frame forward:** Move the playhead one frame forward (., **-period**).
8. **Go to Out point:** Sets the playhead at the out point (**SHIFT + O**).
9. **Set poster frame:** The current frame in the video editor will be used as thumbnail for the clip (**P**).
10. **Loop video:** Enable looping (**R**).
11. **Volume slider:** Adjust the clip volume (**M** to mute/unmute).
12. **List the keyboard shortcuts** (**SHIFT + K**).
13. **Zoom and pan:** Click and drag the edges of the blue bar to zoom and move it to pan the timeline.

**Info:** When setting a mark in point, the clip frame of this point will automatically be used as the thumbnail.

### 3.12.3 Editing Graphics

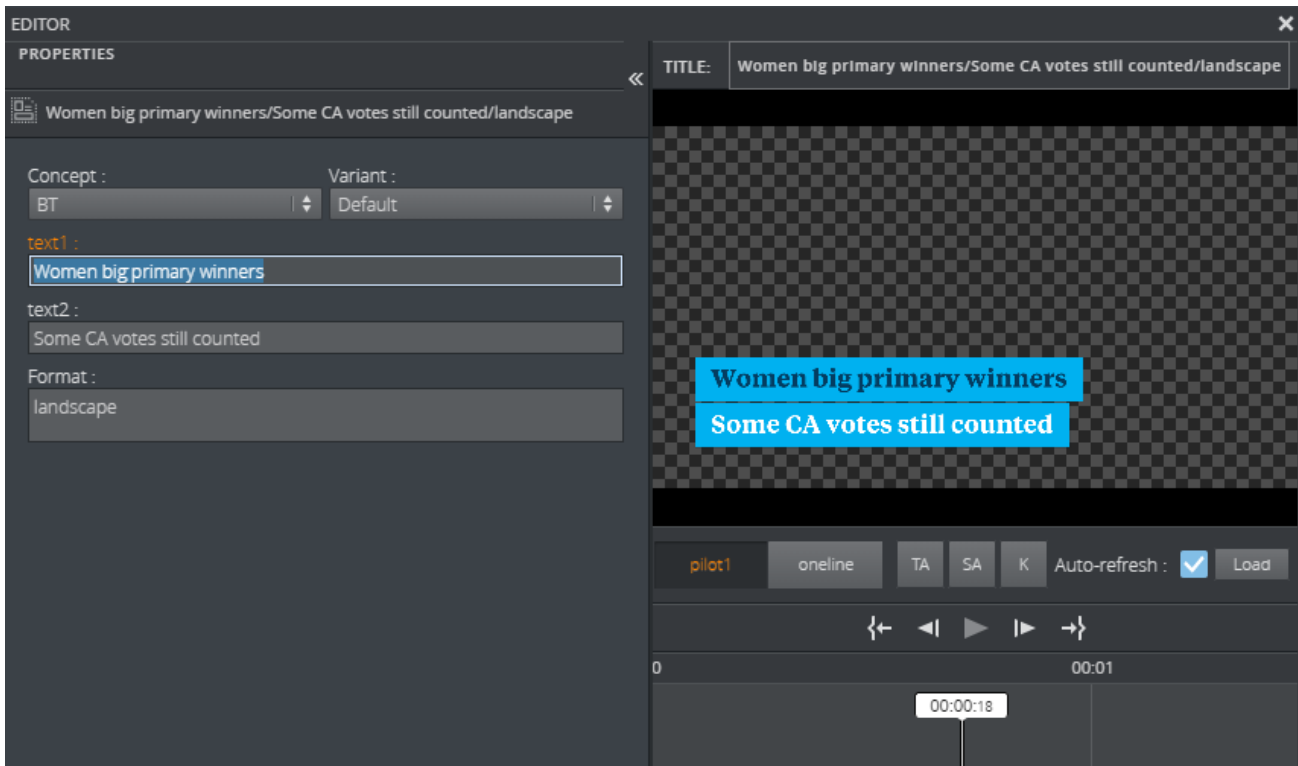

Open the Graphics Editor by right-clicking a graphics element and selecting **Edit**. Any changes made inside a graphical element are visible immediately.

On the left is the [Fill In Form](#), where you can edit the fields that are available in the graphical element.

On the right, there is a [Preview Window](#).

**Note:** All changes are live and cannot be cancelled.

#### Fill In Form

The window to the left is a Fill In Form for the graphics. It displays fields that are exposed by the designer in Viz Artist where the user can add content to the graphic. This can include text, options in a drop-down list or media placeholders for media assets. Once changes are made in the Fill In Form, the Preview Window immediately updates to display them (if **Auto-refresh** is toggled on).

#### Custom HTML

The Fill In Form in Viz Multiplay is auto-generated based on the fields in the Viz scene. To change the appearance of the form, it is possible to replace some or all of the form with your own custom HTML. Although this is an advanced feature, the end result is that the user (the journalist or whoever fills in information) can view a completely customized interface. To use this feature, see [the Template Builder manual](#).

## Maps

Maps from Viz World can be used in the Fill In Form if the graphics contains a **Map** field; this can be set in [Template Builder](#) version 1.0.2 and later. A Map field is generated when the Viz scene contains a map plugin.

Once there is communication with a Viz World server the user can select from a list of available maps in Viz World. In order to edit these maps, a local Viz World installation is required. Since Viz World only runs on Windows, the Map Editor is only available when Viz Multiplay is running on Windows machines.

### Viz World Configuration

Viz World must be configured in a Pilot Data Server to establish communication between Viz Multiplay and Viz World.

In the Pilot Data Server Web Interface go to the *shared\_curious\_server* parameter (see the Database Parameters in the [Viz Pilot guide](#)) through Settings and add a hostname in the value column.

In the value column, use either:

- hostname or IP

or,

- full URL. Here the port must be defined

**Info:** A Viz World server defined in the Viz Multiplay URL (maps=mapshostname) will override the server defined in the Pilot Data Server.

### Choosing Maps

To select a map, click **Choose map** in the Fill In Form.

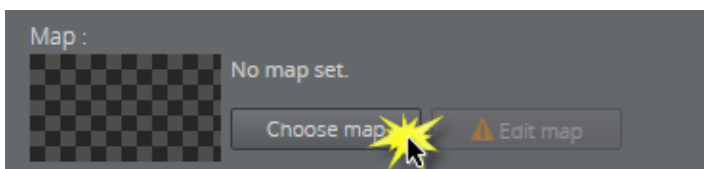

A dialog appears listing the maps that are available from the Favorite folder in the Viz World Map Editor.

Select a map.

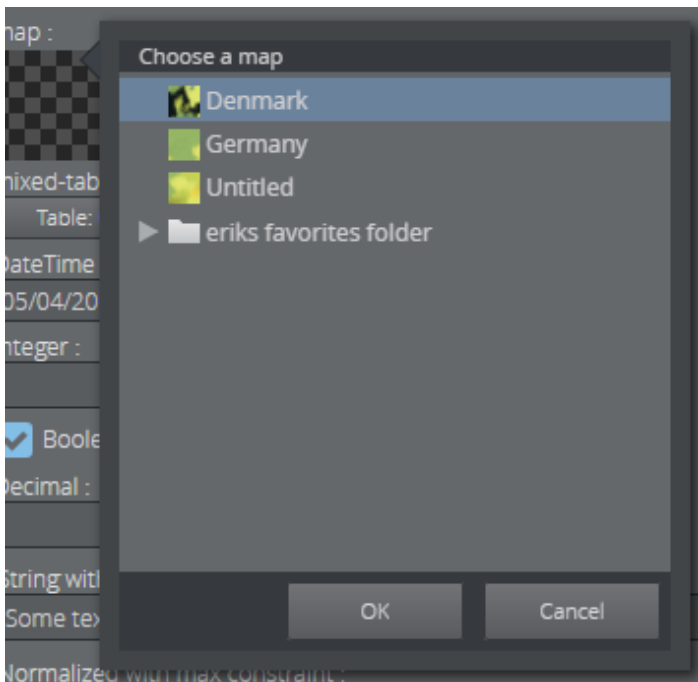

The map appears in the thumbnail in the Fill In Form and in the graphic in the preview window.

Choosing a map in this way only requires communication with a Viz World server. However, a local Viz World installation is required to edit maps. See below.

### Edit Maps

The **Edit map** button is enabled only when a Viz World client 17.0 or higher is installed on the computer running Viz Multiplay, and the Map Client service is running. Normally the service is located here:

C:\Program Files\Vizrt\Common\Maps\MapClient.Service.exe

- Double click this file. A window pops up and closes, and the service is now running.

Once a map is chosen and there is a running Map Client on the machine, the map can be edited. Click **Edit map**.

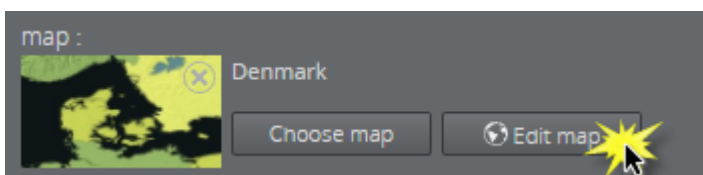

This opens up the Viz World Map Editor. All edits are performed inside this client, which means that Viz Multiplay has no control over your actions here.

After the map has been opened in the Map Editor the name is changed to *Denmark [modified]*, for example, indicating that the map has been edited.

To cancel the edit mode, click **Cancel edit**.

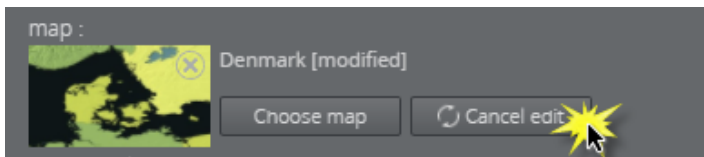

**Warning:** Clicking outside the Viz World Map Editor while it is open hides the window behind the Viz Multiplay window. Viz Multiplay will keep listening for data coming from Viz World until the window is closed. Recover the Map Editor from the taskbar and close it, or click **Cancel edit** from Viz Multiplay.

Although the map thumbnail view will not be available after saving and re-opening a template including a map, the map will still be there. Once the Viz World Map Editor is opened and communication is established, the map thumbnail view is available.

The Preview Window will update according to the selected map and edits performed on it.

### Warning Signs

Warning signs and grayed out map buttons indicate that the Viz World service is unavailable or that there is an error from the service.

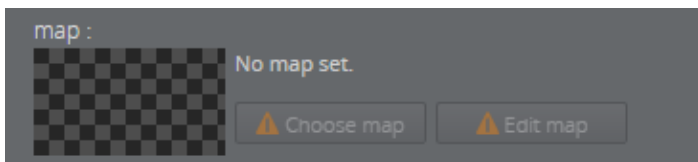

If no map is chosen or no default value is found, the **Edit map** button will be grayed out with a warning sign. A map must be chosen before edits can be made.

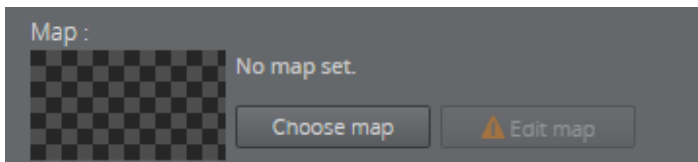

If a map is chosen, but the **Edit map** button is still grayed out, the map client is not detected.

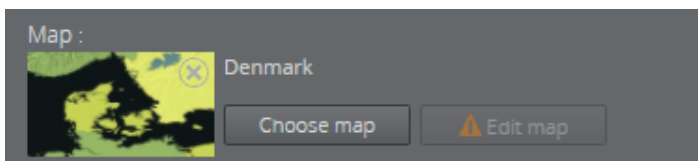

### Feed Browser

If a graphic template contains a **Browse** button in the Fill In Form, the user can browse for a feed entry. The feed entry URL is pre-set in the template. Use **Template Editor** to change a field type from pure text to a Browse button linked to an Atom feed, or a dropdown with fixed options.

Using the Feed Browser in the Fill In Form for a graphic is shown below:

1. Click the **Browse** button to open the Feed Browser.

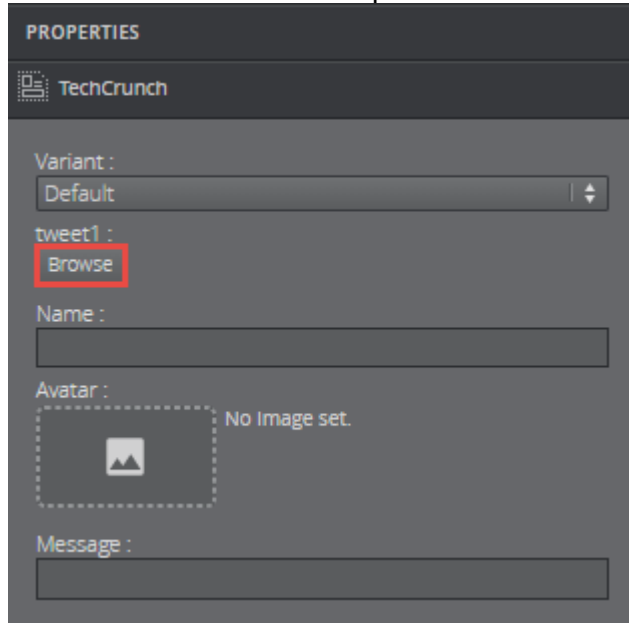

2. The Atom entries of the feed will be presented as thumbnails if available. Select one of the entries and click **OK**.

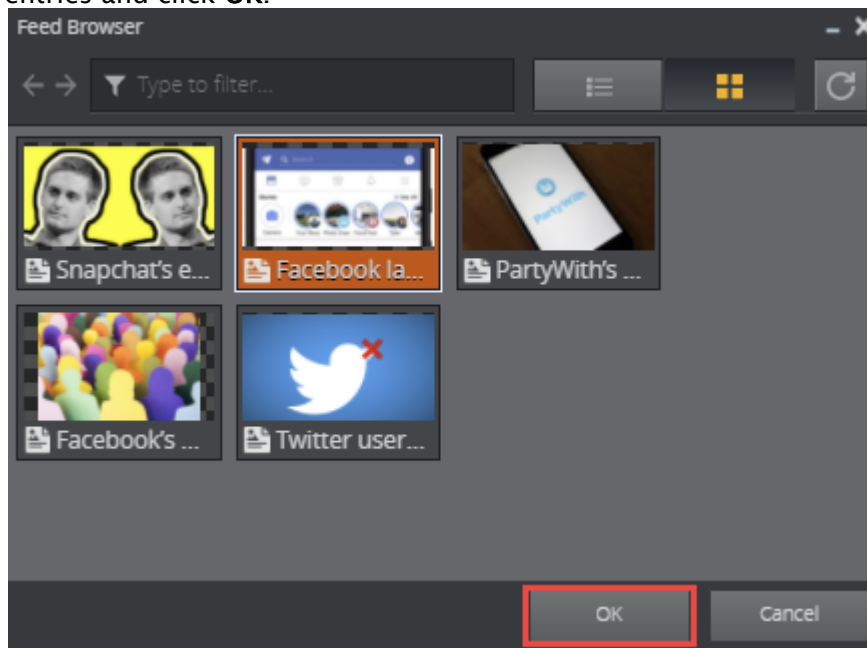



3. Information from the entry will be used to fill in the feed browser fields in the template.

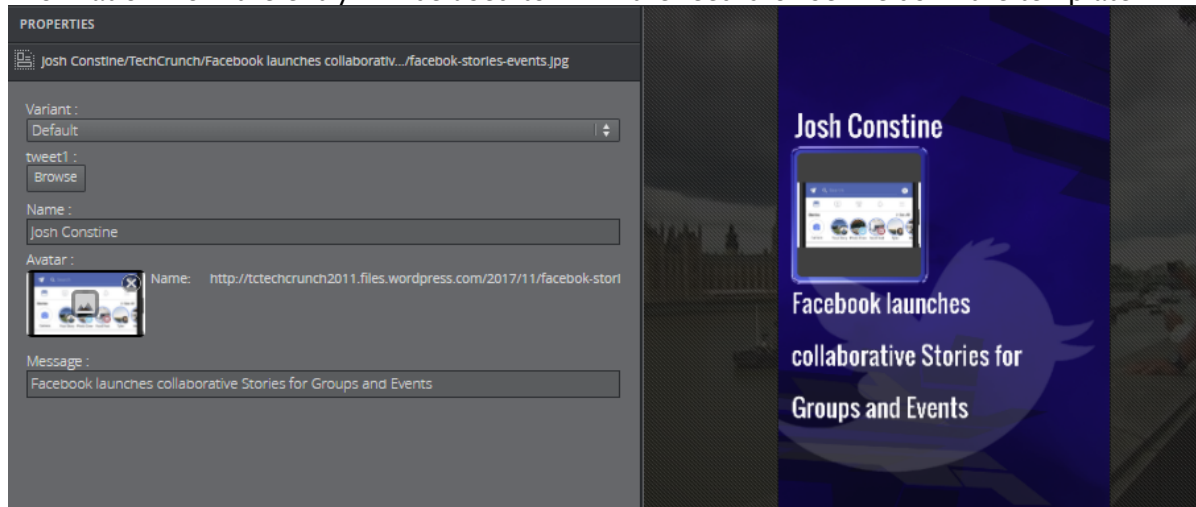

## Preview Window

The Preview Window displays snapshots of the graphics and provides the user with an idea of how the graphics will look when played out in high resolution on a Viz Engine. The Viz Engine generate snapshots requested by the Preview Server. These are the functions of the Preview Window:

- **TA:** Show/hide the Title Area in the edit window.
- **SA:** Show/hide the Safe Area.
- **K:** Show the key signal for the graphics.
- **Preview points:** If the scene contains named preview points, such as stop points and/or tags in the director called **Default**, these are shown as buttons on the toolbar. If there is not enough space for the buttons, they appear in a drop-down list instead. Selecting a preview point shows a preview of the scene at the given point, and the playhead jumps to the point in time where the preview point is set.
- **Scrub** the timeline back and forth by clicking on it or moving the playhead. If the scene does not have a director called **Default**, or the Default director does not have a duration, the timeline will be disabled.
- **Auto-refresh:** Auto-refresh is located at the bottom of the Preview Window and is by default toggled on, which means that the Preview Window updates once there are any changes in the Fill In Form.

Toggle off **Auto-refresh** to turn this functionality off. To refresh the Preview Window in this

mode click the **Refresh** button  Auto-refresh :  or click inside the Preview Window.

- **Load:** Clicking this button will load the animation of the graphics. Once loaded, indicated by a green line at the bottom of the timeline editor, media controls appear allowing the

graphics animation to be controlled in the Preview Window:

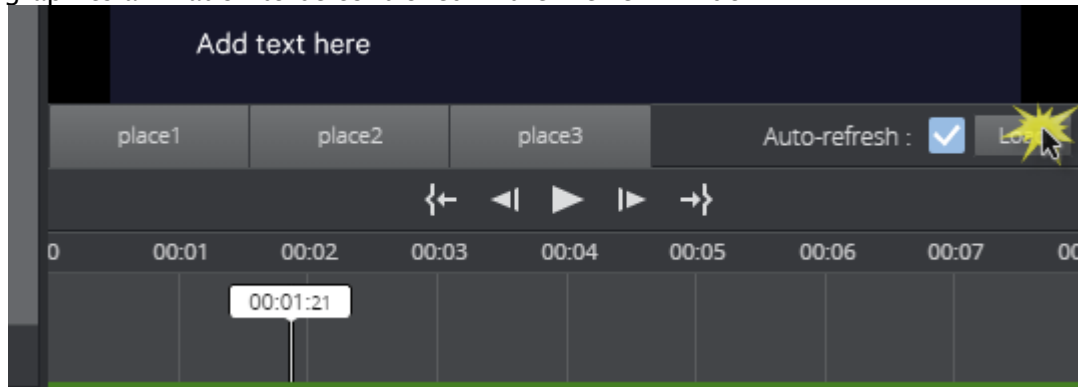

**Warning:** The load animation feature sends many snapshot requests to the Preview Server. Many users sending requests at the same time could lead to performance issues.

### 3.12.4 Editing Presets

There are two types of presets, each with their own editing options: [Preset](#) and [Filled Preset](#).

#### Preset

A Preset defines the layout of the graphics channels on a video wall.

New presets are created in the [Videowall Tab](#). Drag presets to the [Using Shortcuts](#) in order to switch between layouts during a broadcast and send presets to air.

This section covers the following:

- Create a preset
- Send a preset to air
- Open the Video Wall Designer

#### Create a Preset

Add a new videowall preset.

1. Click the [Videowall Tab](#) in the [The Sources Pane](#).

2. Click the + icon.

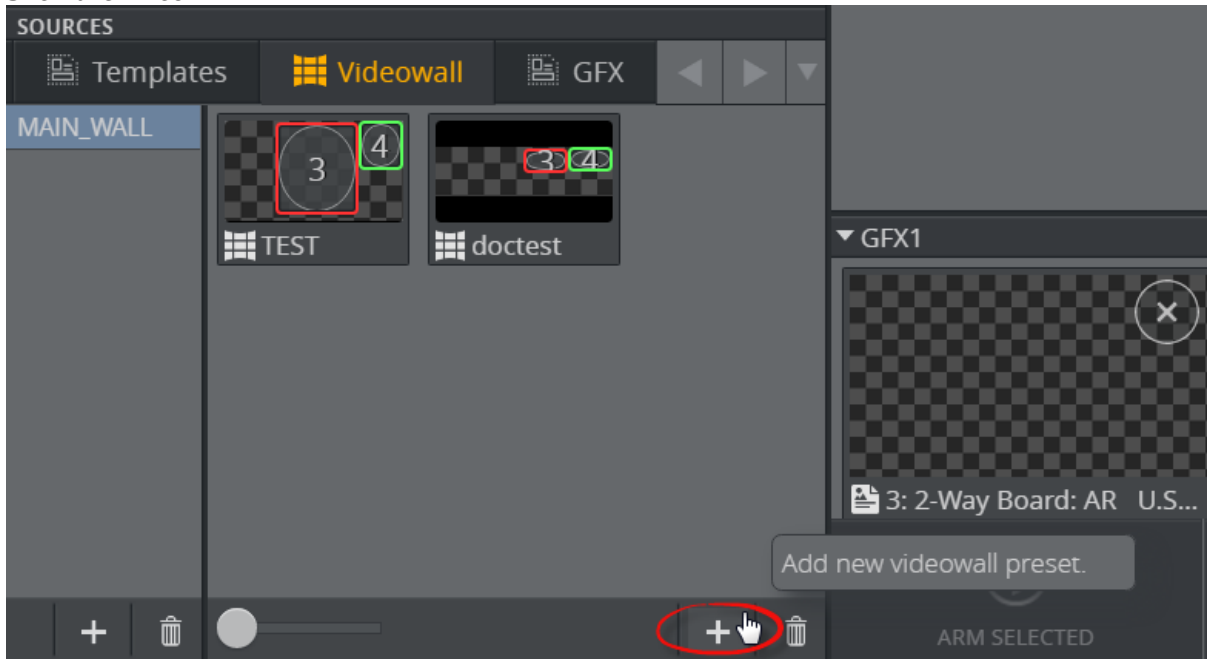

3. Give the preset a title.

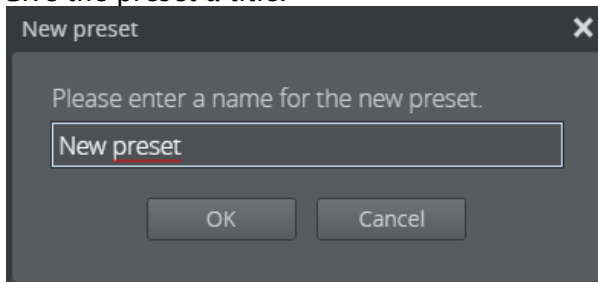

4. Click **OK**.

## Send a Preset to Air

Send a preset to air via the Shortcuts Bar.

1. Drag a preset to the Shortcuts Bar.

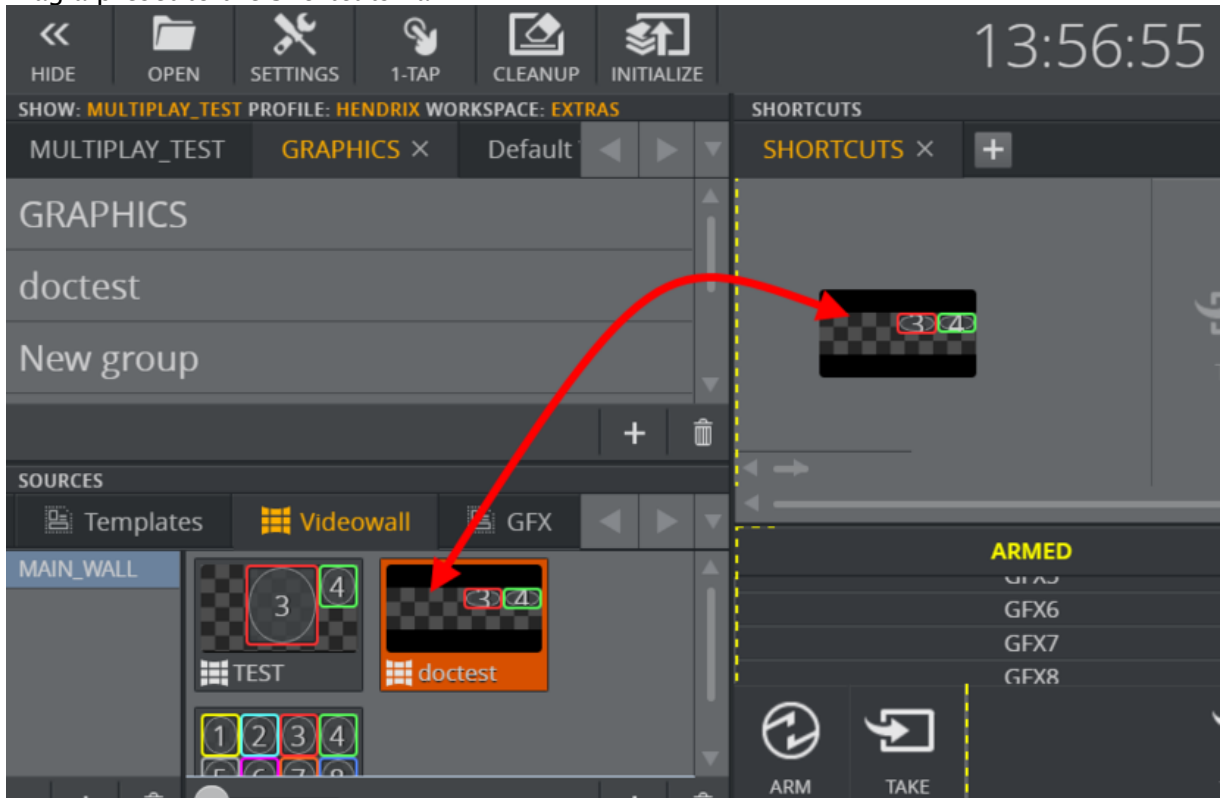

2. Click the preset to send it to the Armed column.

**Note:** In 1-Tap Mode, clicking a preset sends it straight to On Air.

3. Click the preset in the Armed column, or click the Take button.

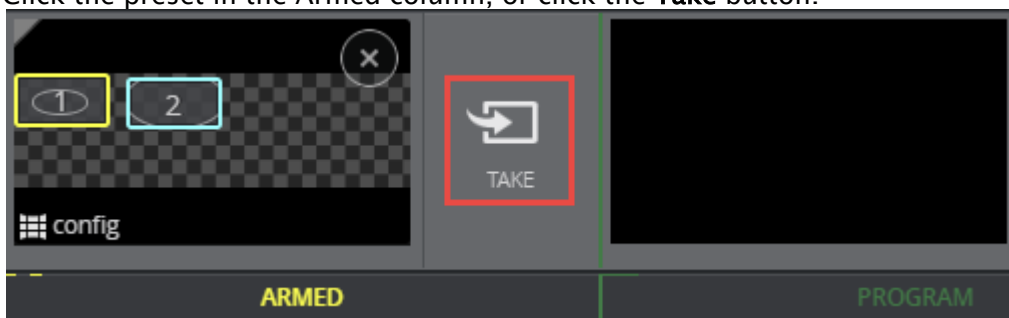

4. The preset moves to the Program column and is now on air.

## Open the Video Wall Designer

Edit the preset layout in the [Video Wall Designer](#). There are two ways to access the Video Wall Designer, as described below:

### Access the Video Wall Designer via the Videowall Tab

1. Right-click a preset in the Videowall Tab.

2. Click **Video Wall Designer**:

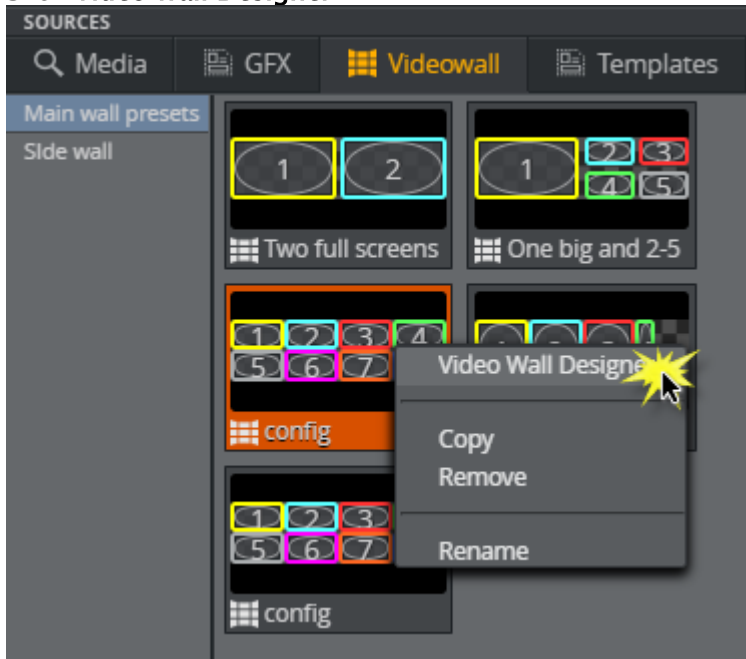

**Access the Video Wall Designer via the Shortcuts Bar**

1. Right-click a preset in the Shortcuts Bar.
2. Click **Video Wall Designer**:

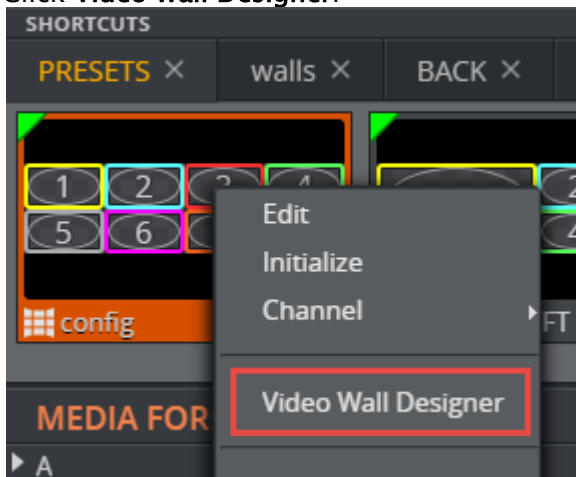

**Filled Preset**

A Filled Preset is a video wall layout which also includes predefined content. Use Filled Presets to quickly send content onto your video wall. Content can only be added to presets that are in the [Using Shortcuts](#).

Edit the content in a preset in the Working with Preset Content (right-click a preset in the Shortcuts bar and select **Edit Content**).

### 3.12.5 Renaming Playlist Entries

There are two ways to rename media items added to a playlist in the [Using Shortcuts](#) or [Media Column](#):

- [Rename from the context menu](#)
- [Rename from the Editor](#)

#### Rename from the context menu

1. Right-click an item in either the Shortcuts Bar or Media Column.
2. Click **Rename**.
3. Enter a new title and click **OK**.
4. The new title is shown on the element.

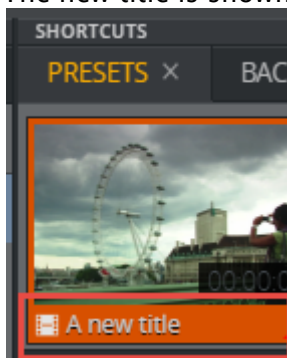

**⚠ Note:** The new name will not be overwritten by the auto-generation process when entering new field values in the Editor.

#### Rename from the Editor

1. Right-click an item in the Media Column.
2. Click **Edit** to open the Editor.
3. Click the title text field.

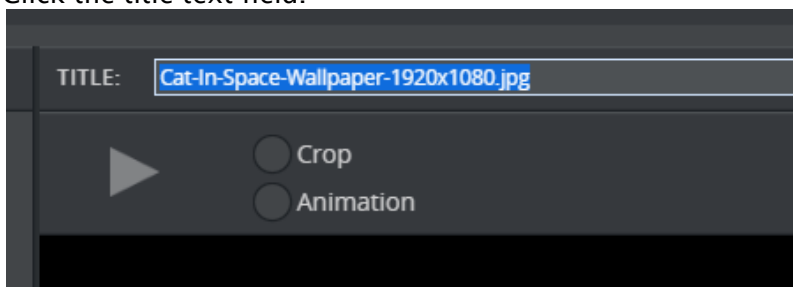

4. Enter a new title.
5. Press **ENTER**.
6. Click **x** to close the editor. The element is shown in the Media Column with the new title.

## See Also

- [Presets](#)
- 

## 3.13 Arming And Taking Elements

This section covers:

- [Media Pane](#)
- [Armed](#)
- [Program](#)
- [Arm and Take Multiple Elements](#)
- [Reload Scene](#)

### 3.13.1 Media Pane

- Elements that are ready are listed in the [Media Column](#), while the [Armed](#) and [Program](#) columns display elements currently armed or on air.
- [Arm and Take Multiple Elements](#) to manage multiple channels simultaneously.
- The [Using Shortcuts](#) is used to arm and take presets and other shortcuts.

 **Note:** Adding videos to a graphics-only channel or graphics to a video-only channel will result in the element not being played out correctly. Composite elements will only work on channels that support both graphics and video.

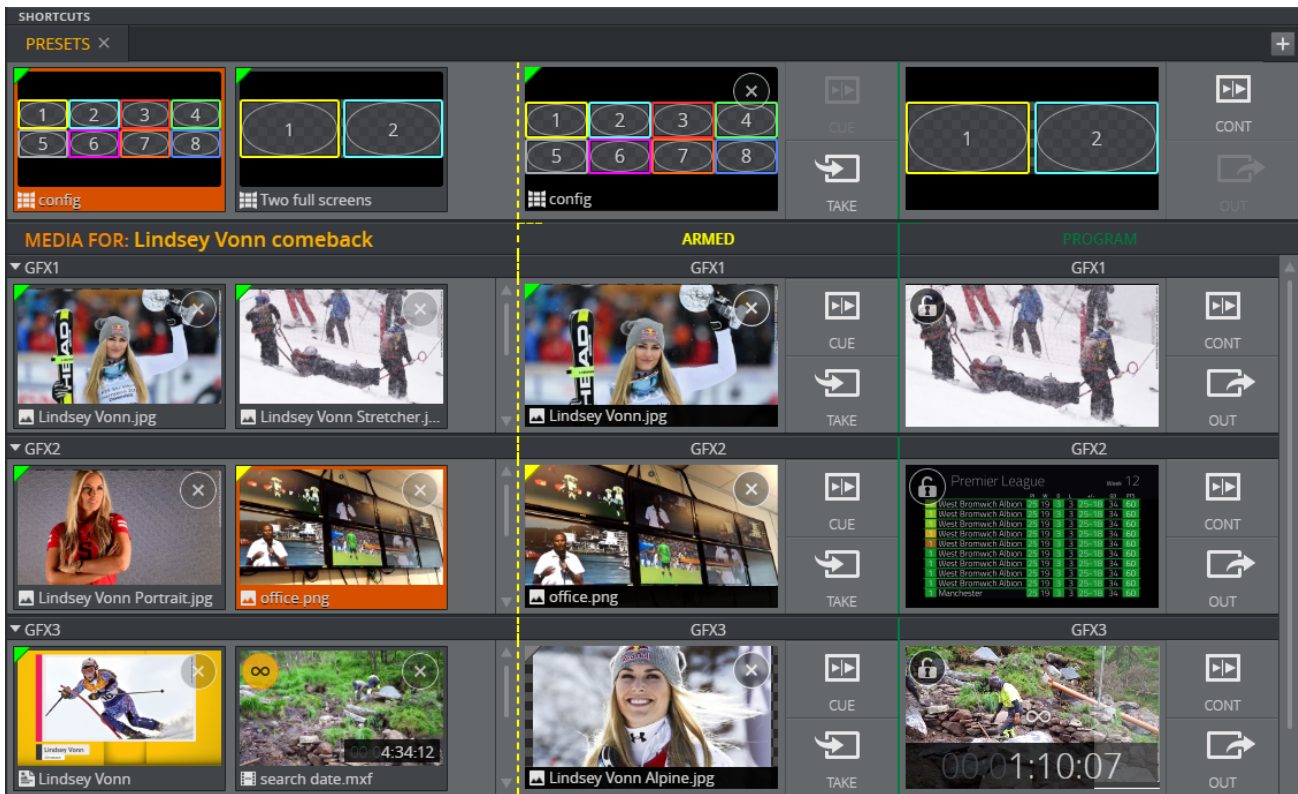

## Media Column



Elements that are ready to be played out are on the left. These elements belong to a page list or a playlist, and are assigned to one channel in the active profile.

**Note:** All changes made to elements in this column are reflected in Viz Trio.

This section covers the following topics:

- [Options in On Air mode](#)
- [Shortcut menu in the Media Column](#)

With [On Air Mode](#) enabled, you can prepare (arm) and play out elements. Either:

- **Right click** an element to use the context menu.
- **Click** an element to move it to [Armed](#).
- **Drag** an element to Armed or Program in another channel to make a copy there (the original remains in the source channel).
- **Drag** an element to the Media Column in another channel (this removes the element from the source channel).
- Turn **Looping** ON  or OFF .



**Note:** You cannot change the looping setting once the clip is playing. Take out the clip to stop looping.

- **Delete** an element - (X Button) or **Remove** from the context menu.

**Note:** Show or hide the X button in the General tab in Settings.

A thumbnail indicates that the element is still **loading**:

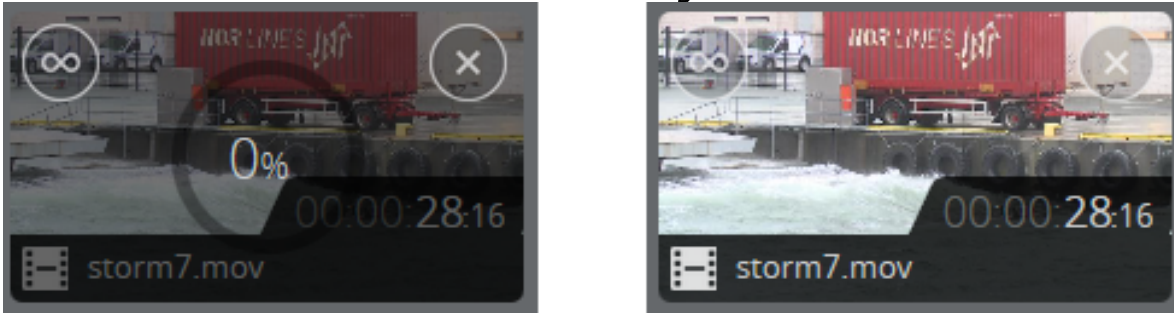

In **1-Tap Mode**, you can:

- Click an element to move it directly to **Program**.

When elements have been selected in several channels (one element per channel):

- **Arm Selected:** Send all selected elements to **Armed**.
- **Take Selected:** Send all selected elements to **Program**.

## Shortcut menu in the Media Column

Right-click elements (videos, images and graphics) in channels in the Media Column to open the menu:

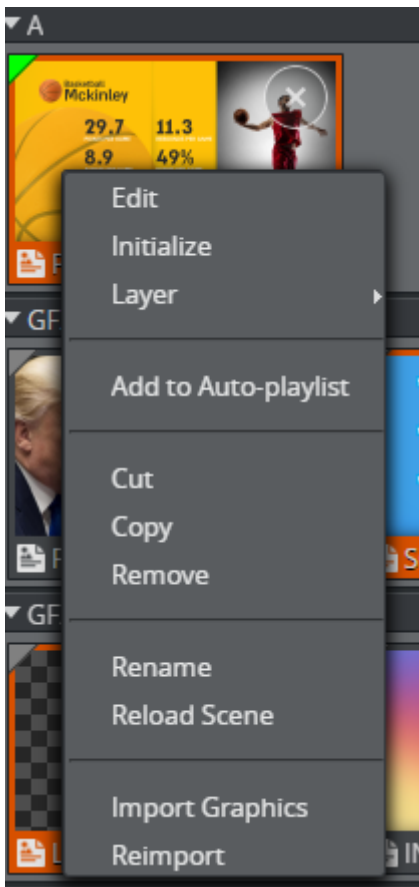

- **Initialize.** Loads the resources of this element into the memory of the renderer. Initialize is available for images and graphics and ensures instant Take playback.

**⚠ Caution:** Initialize may disrupt animations or clips playing on the renderer. It's recommended to initialize before the broadcast starts, or when there is low activity on the renderer.

The **colored triangle** in the top left corner of the element shows whether the resources are loaded on the renderer. Green is loaded, yellow is loading, and gray is unloaded.

**⚠ Note:** If the element is not loaded, there may be a delay before the renderer plays the graphics when a Take is executed.

- **Layer:** (non-GFX channels only): Set the Viz layer (FRONT, MAIN or BACK).
- **Add to Auto-playlist:** Only media elements from the same group can be included on an Auto-playlist.
- **Reload Scene:** from the Graphic Hub.

**⚠ Note:** Reload Scene is only visible when right-clicking graphics in the media, armed and program columns. See [Reload Scene](#).

- **Import Graphics:** Import graphics directly from Viz Graphics Hub into the channel.

### 3.13.2 Armed

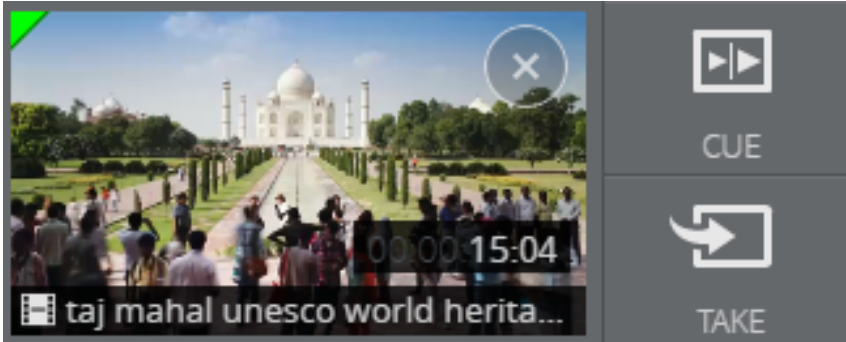

When armed, content is ready for playout on the channel.

**Note:** Arming does not prepare an element for playout on the renderer - it simply shows you what is going to be played out next.

#### Arming clips

When clips are moved to Armed, they are prepared on the Viz Engine. The clip is then set to its first frame in the background of the player, ready to be taken with less latency than if it were not armed. Preparation is done in the background, without disturbing the running clips. The **green triangle** shows that the renderer is ready and the clip will play out instantly.

**Note:** Users with the same active workspace share the same armed column.

- Click an element to take it to [Program](#).
- Click the **TAKE** button to take the element to [Program](#).
- Click the **CUE** button (enable this in Settings) to send the element to [Program](#) in the first frame in the renderer ready to be played out.
- Click the **CONTINUE** button (enable this in Settings) to continue the graphics or video on the external preview engine. Only available if external preview is used.
- Click the **TRANS** button (enable this in Settings) to swap the content in the Armed column and the Program column.
- Drag an element to [Armed](#) or [Program](#) in another channel to make a copy there (this does not affect or take the original armed element).
- **Take All:** Send all armed elements, for all channels, to [Program](#).
- **Cue All:** Send all armed elements, for all channels, to [Program](#) in the first frame in the renderer ready to be played out.
- **Trans All:** Swap all elements in the armed column with the elements in the Program column.
- See the **Looping** status of the video.

**Note:** The looping setting cannot be changed in the Armed column. Use the looping button in the Media column.

- **Remove** an element from the Armed column by clicking **X**.

### Armed Shortcut Menu

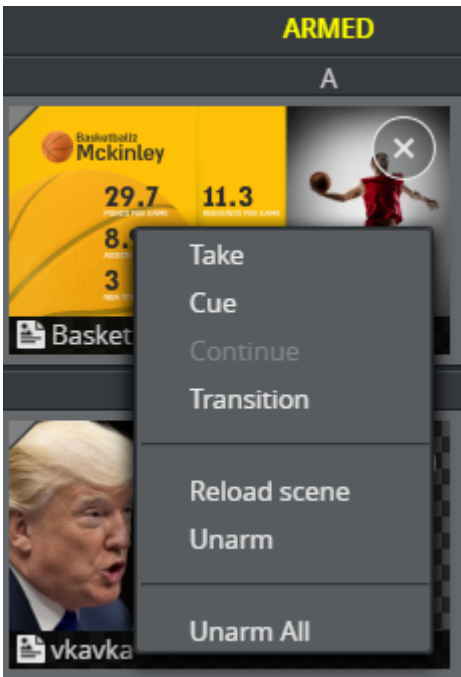

- **Continue:** on the external Preview renderer. Only enabled if an external preview is configured for a video wall.
- **Transition:** Swap the content in the Armed column and the Program column.

### 3.13.3 Program

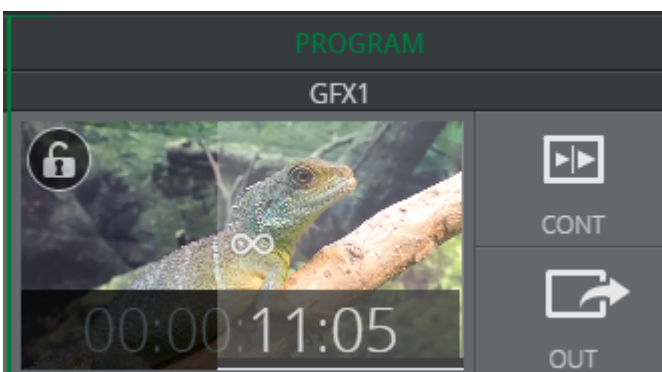

Elements shown in the Program column are currently playing on air in the channel.

**Note:** With Media Sequencer version 5.0 or higher, the Program column will not only show the last taken element, but snapshots of all the layers that are in the renderer at a given moment. This means that when a Transition Logic layer is taken in (for instance a banner), and another layer is taken in (for instance a clock or a side panel) - the Program column will actually show both of these layers, and not only the last taken element.

- Click **CONT** to continue a graphic element or Cued elements.
- Click **OUT** to take out the element.

**Note:** With Media Sequencer version 5.0 or higher, **OUT** takes out content on all layers in the renderer, including Transition Logic layers - and not only the last taken element.

**Important!** **OUT** will not be enabled for a main or shortcut channel that has a **video wall preset** on air. A preset should always be on air when operating a video wall - even if the channels are empty. The preset ensures that content can always be played out directly in the channels on the wall.

- **Drag** an element to **Armed** or **Program** in another channel to make a copy there (this does not affect the original program element).
- **Continue All:** program elements in all channels, including cued elements.

**Important!** **Continue All** will not continue elements in the Shortcuts Bar. Only elements in regular channels visible in the interface (including collapsed channels) are affected. Channels hidden by the active Workspace are not affected.

- **Out All:** Take Out all program elements in all channels.

**Important!** **Out All** will not take out elements in the Shortcuts Bar. Only elements in regular channels that are visible in the GUI (also collapsed channels) are affected. Channels hidden by the active Workspace are not affected. **Out All** has a fail-safe that provides an extra confirmation step when clicked.

- See the **Looping** status of the video.

**Note:** The looping setting cannot be changed when the clip is playing. To stop looping, take out the clip and toggle the looping **OFF** in the Media column.

- **Display a snapshot** of the clip/graphic (clips can also play depending on the setting **Play videos locally in Program** in **Settings**).

**Note:** The preview shown in the Program column is an indication only and may not be completely in sync with the actual output.

## Locking a Channel

Each Program channel has a **lock symbol** (enabled in settings) to hinder any changes being made to it.

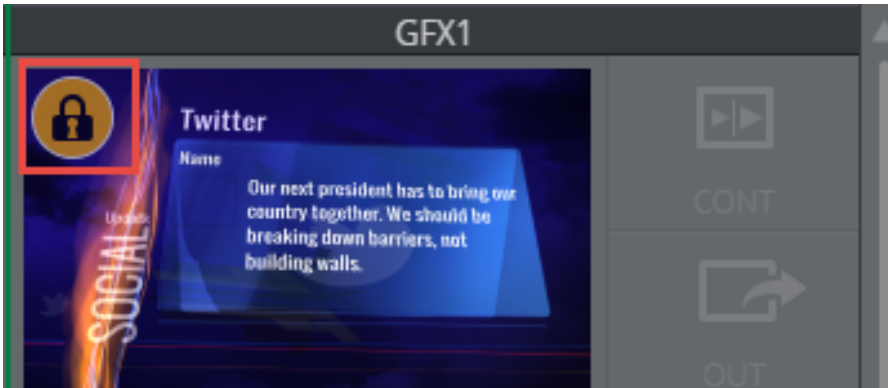

You can lock a channel if it is to stay on air. The **Continue** and **Out** and **Out All** and **Continue All** buttons will then be disabled. A common use case can be to lock some channels, and click **Continue All** - only the unlocked channels will receive the Continue command.

**Note:** The lock only applies the local client. Other Viz Multiplay clients can still change the content of the channel.

## Time Remaining

The time remaining for a clip is indicated with a **gray** progress bar. **Orange** shading indicates <20 seconds remaining, and red indicates <10 seconds remaining. Only the gray progress bar is shown on looping clips.



### 3.13.4 Arm and Take Multiple Elements

#### Action Bar

**Note:** The Action Bar is hidden in Off Air Mode.

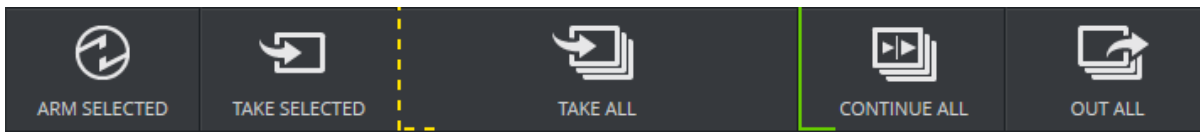

- **Arm Selected:** Send all selected elements in the **Media Column** to **Armed**.

**⚠ Note:** Arming clips cues them on the Viz Engine so that they are ready to be taken with less latency than if they are not armed first.

- **Take Selected:** Send all selected elements in the **Media Column** to **Program**.
- **Take All:** Send all **Armed** elements, for all channels *and shortcuts*, to **Program**.
- **Continue All:** Continue all **Program** elements, in all channels.
- **Out All:** Take Out all **Program** elements, in all channels.

**⚠ Note:** The **Using Shortcuts** is unaffected by **Continue All** and **Out All**.

### 3.13.5 Reload Scene

Update On Air graphics with the reload scene option. This feature is useful when changing scenes on the fly in Viz Artist and quickly taking them to air.

#### To Activate Reload Scene

- Right-click a graphic in the media pane (shown below) or in the armed or program columns.

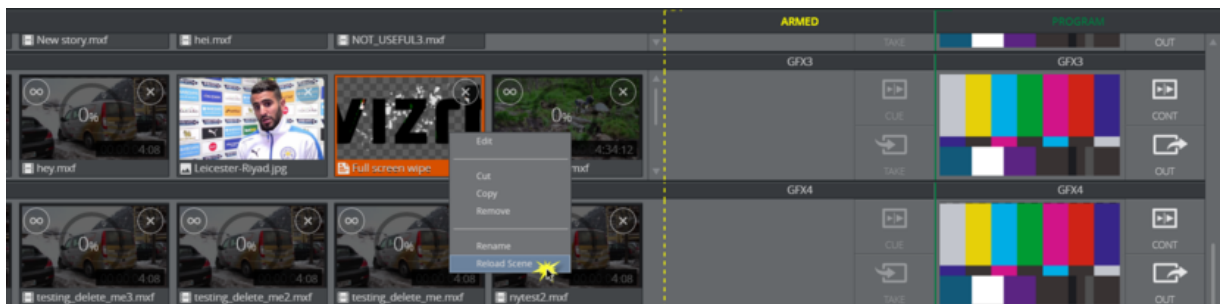

#### Using Reload Scene

A graphic is showing live on a video wall. As the graphic is in use, a scene designer changes it in Viz Artist.

Bring the changes to air:

1. Send a graphic to air in the program column.
2. The scene, which is now in use on a video wall, is opened in Viz Artist and changed by a scene designer. The new scene is saved in the Graphic Hub.
3. Right-click the graphic in the program column of the channel where the graphic is playing out and click **Reload Scene** to show the new, updated scene.

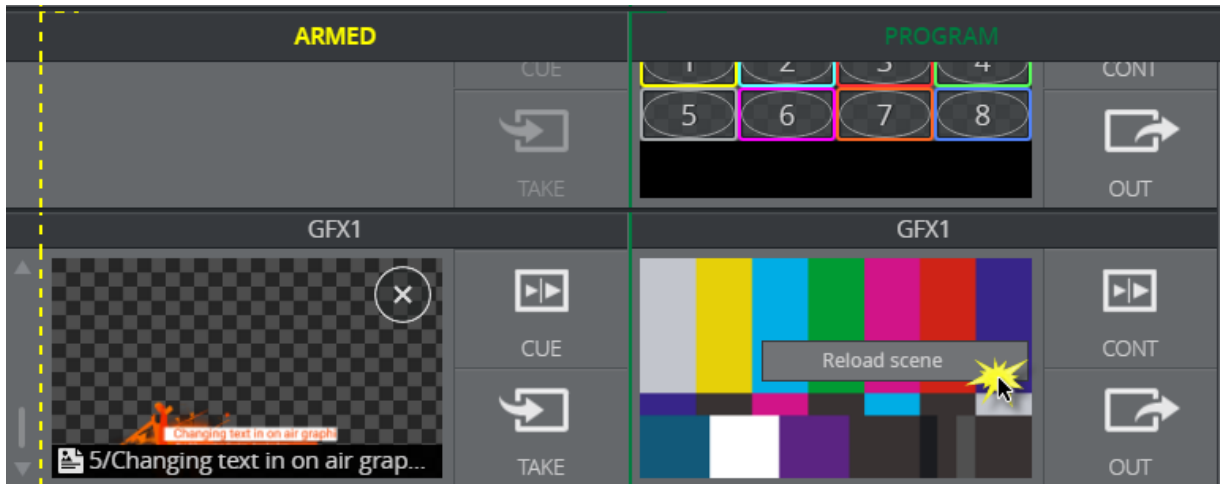

### Tips for Using Reload Scene

Scenario	Solution
<p>Default data is inserted into an On Air graphic's editable field after clicking <b>Reload Scene</b>. This only applies for graphics with a payload editor, not for, for example, graphics such as a bug.</p>	<p>Once a graphic is ready to be reloaded, take it out from the program column. Locate it again in the relevant channel in the media pane and click <b>Reload Scene</b>. You can now send it to air with the new changes.</p>

## 3.14 Organizing Media Content

This section contains the following topics:

- [Browse Shows Window](#)
- [Show Pane](#)
- [Locating Page Lists, Playlists and Groups](#)
- [Add, Delete or Rename a Group](#)
- [Move Groups to Other Playlists in the Show Pane](#)
- [Add a New Playlist](#)
- [Working with Playlists](#)

### 3.14.1 Browse Shows Window

Click the **Open** button on the [Toolbar](#) to open the Browse Shows Window.



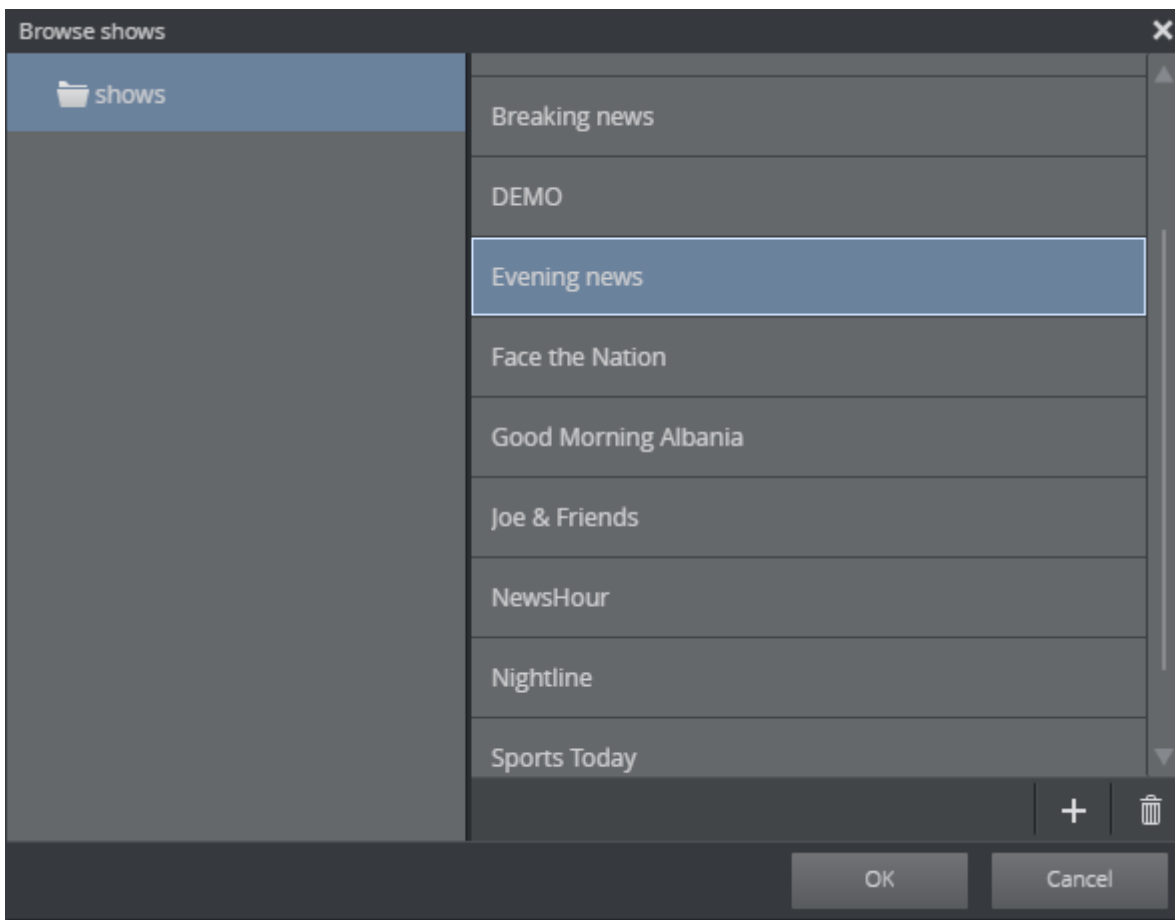

Open or delete existing **shows** or create new shows. Rename a show by selecting it and pressing **F2**. Select a show to open it in the [Show Pane](#).

### 3.14.2 Show Pane

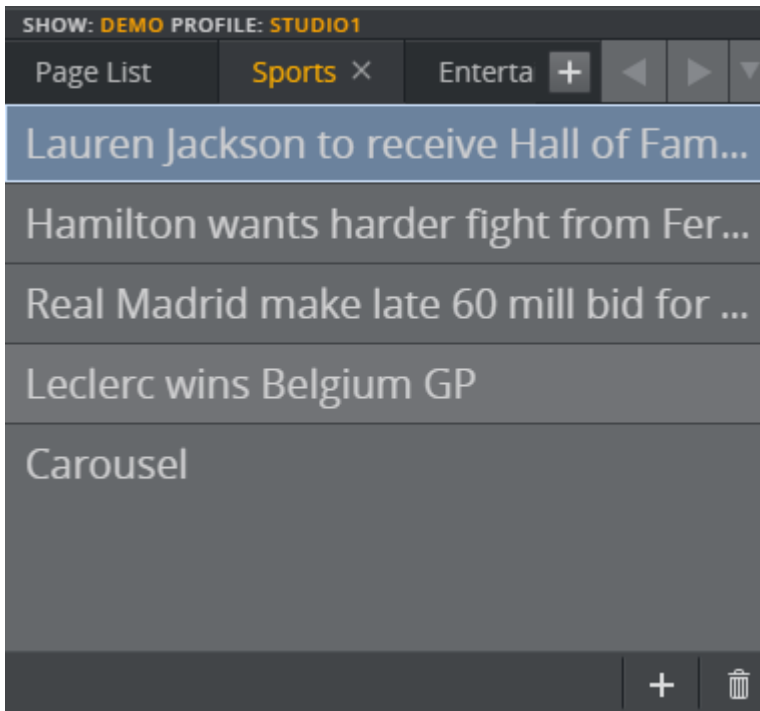

The Show pane at the top left of the main window displays the playlists and groups that are part of your show and connected to a certain profile. The **Page List** contains the name of the show; the other tabs are playlists.

### 3.14.3 Locating Page Lists, Playlists and Groups

Each tab contains Groups (3), and each group contains the media elements for a story. Select a group to load related media elements into the [Media Column](#).



### 3.14.4 Add, Delete or Rename a Group

#### Add a New Group to the Bottom of the List of Groups

1. Click **Add (+)** at the bottom of the show pane:

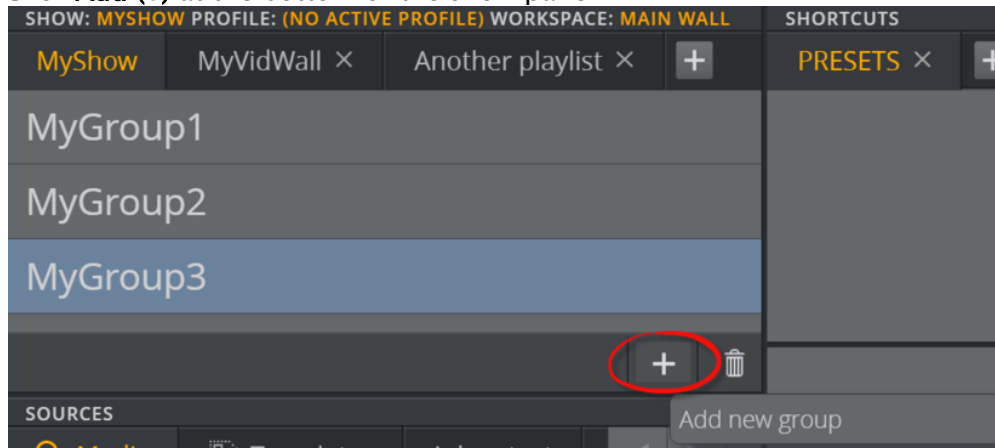

2. Give the group a name and press **ENTER**.

#### Insert a Group into a Specific Spot in the List of Groups

1. Right-click a group and select **Insert new group** from the shortcut menu.

**IMPORTANT!**

**Important!** The new group will be inserted directly above the group you right-click.

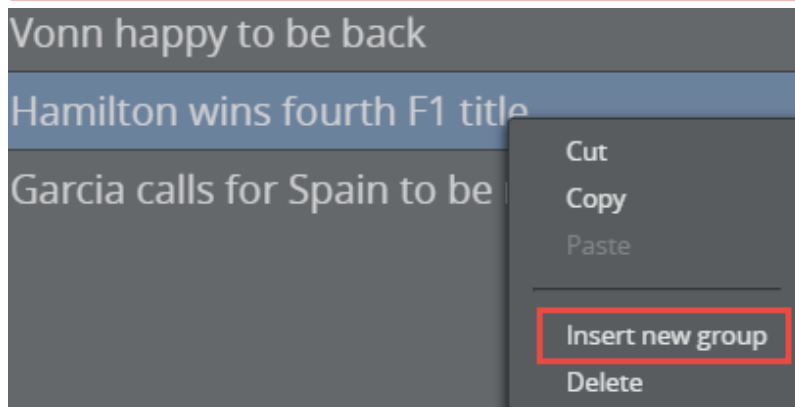

2. Give the new group a name and press **ENTER**.

## Delete a Group from the Show Pane

Right-click a group and select **Delete** from the shortcut menu, or

1. Click the trash can icon at the bottom of the show pane.

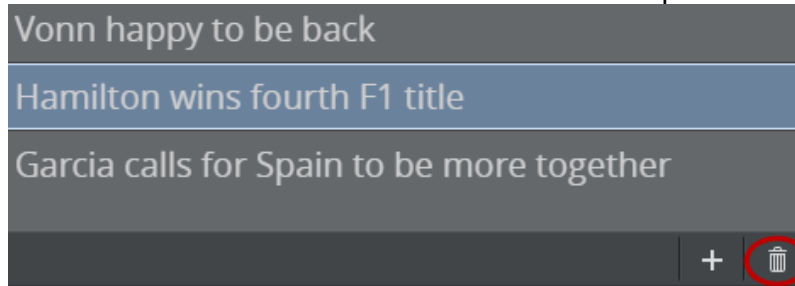

2. Click **Yes** when prompted.

## Rename a Group

1. Double-click a group.
2. Enter a new name.
3. Press **ENTER**.

✓ **Tip:** Groups can also be created and modified in Viz Trio.

### 3.14.5 Move Groups to Other Playlists in the Show Pane

Move a group by dragging, with a copy/paste operation using standard Windows keyboard shortcuts or via a group's shortcut menu.

#### Workflow Examples

Drag a group to another playlist tab:

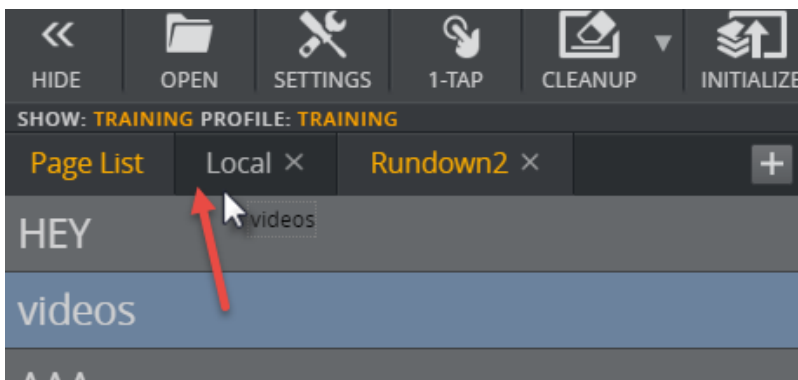

You can also move a group using **CTRL + C** and **CTRL + V** or the shortcut menu:

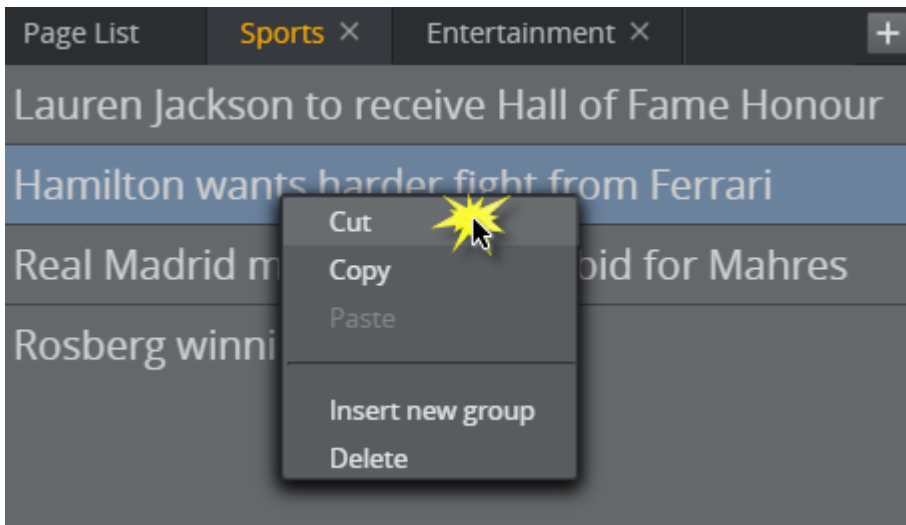

### 3.14.6 Add a New Playlist

1. Click **Add (+)** to create a new playlist or open an existing external playlist.

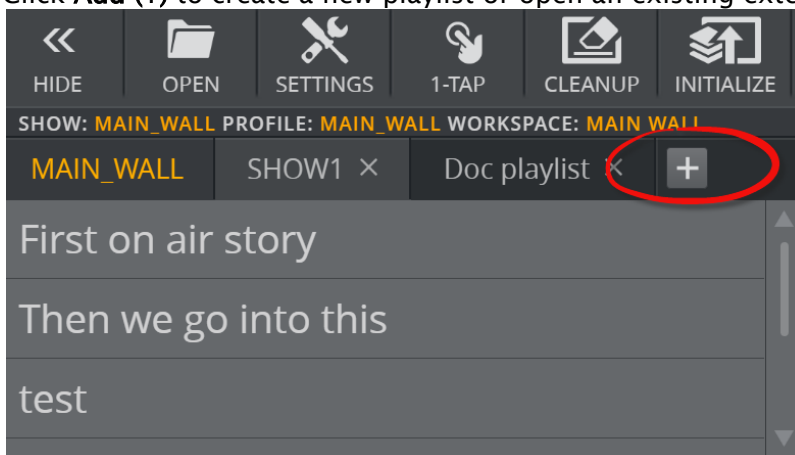

- a. **Create new playlist:** The playlist will be owned by the show and appear as a tab in the Show pane but will not be visible in the show/playlist directory tree.

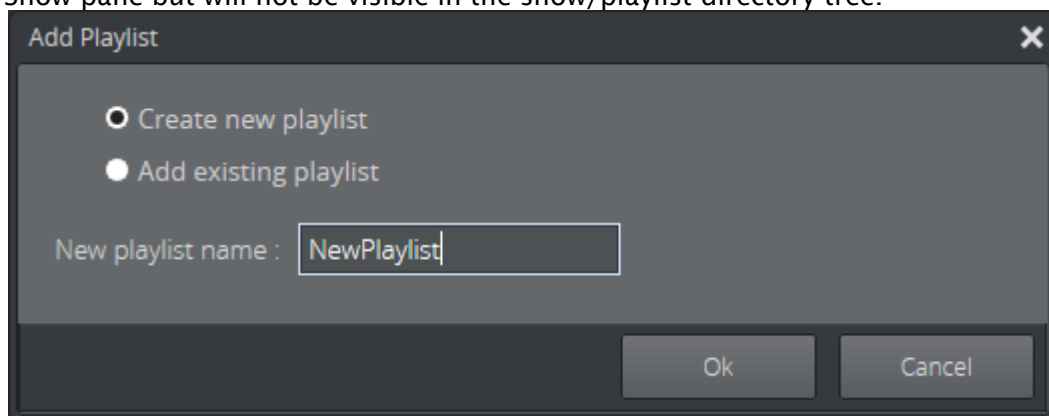

- b. **Add existing playlist:** Open existing playlists from Viz Pilot or other newsroom systems.

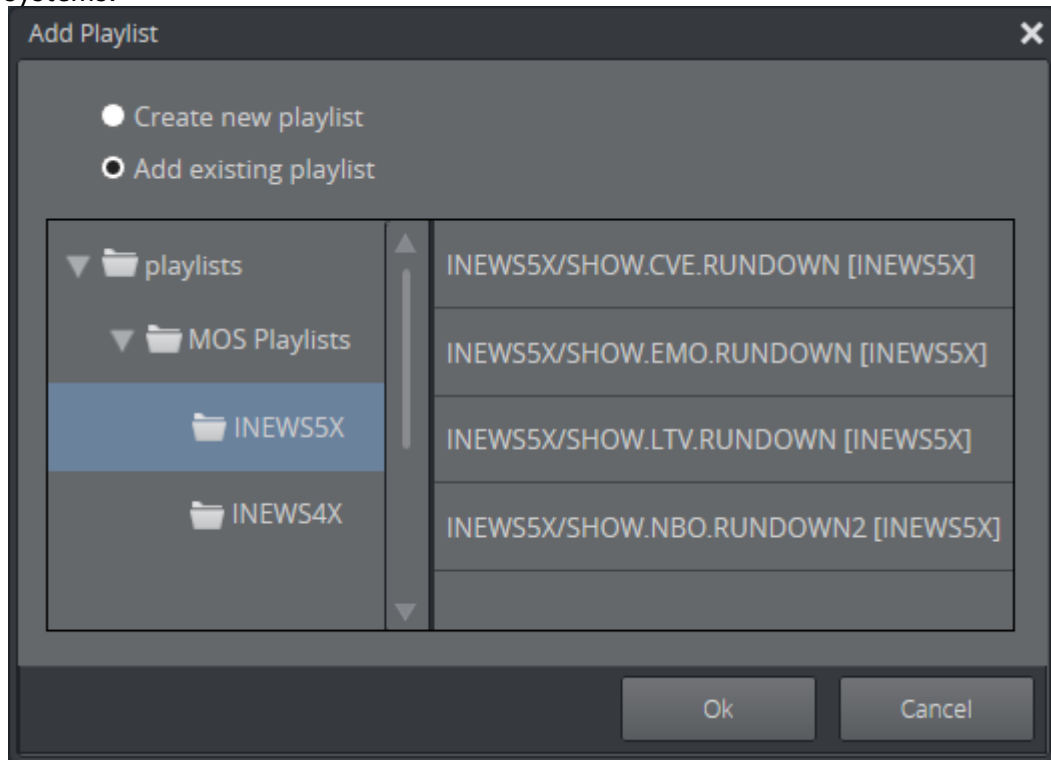

2. Click **X (Close)** to delete an internal playlist or remove the reference to an external playlist.
3. Click **Ok**.

✔ **Tip:** Playlists can also be created and modified in Viz Trio.

### 3.14.7 Working with Playlists

#### Rename a Playlist

1. Double-click the playlist title.

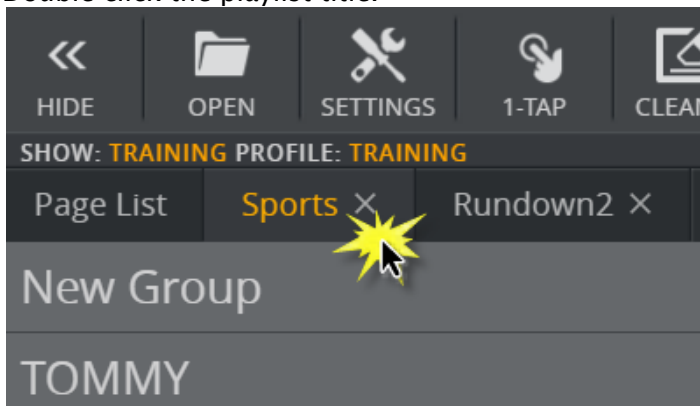

- The title field becomes editable.

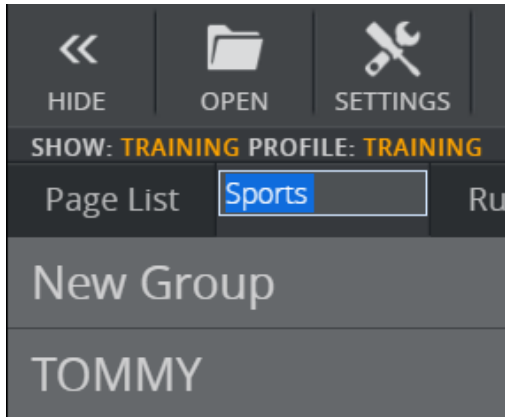

- Enter a new title in the field and press **ENTER** to confirm.

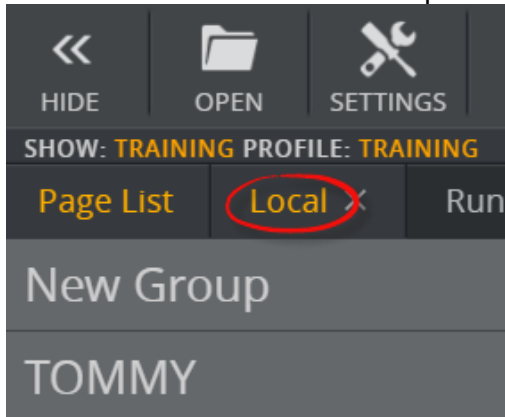

## Re-position a Playlist

- Click and drag the playlist to the desired position in the top menu.

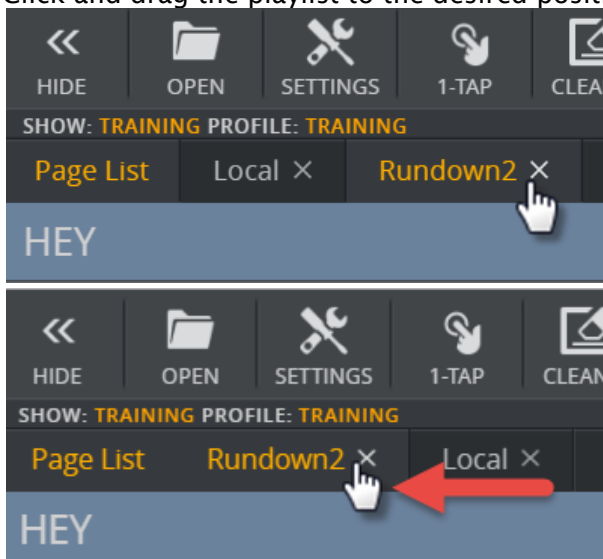

## 3.15 The Sources Pane

Use the Sources Pane to find media for your show:

- **Media Tab:** Search for assets in specified search providers.
- **Inbox Tab:** Content that is always available, across all shows.
- **GFX Tab:** Graphical elements to be used in your show.
- **Video Walls Tab:** Presets for Superchannel-based video walls.
- **Dynamic Walls Tab:** Presets for DynamicChannels based video walls.
- **Templates Tab:** Viz Pilot templates and elements.

**Note:** The **Show/Hide** button on the **Toolbar** allows you to **Hide Sources Pane and Show pane**.

### 3.15.1 Media Tab

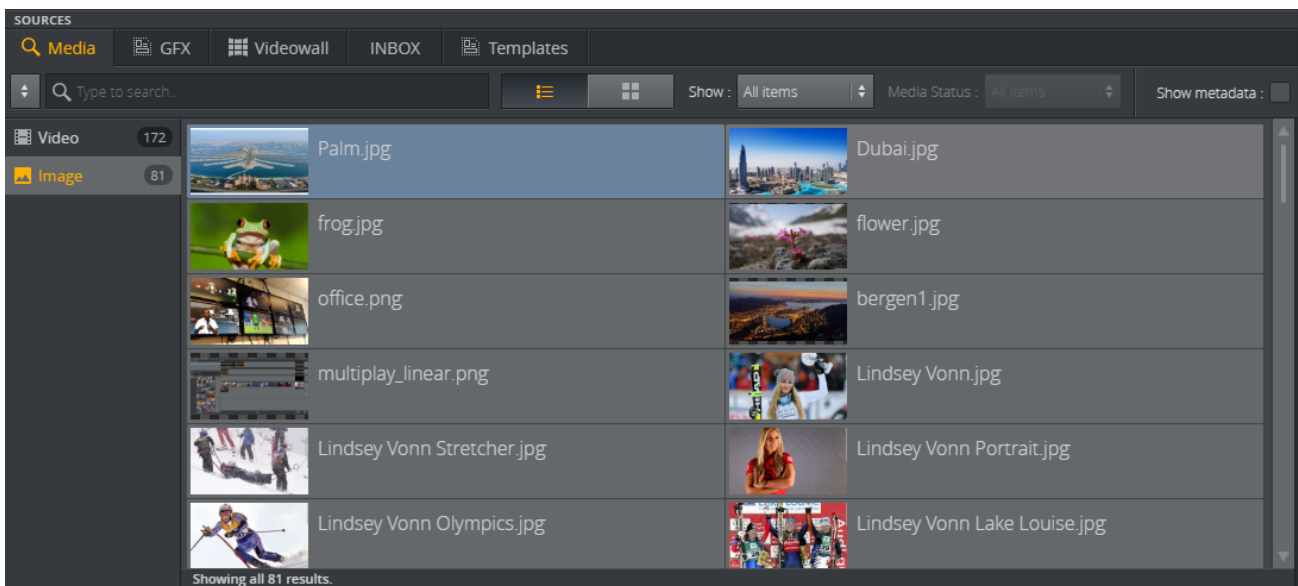

**Note:** Before using the Media Tab, make sure your search providers have been configured in **Settings > Servers Tab**.

In the Media tab, you can search for video and images in any of the search providers you have connected to, including Preview Server, Viz One, Pilot Data Server, Media Service and Graphic Hub. Once the element is found, drag it from the **Media Tab** to your channels.

#### Add Items to Channels from the Media Tab

Drag individual items or groups of items into channels from the Media tab.

1. Click the Media tab.



2. Select a media type.
3. Drag an item into a channel.
4. Hold **CTRL** and click multiple items to drag them as a group into a channel.

## Media Search Filters

**Note:** Not all search criteria are supported for all search providers; unsupported criteria are hidden if unavailable.

- **Keyword search:** Searches descriptions

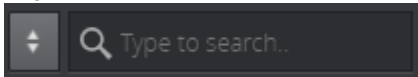

- **Media type:** Video or Image

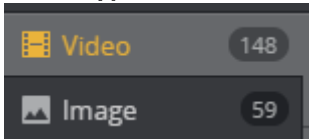

- **Date range:** Filter by date. All items, Last hour, Last day, Last week, Last month. Works with media from Viz One, Media Service, Pilot Data Server.

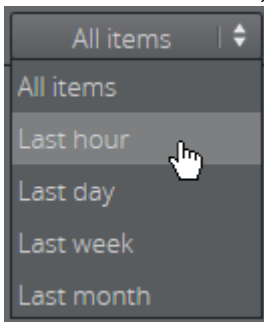

- **Tags:** Works with media from Pilot Data Server and Viz One. Only one tag can be selected at a time.

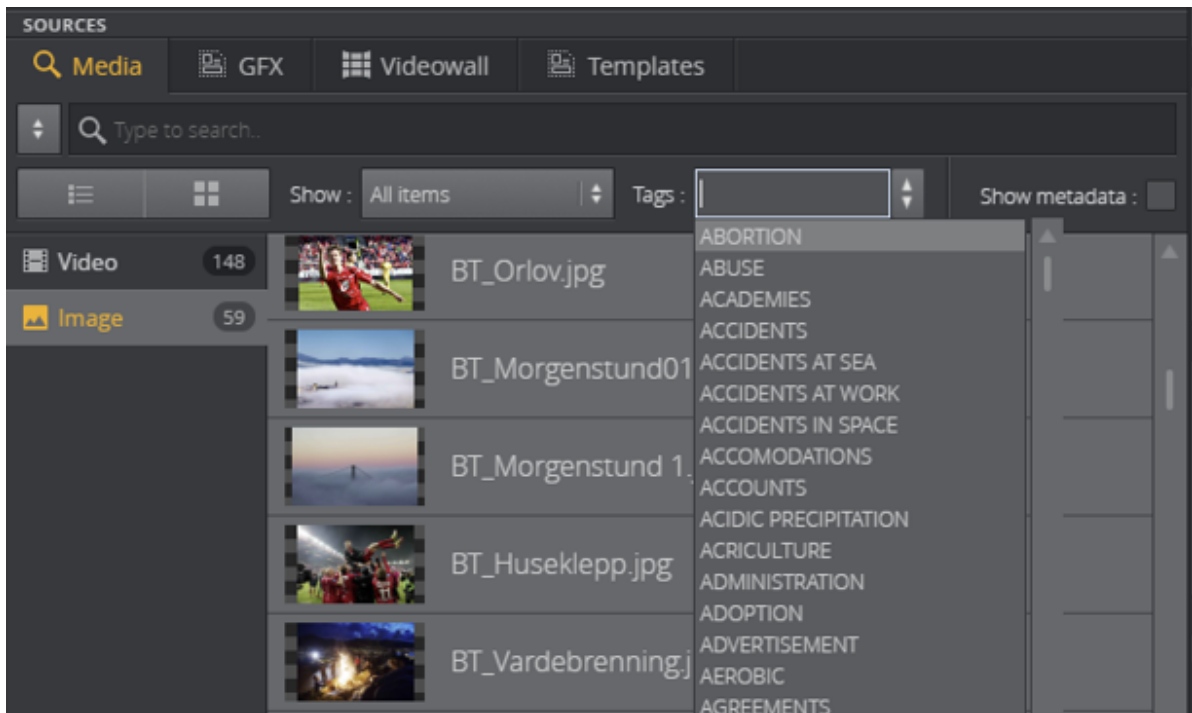

- **Search Provider:** Select media sources for your search (Pilot Data Server, Media Service, Viz One, Graphic Hub and Graphic Hub: default folder).

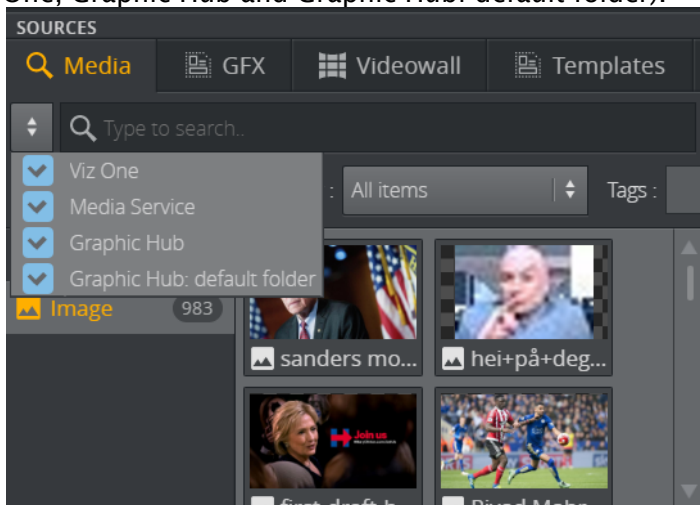

**Note:** Graphic Hub REST service versions higher than 2.0.1 support **Graphic Hub: default folder** as a search provider, in addition to **Graphic Hub**. The default folder only contains images ingested through the Graphic Hub REST API, while the **Graphic Hub** search provider exposes the full content of the Graphic Hub.

**Note:** **Viz One** items marked as **Blocked** in the MAM system appear in search results with a visual mark. They are not usable in Viz Multiplay until they are unblocked in Viz one.

## Video Preview

To preview a video, right-click an item and select **Preview**.

Videos can be edited once they have been added to channels, see [Editing Videos](#).

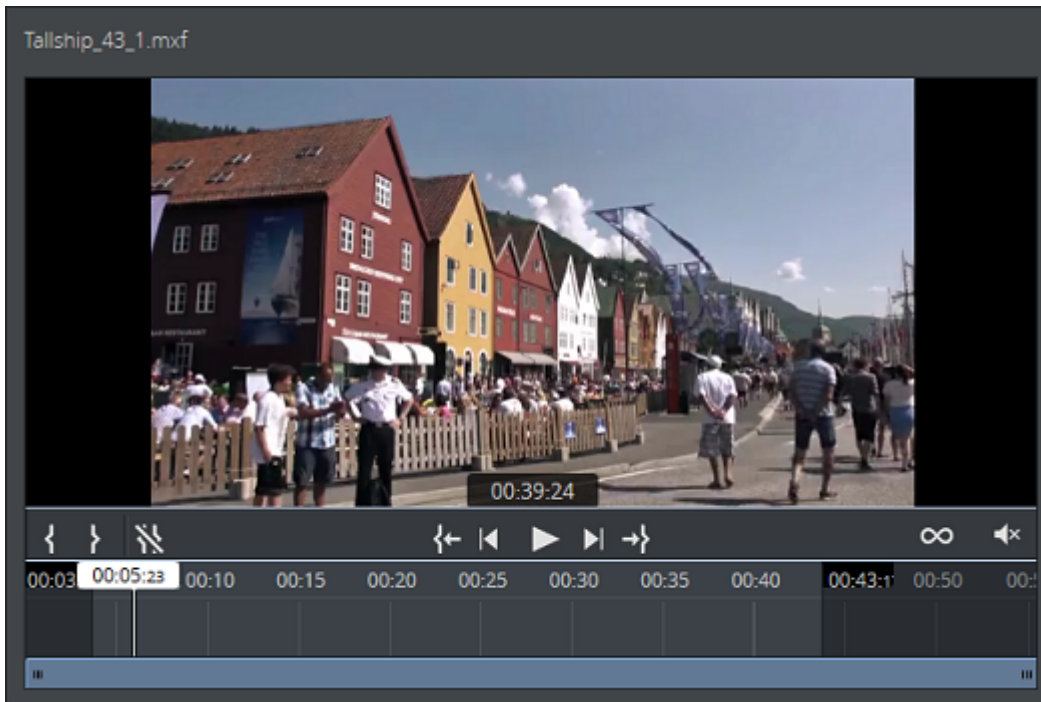

### 3.15.2 Inbox Tab

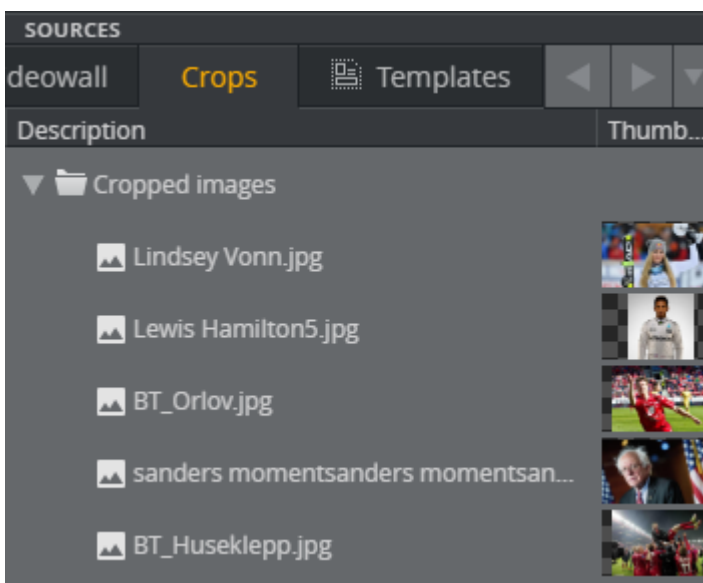

Users can work together to find and collect elements that can be easily added to a story. An inbox is global, meaning that it is available regardless of what show is currently open.

- Mark a show as an inbox by selecting it in **Settings > Inboxes Tab**.

Any content added to the show (eg. *Crops*) is immediately available in the Inbox tab. Elements can be dragged from the Inbox tab to a channel.

**Note:** When an element is dragged from the inbox to a channel in a show, it's copied, not referenced; this creates two separate elements that can be modified independently of each other.

**Note:** There are several ways to ingest elements into an inbox dynamically - for instance through the Media Sequencer REST API.

### 3.15.3 GFX Tab

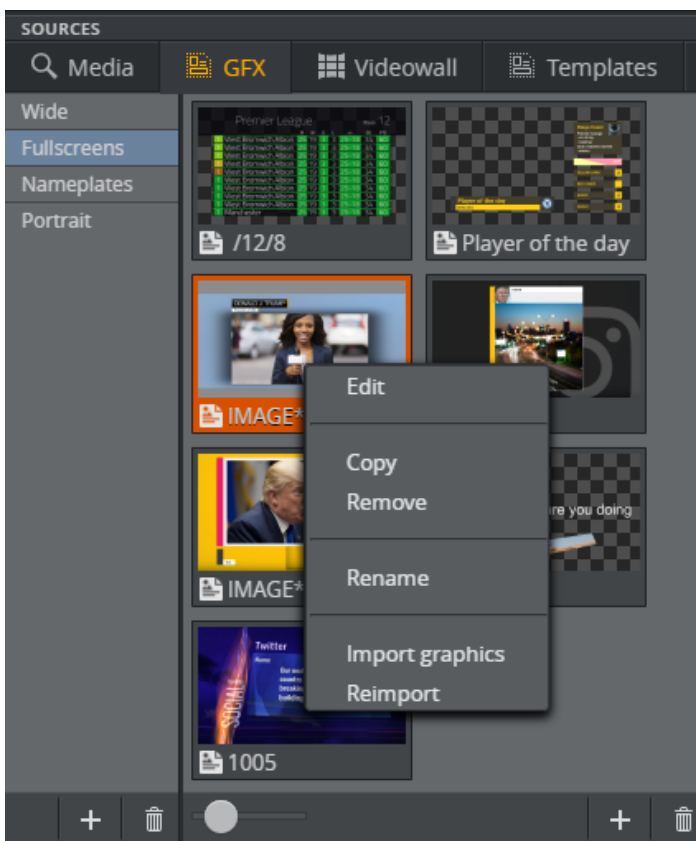

The GFX tab is a playlist within the show populated by importing Viz Artist scenes directly from the Graphic Hub or by using Viz Trio or the REST API of the Media Sequencer. You can also drag or copy and paste elements from a channel into a group in the GFX tab.

**Note:** The content from the GFX playlist is only available within the show in which the playlist is created. A playlist is set as the GFX tab by selecting it in **Settings > General Tab > Graphics**.

The graphical elements can be empty templates or filled with content and can be edited once they have been added to a channel, see [Editing Graphics](#). Any changes made inside an element are visible immediately.

## The Context Menu

Right-clicking an element in the GFX tab open the menu, which includes the following option:

- **Reimport:** Re-imports the graphics from the Graphic Hub. This is useful if the graphics designer has added or removed control fields.

## Changing Thumbnail Size and Aspect Ratio

- Drag the slider right to view bigger thumbnails and left to view smaller thumbnails.



The thumbnails for each group in the GFX tab can have different aspect ratios. This is handy if you have wide scenes or portrait scenes meant for playout in GFX channels with the same aspect ratio.

- Right-click a group in the GFX tab.
- Select **Set Aspect Ratio**.
- Choose an aspect ratio or select **Custom**.

- In the custom box - enter a numeric value (width divided by height).

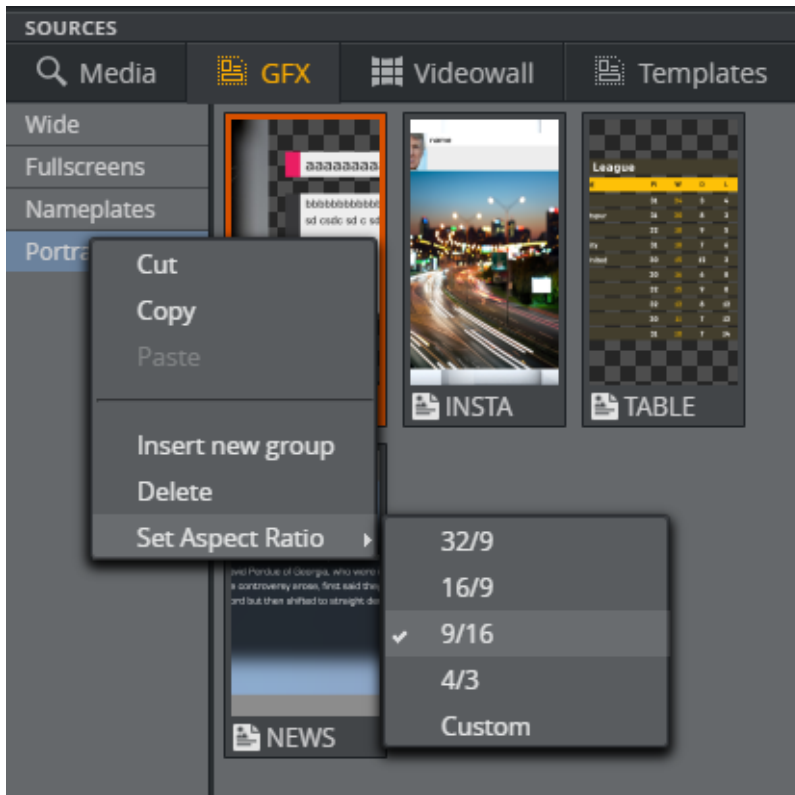

### 3.15.4 Video Walls Tab

The Video Walls Tab contains the Superchannel based video walls imported from the profile.

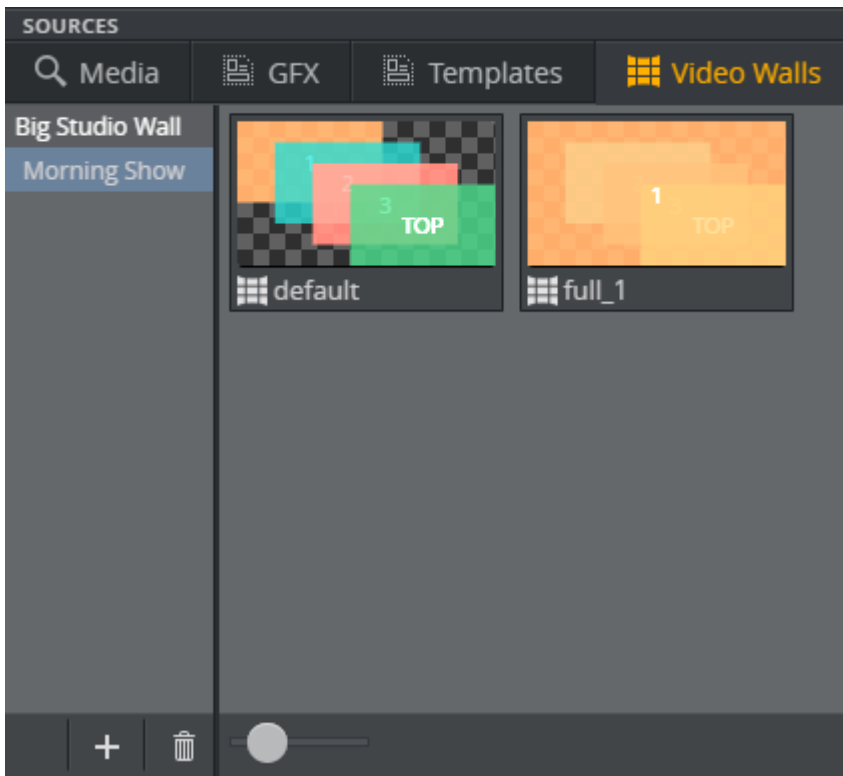

Click the **Plus** button to import new walls or new sets of presets (preset scenes) for a video wall into the current show. One video wall can have multiple sets of presets imported into the show.

If a set of presets has a yellow triangle next to it - it indicates that the presets have changed on the Graphic Hub - and they need to be reloaded. Right click and select **Reimport** to import the latest preset data from the Graphic Hub. **Check for updates** will check whether the presets on the Graphic Hub are updated since last import - for instance if a designer has modified the preset scene in Viz Artist.

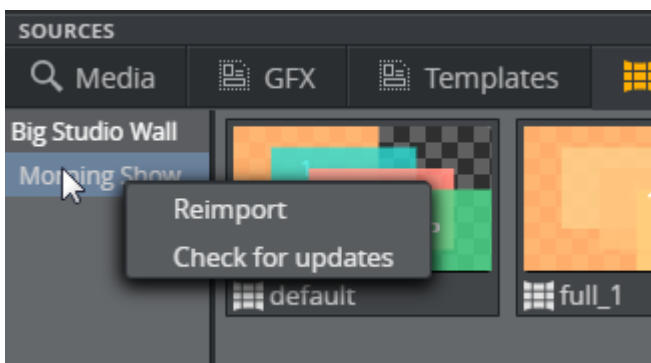

### 3.15.5 Dynamic Walls Tab

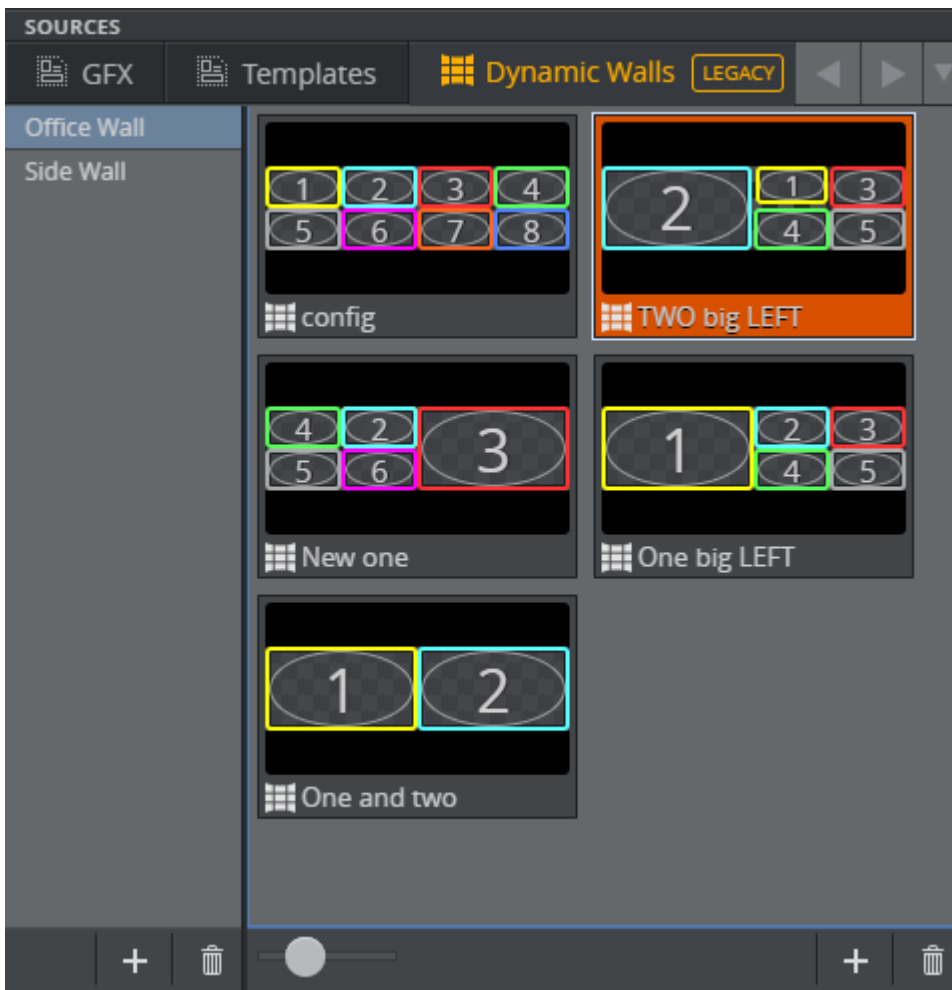

The Videowall tab contains the video walls created with the DynamicChannels solution in Viz Multiplay. The tab displays a regular playlist within the show that contains a set of [Presets](#) (video wall layouts). The content from this playlist is only available within the show in which the playlist is created.

- Set a playlist as the Videowall tab by selecting it in **Settings > General Tab > Videowall**.

The presets can be empty video wall layouts, or can be filled with content (media and scenes). The elements can be edited once they have been added to a channel (see [Editing Presets](#)). Any changes made inside an element are visible immediately.



## Viewing Elements in the Videowall Tab

- Drag the slider to adjust the size of presets:



## Connect a Videowall Group to a Videowall

Play out all the presets in a group on a specific videowall.

- ✓ **Tip:** Create one group for each videowall in a profile.

1. Right-click a group in the **Videowall** tab.
2. Select the desired videowall together with its main channel (the Viz output on which the videowall presets are run).

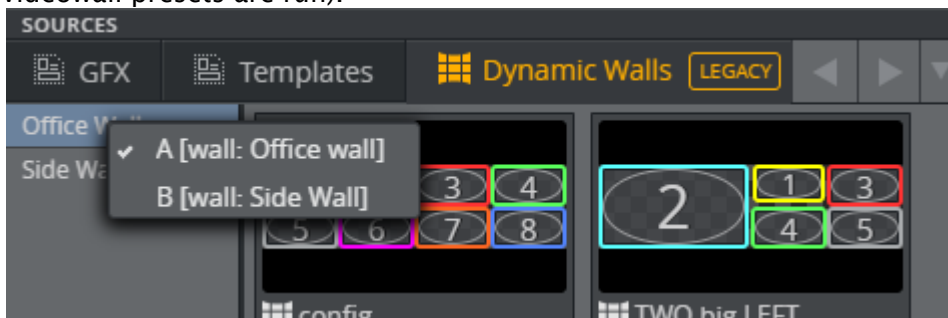

3. This group now only contains presets assigned to the selected videowall.

### 3.15.6 Templates Tab

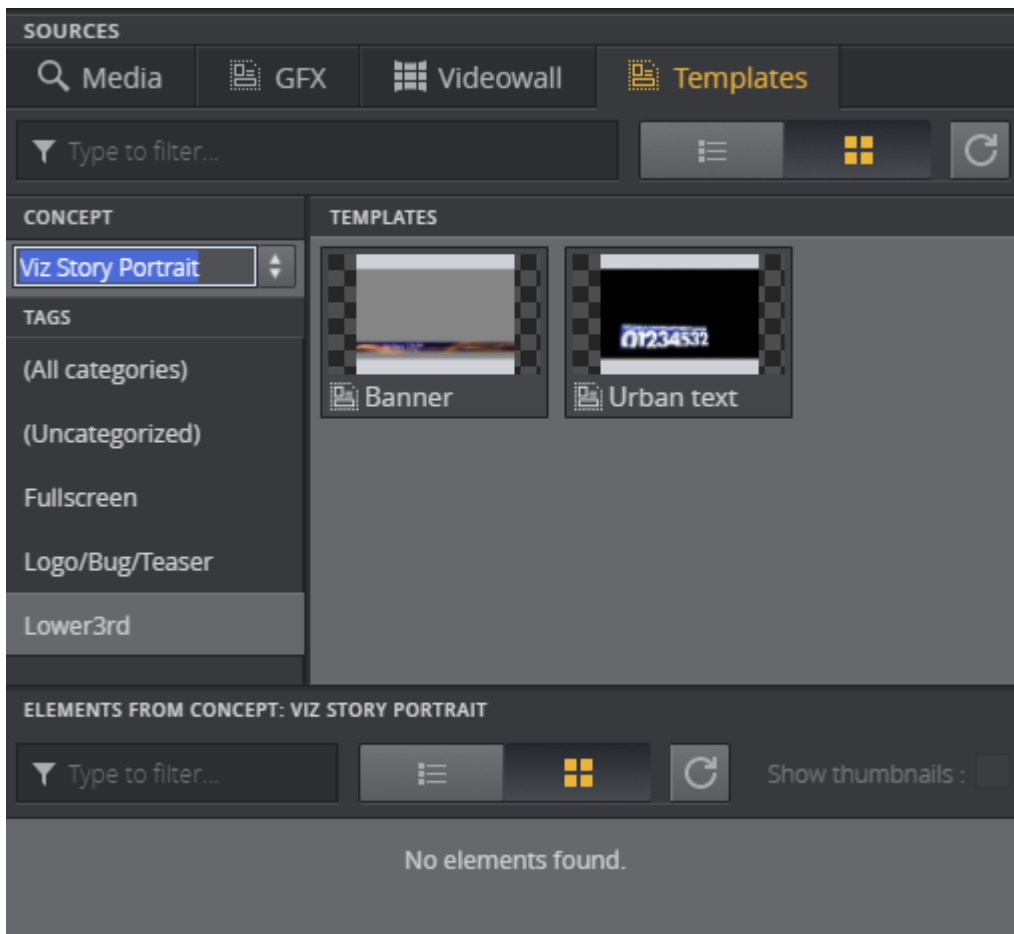

The Templates tab gives you access to **Viz Pilot templates** and elements.

**Note:** In order to access the Templates Tab, Viz Pilot must be configured as a search provider in **Settings > Servers Tab**.

Browse for a Viz Pilot template or an element. Right-click and select **Preview** to preview the graphics in a higher resolution.

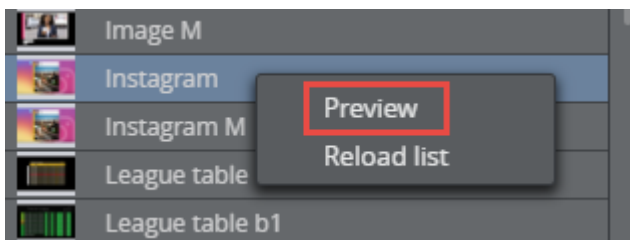

Drag templates directly into your channels. This will automatically create a new Viz Pilot element.

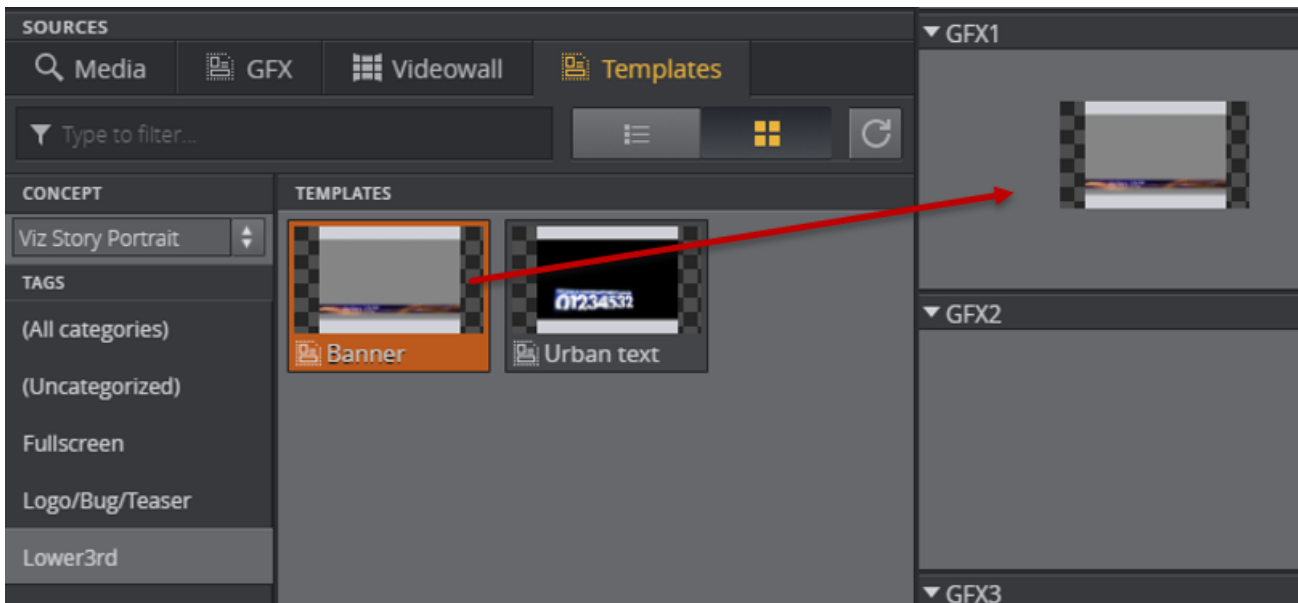

The templates can be edited once they have been added to a channel (see [Editing Graphics](#)). Any changes made inside an element are visible immediately.

## Working with Data Elements

Drag data elements from the Templates Tab into channels in the [Media Column](#).

This section covers:

- [What are Data Elements?](#)
- [Where Can I Find Data Elements?](#)
- [Refreshing the Data Elements List](#)
- [Filtering Data Elements](#)

## What are Data Elements?

Data elements are variations of a template.

For example, the same lower third may be used in both the morning and evening shows. Two different elements are created from a single template, each containing styling specific to the show for which it is created. The morning show element has a green lower third, while the evening show element has a red lower third.

## Where Can I Find Data Elements?

Elements are accessible at the bottom of the templates tab. Drag them into channels in the same way as templates.

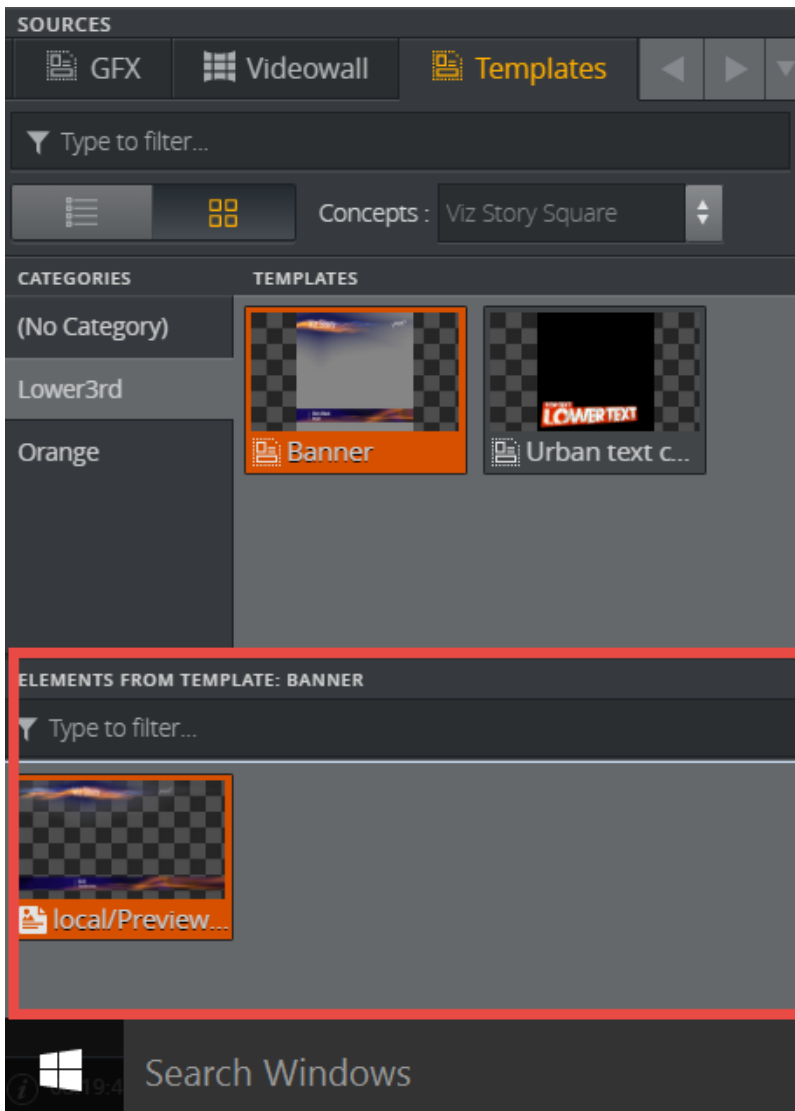

## Refreshing the Data Elements List

The data elements list is read out from the Pilot Data Server when a concept or a template is selected. This list does not change, even if someone is changing the list on the server. The list must therefore be refreshed manually.

### Refresh the List

1. Right-click an element in the data elements list.

2. Click **Reload list**.

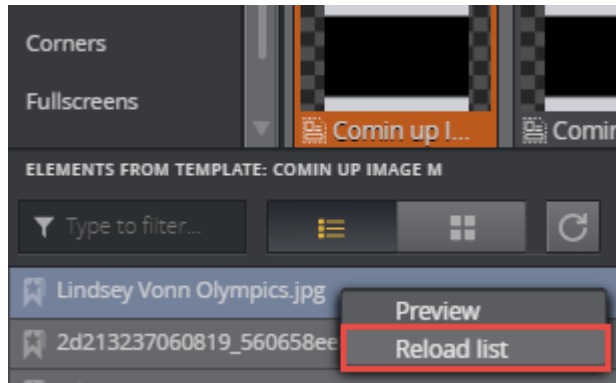

The current subset of data elements is reloaded from the server.

## Filtering Data Elements

Multiplay groups elements by concept and template.

**Note:** It's not possible to filter data elements by category.

## View Elements by Concept

Show all data elements belonging to all templates in a concept.

1. In the **Templates** Tab, click the **Concepts** menu and select a concept.

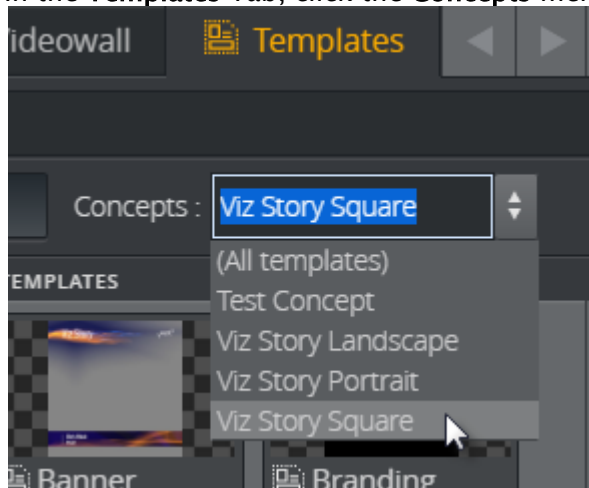

2. Both templates (1) and elements (2) for the selected concept are listed.

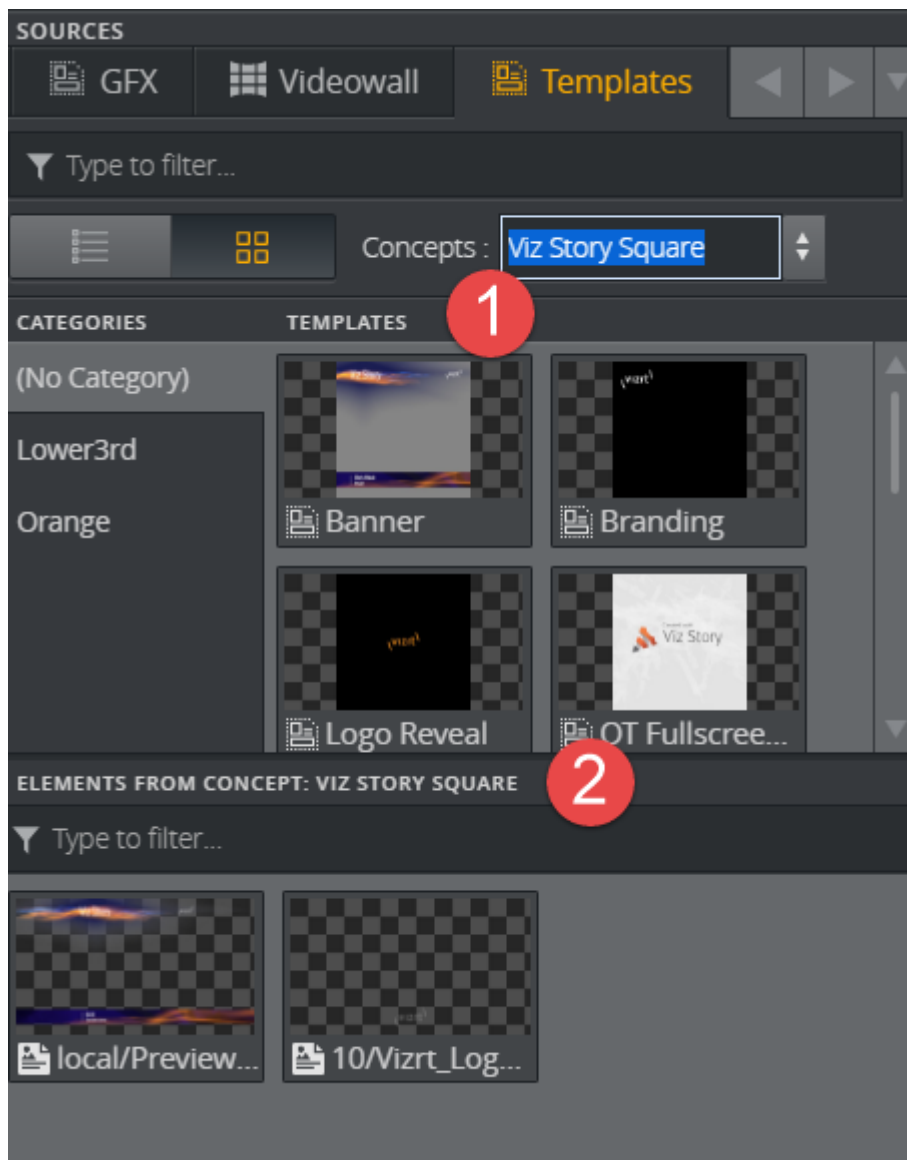

- ✓ **Tip: Elements from concept** is displayed to remind you that you are viewing elements associated with a concept.

## View Elements by Template

Show all data elements belonging to a specific template:

1. In the **Templates** Tab, click a template to view its elements.

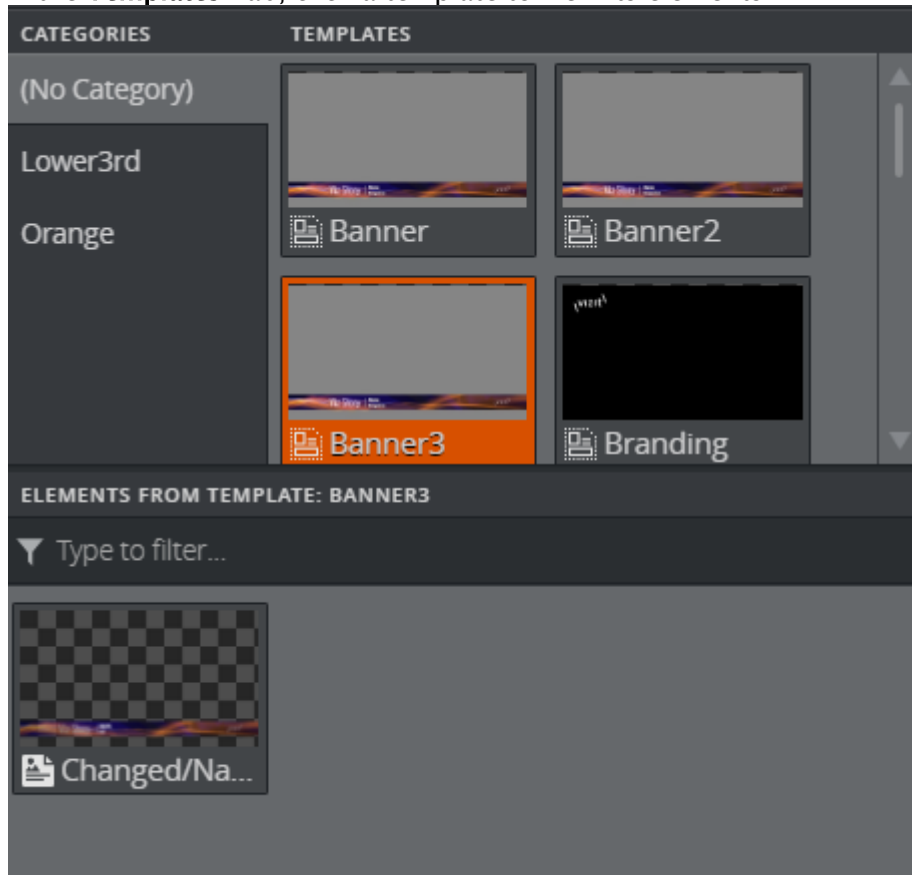

2. Here, **Banner3** contains a single element titled **Changed/Na...**

**Note:** Elements from template is displayed as a reminder that you are viewing elements associated with a single template.

## List and Grid View

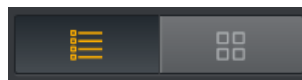

In the Templates Tab, click  to view elements and templates in list or grid view.

## 3.16 Using Shortcuts

The Shortcuts Bar gives fast access to frequently used elements, such as scenes, backgrounds or videos. In addition, video wall [Presets](#) can be selected and modified from the Shortcuts Bar.

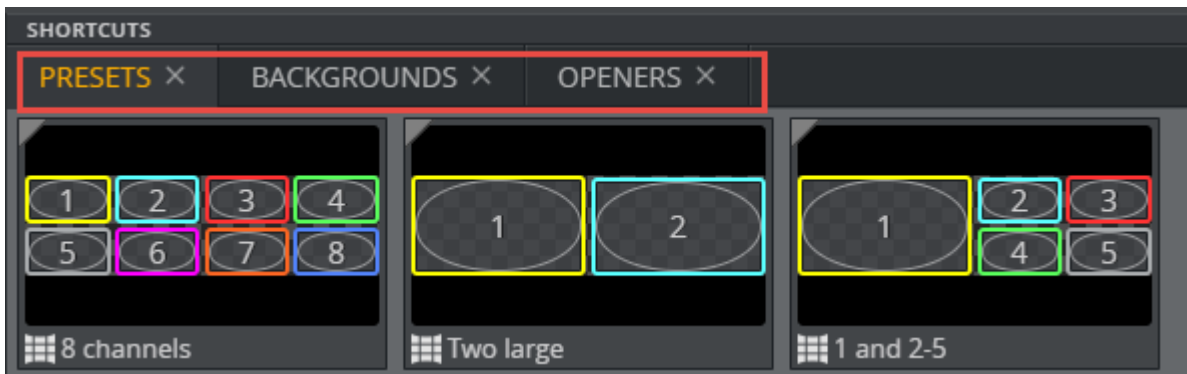

**Note:** The Shortcuts bar is actually a playlist within the show, so the content from this playlist is only available within the show in which the playlist is created.

A playlist is set as the Shortcuts bar by selecting it in **Settings > General Tab > Shortcuts**.

You can have **multiple tabs** of shortcuts to make it easy to access items that are used frequently, independent of which story you are working on. Each group in the Shortcuts bar playlist appears as a tab in the Shortcuts bar. The shortcuts are specific to a show so that when you change your show you can have different shortcuts for different productions.

**Note:** It's also possible to have shortcuts tab per workspace. This means that two workspaces can have different shortcuts. See [Configuring Workspaces](#).

This section covers:

- [Elements in the Shortcuts Bar](#)
- [Layers](#)
- [Working with the Shortcuts Bar](#)
- [GFX Preset Mode](#)

### 3.16.1 Elements in the Shortcuts Bar

- **Presets:** [Presets](#) define the layout of the channels on a video wall. When a new preset is taken to air, it triggers a transition from the current layout to the new layout. New presets are created using the [Video Wall Designer](#).
- **Filled Presets:** A [Filled Preset](#) is a preset which also includes content. When a filled preset is taken to air, it populates the preset with content and plays out everything at once. Presets are filled with content using the preset content editor.

**Note:** If a video wall group is partly filled, the empty GFX channels will continue to contain the old content.



- **Backgrounds:** Basic elements which load different scenes into the back layer of the video wall Engine. They need to be pre-assigned to the right channel and the right Viz layer so that they run in the back layer (this can also be set in the scene in its control object plugin).
- **Elements:** Images, videos and graphics.
- **Activate** the Shortcuts bar by selecting a Shortcuts Playlist in the **General Tab** of the Settings window.

Items in the Shortcuts Bar can be **armed** by clicking them, similar to arming channels.

## Shortcuts Bar Menu

Access two context menus by right-clicking elements in the Shortcuts Bar. The options in each menu change depending on the type of media you are right-clicking.

- [Shortcut menu for Presets](#)
- [Shortcut menu for Elements](#)

## Shortcut Menu for Presets

Right-click a preset in the Shortcuts Bar to expose the following context menu:

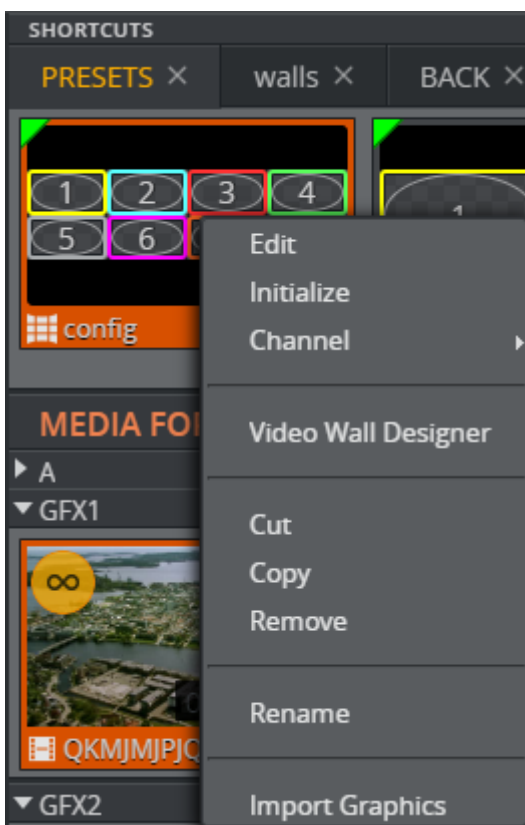

- **Edit:** Open the Preset Content Editor.
- **Initialize:** Load the preset scene on the renderer.
- **Channel:** Change the playout channel of the preset. The main renderer is normally called "A".
- **Video Wall Designer:** Open the [Video Wall Designer](#)

- **Cut** : Cut a preset and paste it in another tab/column.
- **Copy**: Copy a preset and paste it in another tab/column.
- **Paste**: Paste an element previously copied or cut.
- **Remove**: Remove the preset from the Shortcuts Bar.
- **Rename**: Rename the preset.
- **Import graphics**: Import graphics from the Graphic Hub directly into this group.

## Shortcut Menu for Elements

Right-click an element (video, image or graphic) in the Shortcuts bar to expose the following context menu:

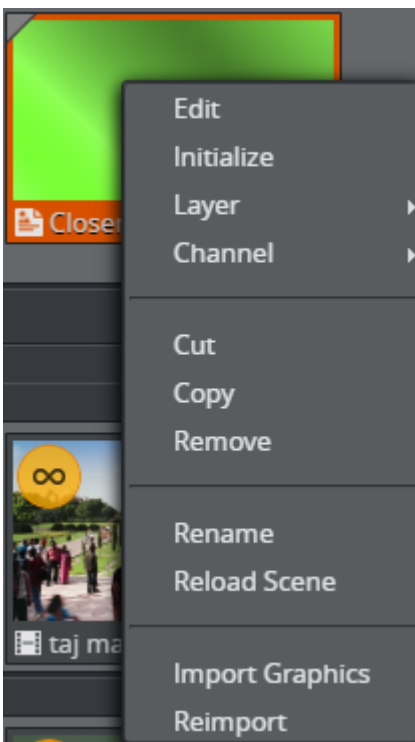

- **Edit**: Open the corresponding element editor.

**Note:** The image editor is only available for images assigned to a GFX channel.

- **Initialize**: Load the resources for this element into the renderer. Should be used with care. It may affect renderer performance.
- **Layer** : Change the Viz Engine layer (BACK, MAIN, FRONT). See [Layers](#).
- **Channel**: Change the playout channel of the element
- **Cut**: Cut a preset and paste it in another tab/column.
- **Copy**: Copy a preset and paste it in another tab/column.
- **Remove**: Remove the element from the Shortcuts Bar.
- **Rename**: Rename the element.
- **Reload Scene** (only for graphics): Makes the renderer reload the scene from the Graphics Hub.

- **Import graphics:** Import graphics from the Graphic Hub directly into this group.
- **Reimport** (only for graphics): Re-import the graphics from the Graphic Hub. Does not affect the renderer. Useful if the scene designer has added or removed control fields.

### 3.16.2 Layers

Use different layers to show up to three elements on screen simultaneously. Play elements in the default, FRONT, MAIN and BACK layers (defined below).

The selected layer will determine the element's position (whether or not it's visible) in relation to other elements.

✓ **Tip:** Set layers in the [Shortcut menu for element](#).

- **default:** Revert to the layer that is set by the scene designer.
- **FRONT:** Front layer elements cover main and back layer elements, i.e. this layer will never be obstructed.
- **MAIN:** The middle layer where elements cover back layer elements.
- **BACK:** The first layer than be used as a background for a videowall. Front and back layer elements will overlap it.

### 3.16.3 Working with the Shortcuts Bar

This section covers:

- [Add a shortcuts group](#)
- [Delete a group from the shortcuts bar](#)
- [Rename a group](#)
- [Re-position a group in the Shortcuts Bar](#)

#### Add a Shortcuts Group

Add a group to the playlist you have chosen to appear in the shortcuts bar. Groups created via the shortcuts bar appear in the show pane when no shortcut playlist is set.

1. Click the **Add (+)** button in the Shortcuts Bar.

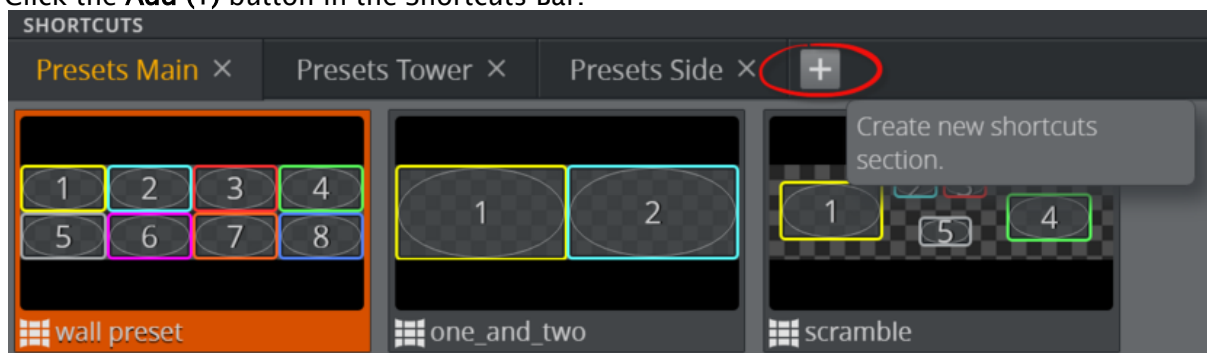

2. Give the new group a title.
3. Click **OK**.

## Delete a Group from the Shortcuts Bar

Delete playlist groups from the shortcuts bar.

1. Click the close button in the top right corner of the shortcut group tab.

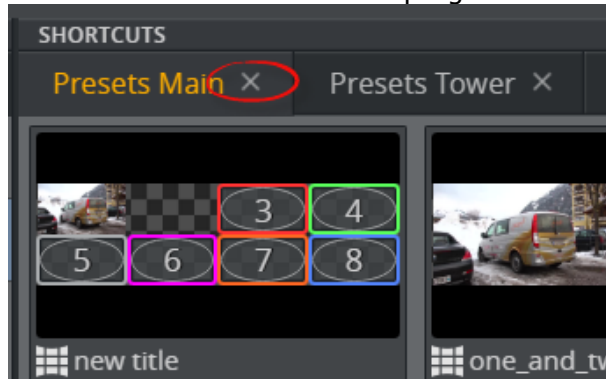

2. Click **Yes**.

## Rename a Group

1. Double-click the group's title.

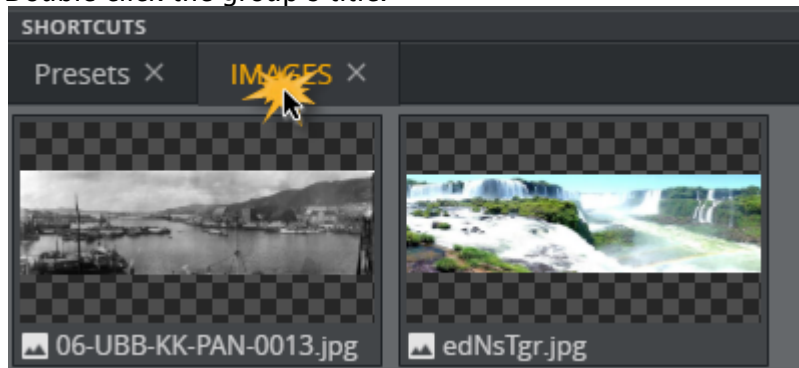

2. The title field becomes editable.
3. Enter a new title in the field and press **ENTER** to confirm the change.

## Re-position a Group in the Shortcuts Bar

1. Click and drag the group to the desired position in the top groups.

### 3.16.4 GFX Preset Mode

GFX preset mode the exposes a filled preset's main and graphics (GFX) channels by pressing **SHIFT**.

The following sections cover the GFX preset mode and its advantages, and present a GFX preset mode workflow example:

- [Two Modes](#)
- [How Do I Activate GFX Preset Mode?](#)
- [Workflow Example](#)

## Two Modes

The shortcuts bar has two modes: thumbnail mode and graphics (GFX) preset mode. By default, the shortcut bar is in thumbnail mode. This means only item thumbnails in a preset will show in the program (on-air) column, as shown here:

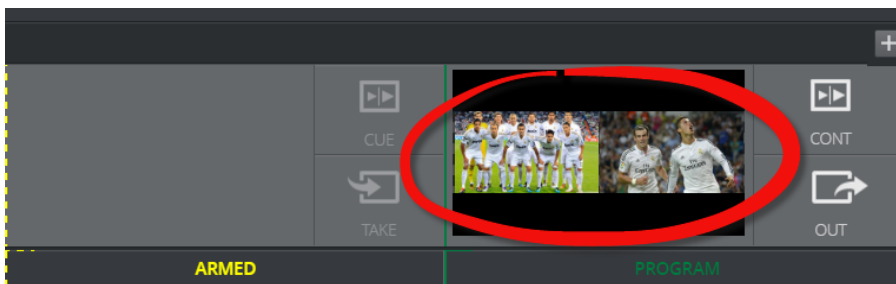

You may, however, need to know the following:

- Which main channel your presets are playing out on; and
- Which GFX channel an item in a preset is playing out on.

This information is available in GFX preset mode, which provides:

- A visual confirmation that presets are being sent to the desired wall; and
- Assistance when replacing content in a GFX channel.

## How Do I Activate GFX Preset Mode?

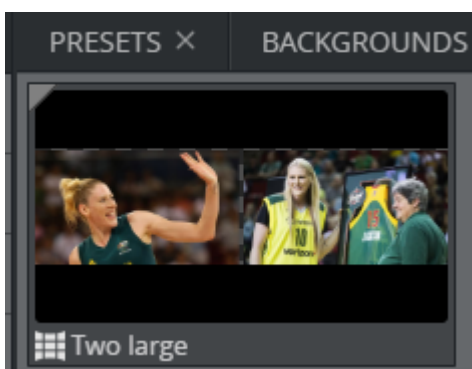

Press **SHIFT** when Multiplay is in focus. Once GFX preset mode is activated, small green icons appear in the bottom corner of a preset or item thumbnail showing the main channel the GFX channel number:

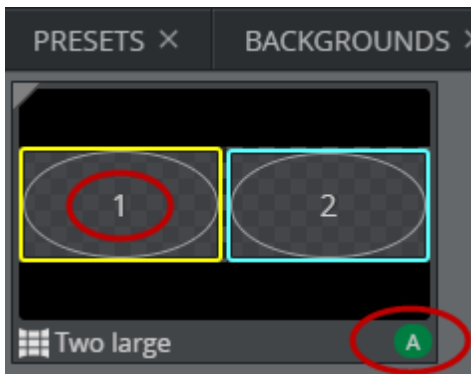

**Note:** These icons only appear for items and presets in the shortcuts bar.

### Workflow Example

In this workflow, activate GFX preset mode to see which GFX channel hosts a picture you want to replace.

1. Take a filled preset to air from the shortcuts bar.
  - a. Click the preset to move it to the Armed column.
  - b. Click it in the Armed column to move it to the Program column.



2. By default the thumbnails appear in the preset in the program column, and there is no visual indication which GFX channel they are playing out on.

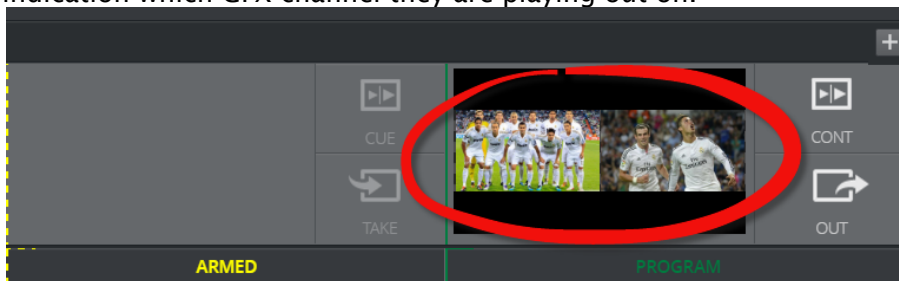

3. Press and hold **SHIFT** to see the preset's main and GFX channels. The thumbnails are replaced with the GFX channel number. This preset is playing out on wall A and has images in GFX1 and GFX2.

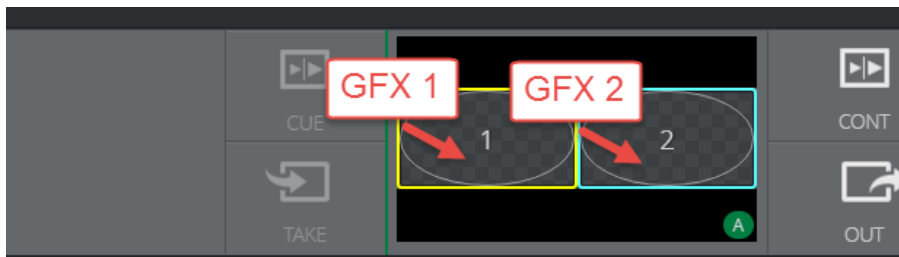

4. Now, if you want to replace the team photo with another image, you know you must replace the photo in GFX1.
5. Drag an image from any channel into GFX's program channel.

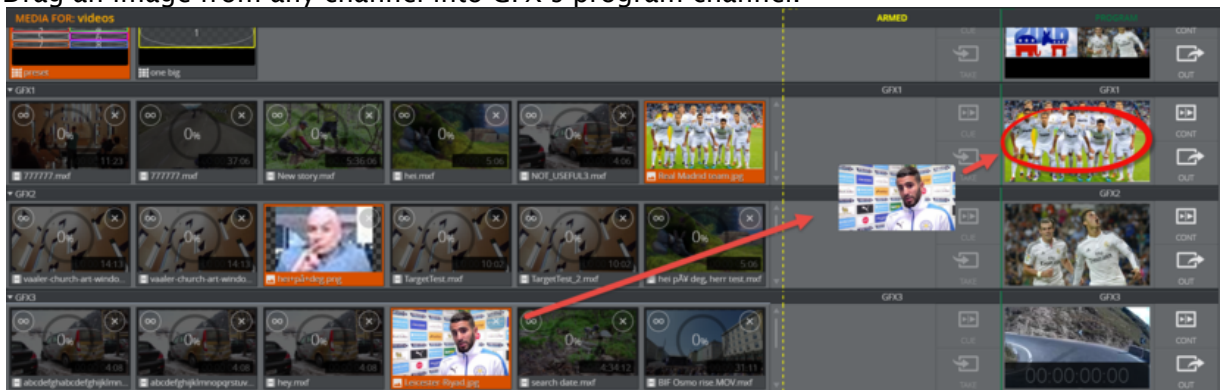

✓ **Tip:** Drag an image into a program channel from any channel. This means that the image in the program column for a certain GFX channel can be exchanged with an image from any other channel.

⚠ **Important!** The new image does not appear in the Filled Preset in the shortcuts bar. A video wall set up is required to see it live On Air in the filled preset.

## See Also

- [Presets](#)

## 4 The User Interface

This section describes how to work with Viz Multiplay:

- [Overview of the Interface](#)
- [Status and Logs](#)
- [Keyboard Shortcuts](#)
- [Video Wall Designer](#)

### 4.1 Overview Of The Interface

Once a show is selected using the **Open** button, the Viz Multiplay window displays the following areas:

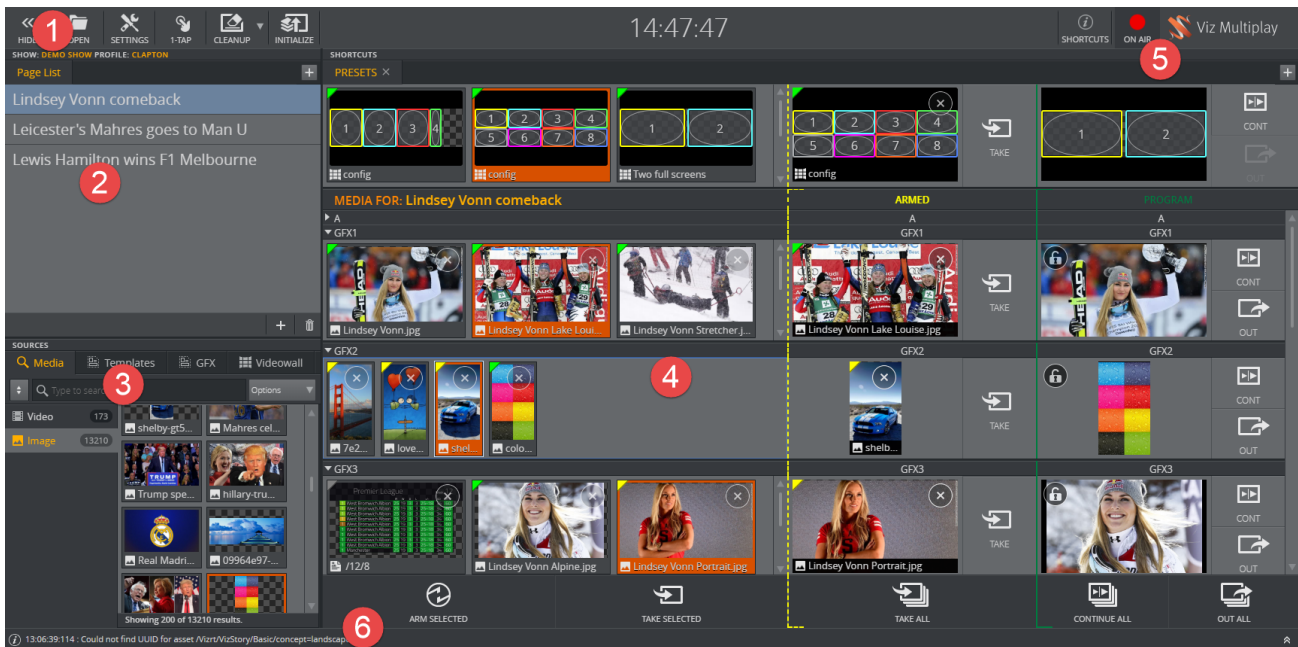

The window contains the following main areas:

1. [Toolbar](#)
2. [Show Pane](#)
3. [The Sources Pane](#), which includes:
  - [Media Tab](#)
  - [Inbox Tab](#)
  - [GFX Tab](#)
  - [Videowall Tab](#)
  - [Templates Tab](#)
4. [Media Pane](#), which includes
  - [Using Shortcuts](#)
  - [Media Column](#)
  - [Armed column](#)
  - [Program column](#)



- [Action Bar](#)
- 5. [On Air Mode](#)
- 6. [Status Bar](#)

## 4.2 Status And Logs

### 4.2.1 Status Bar

Display the Status bar by selecting **Show status bar** in the [Settings](#) window.

When minimized the Status bar shows the latest status message.

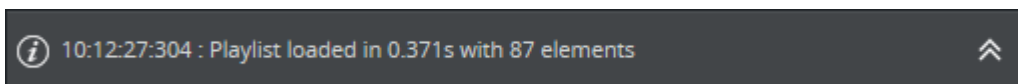

### 4.2.2 Logs

Click **Expand**  to show the Log Messages pane.

Message can be filtered by type (Messages, Warnings, Errors) or download them into a file using the **Save log** button. Logs can be deleted by clicking **Clear log** tab.

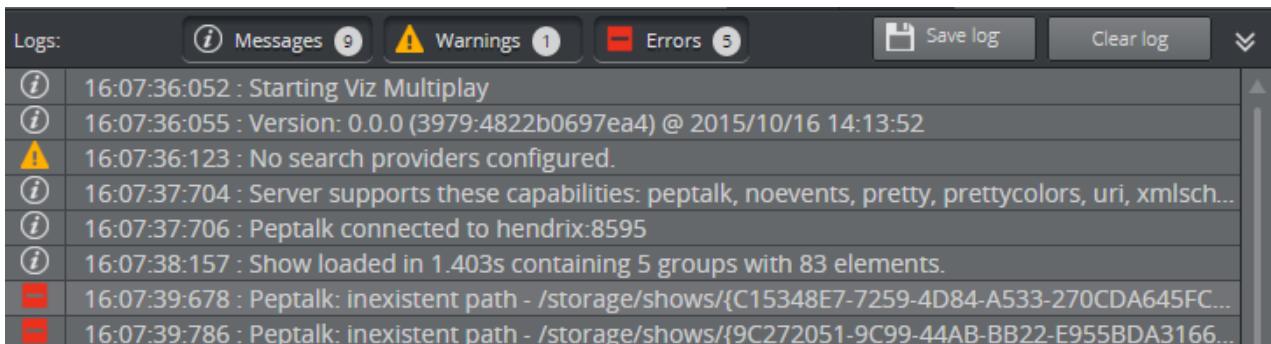

### 4.2.3 Version Information

Scroll to the beginning of the log messages to find the Viz Multiplay version information.

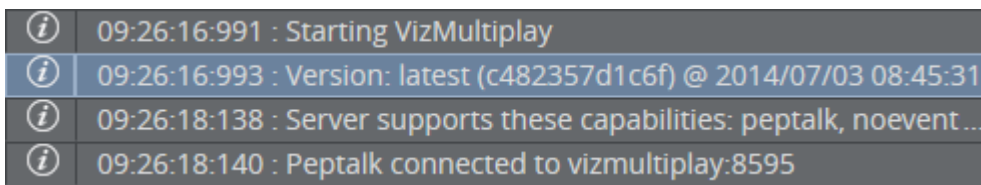

#### See Also

- [Troubleshooting and Known Issues](#)

## 4.3 Keyboard Shortcuts

There are different keyboard shortcuts available depending on where in Viz Multiplay you are.

The different areas where you can use keyboard shortcuts are:

- [Main Window](#)
- [Profile Configuration](#)
- [Video Editor](#)
- [Workspaces](#)
- [Video Wall Designer](#)

### 4.3.1 Main Window

Clicking this button will display a window with all the available keyboard shortcuts in the [Main Window](#) in Viz Multiplay:



Shortcut	Action	Comment
<b>A, [number]</b>	Arm on channel.	Arm the currently selected or first element on the channel.  If in 1-Tap mode, do nothing.
<b>T, [number]</b>	Take on channel.	If in 1-Tap mode, take the currently selected/first element on the channel.  If not in 1-Tap mode, take the armed element.
<b>C, [number]</b>	Cue armed element on channel.	Cue the currently armed element.  If in 1-Tap mode, do nothing.
<b>ALT + T</b>	Take all armed or selected elements.	Depends whether 1-Tap mode is enabled or not. If enabled, the key press will take all selected elements, and if not, all armed elements are taken.
<b>ALT + C</b>	Cue all armed elements.	

Shortcut	Action	Comment
<b>ALT + U</b>	Unarm all armed elements.	
<b>P, [number]</b>	Continue current element on channel.	Continue the currently running element(s).
<b>O, [number]</b>	Out the current element on channel.	Take OUT the currently running element(s).
<b>ALT + P</b>	Continue all elements in the Program channel.	
<b>ALT + O</b>	Out all elements in the Program channel.	
<b>SHIFT + R, [number]</b>	Re-Cue the current video on channel.	Re-cue the video element currently set on the channel.
<b>SHIFT + P, [number]</b>	Pause the current video on channel.	Pause the currently playing video on the channel.
<b>SHIFT + V, [number]</b>	Play the current video on channel.	Play/continue the currently cued/paused video on the channel.
<b>SHIFT + C</b>	Collapse all channels.	
<b>SHIFT + E</b>	Expand all channels.	
<b>SHIFT</b>	Reveal channels.	Hold the <b>SHIFT</b> key to reveal more info on thumbnails in the Media Pane: GFX channels on filled presets, channel on shortcuts elements, and full description.
<b>ENTER</b>	Take or Arm the selected element.	
<b>DELETE</b>	Delete the selected item.	
<b>F2</b>	Rename group.	

The **[number]** in the above table refers to the index of the visible channels in the Multiplay GUI. The first visible channel has shortcut key 1, the second visible channel has shortcut key 2 etc. This means that if the GUI contains two channels A and B then A has shortcut key 1 and B has 2.

Note that [number] should be typed without any modifiers (**CTRL**, **SHIFT**, **ALT** etc.). If the combination is a key and a number, the key must be pressed and released followed by the number in two separate consecutive key presses - not a simultaneous key press combination.

### 4.3.2 Profile Configuration

The following keyboard shortcuts are related to the **Channels** list in the **Profiles** tab in **Settings**. Click a channel and apply the shortcuts to reorder channels.

Shortcut	Action
<b>CTRL + UP ARROW</b>	Move a channel up in the list.
<b>CTRL + DOWN ARROW</b>	Move a channel down in the list.

### 4.3.3 Video Editor

The following keyboard shortcuts are available when previewing a video from the [Video Editor](#) window:

Shortcut	Action
,	Move one frame back.
.	Move one frame forward.
<b>M</b>	Mute.
<b>I</b>	Mark In.
<b>O</b>	Mark Out.
<b>SHIFT + I</b>	Go to In point.
<b>SHIFT + O</b>	Go to Out point.
<b>SHIFT + C</b>	Clear In/Out points.
<b>J</b>	Fast reverse playback.
<b>K</b>	Pause.
<b>L</b>	Fast forward playback.
<b>SPACE</b> or <b>CTRL + SPACE</b>	Play/Pause.
<b>ALT + J</b>	Play backward at 0.5x speed.

Shortcut	Action
ALT + L	Play forward at 0.5x speed.
SHIFT + J	Move ten frames back.
SHIFT + L	Move ten frames forward.
SHIFT + K	Keyboard shortcuts.
Scroll wheel	Timeline zoom.

### 4.3.4 Workspaces

In the Workspace Settings, you can assign your own keyboard shortcuts to switch between workspaces. To assign shortcuts, see [Shortcuts per workspace](#).

### 4.3.5 Video Wall Designer

In the [Video Wall Designer](#), a help page for keyboard shortcuts is displayed when clicking the  button:

Shortcut	Action
ARROW KEYS	Move selection.
SHIFT + ARROW KEYS	Move selection more.
CTRL + resize	Keep the aspect ratio when scaling.
N	Enable/disable snap.
SPACE	Enable/disable the pan tool.
A	Enable/disable to keep the aspect ratio.
Z	Zoom in.
X	Zoom out.
CTRL + click	Select/deselect multiple options.
CTRL + ALT + click	Select behind current selection.
CTRL + F	Bring selection to the front.
CTRL+ B	Bring the selection to the back.
BACKSPACE or DELETE	Delete selected items.
CTRL + Z	Undo.

Shortcut	Action
CTRL + Y	Redo.
CTRL + S	Save changes.
CTRL + SHIFT + S	Save changes as.

## 4.4 Video Wall Designer

Use the Video Wall Designer to create and modify video wall presets. Each area in the designer represents a channel where content can be played out. Create the desired layout by moving, layering and resizing the channels.

### 4.4.1 Superchannels–based Video Walls

For the Superchannels-based video walls - the video wall designer is accessible from within the video wall in the profile. It is important to understand that a video wall layout (a set of presets) is represented by a Viz Artist scene. The video wall designer in this case represents all the presets inside the scene. A difference from previous behavior (using Dynamic Channels), is that pressing Save now will write the complete scene back to the Graphic Hub and a refresh of the renderer is needed. To open the Video Wall Designer:

1. Go to **Settings > Profiles**.
2. Click the profile containing the video wall to edit.
3. In the Video Wall manager, the different video walls and their associated Viz Artist scenes are now listed.
4. Right click a preset and select **Edit Preset**.

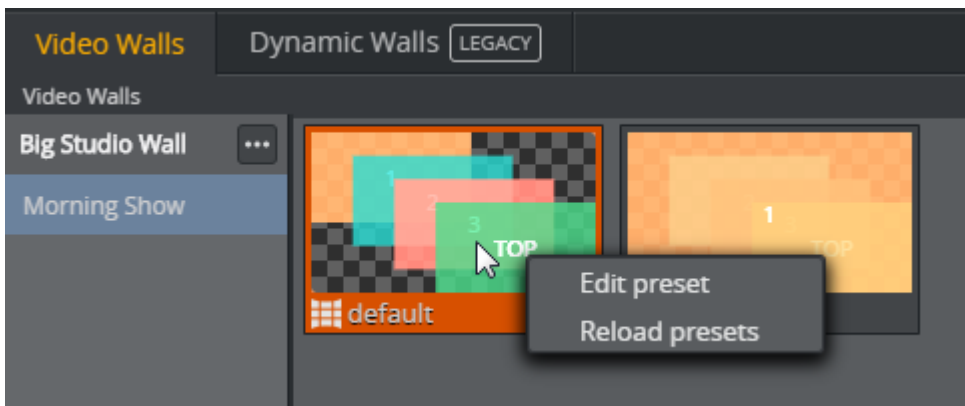

If the preset scene has changed (for instance when a designer changes the scene in Viz Artist), select **Reload presets** to display the latest changes.

### 4.4.2 Dynamic Channel–based Video Walls

There are two ways to open the Video Wall Designer using the DynamicChannels based video walls:

1. Right-click a preset in the Shortcuts Bar.

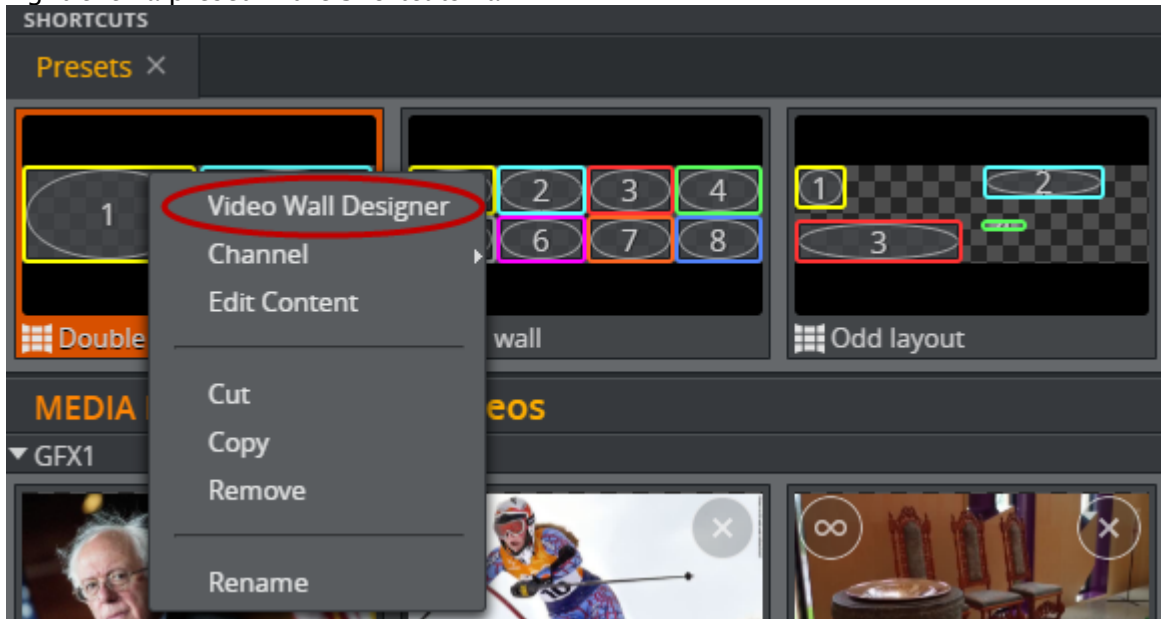

2. Right-click a preset in the Videowall Tab.

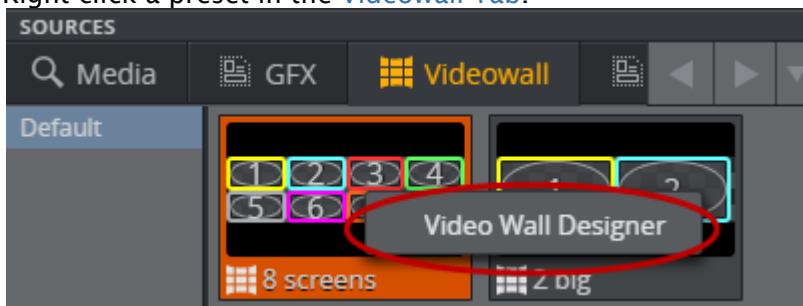

### 4.4.3 Video Wall Designer Layout

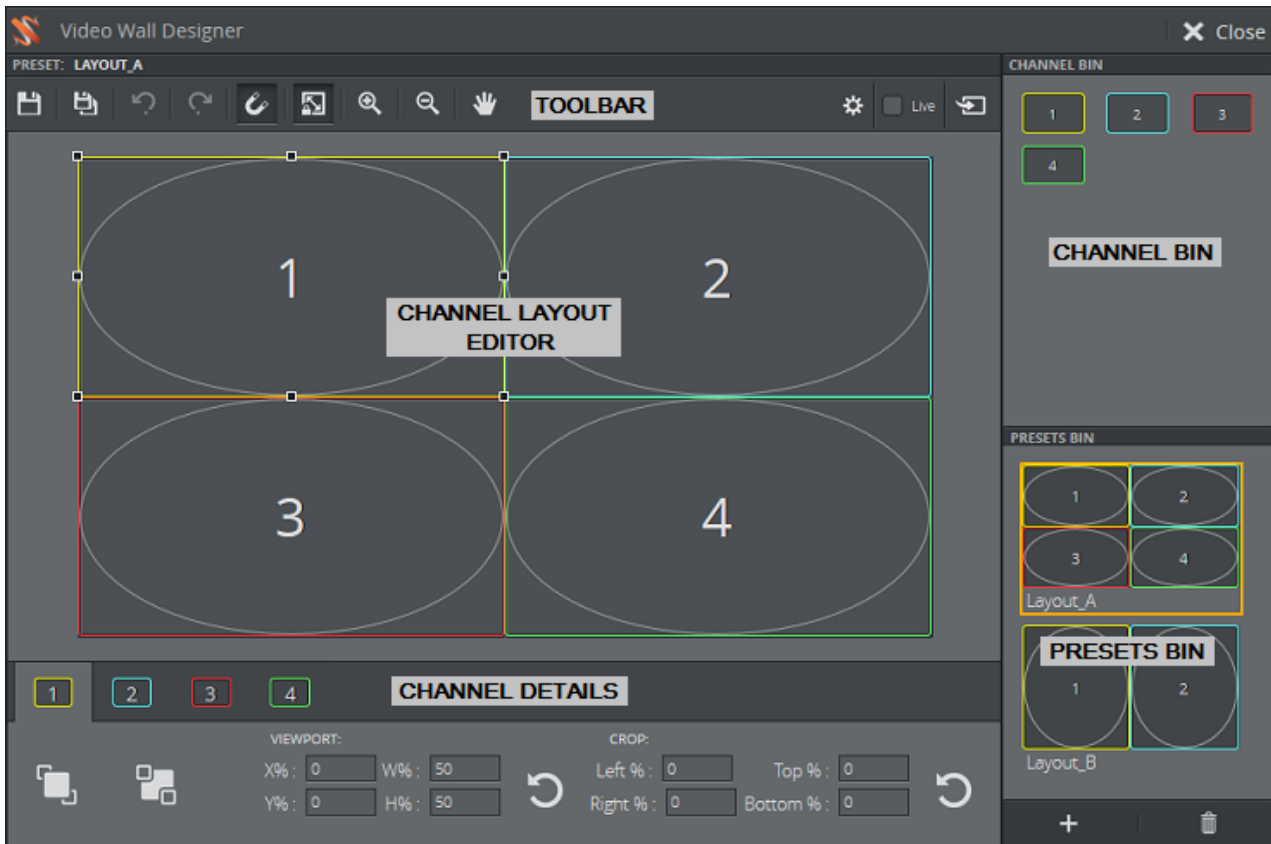

The Video Wall Designer is organized into the following areas:

- [Toolbar](#)
- [Channel Bin](#)
- [Presets Bin](#)
- [Channel Details](#)
- [Channel Layout Editor](#)

The backdrop of the Video Wall Designer layout is called the

- [Active Areas Editor](#)

#### Toolbar



#### Left Side:

- **Save:** Save changes to the current preset (DynamicChannels) or save the preset scene back to Graphic Hub (Superchannels).



- **Save As:** Save the layout as a new preset. Not available in Superchannels mode.
- **Undo/Redo:** Undo/redo last move.
- **Toggle snapping:** Snap to a grid, to the edges of Active Areas and GFX channels.
- **Number of snap points:** The number of snap points (grid) distributed across the underlying Active Areas (the snap areas). For instance: 4 snap points will make the GFX channel snap to the edges of the underlying Active Area, and 2 in between. Increasing the snap points will make the grid finer.
- **Keep aspect ratio:** Maintains aspect ratio of the channel when the frame is cropped or resized. Also enforce the aspect given for the channel in the Profile when the GFX channel is dragged from the Channel Bin or reset.
- **Zoom in/out:** Click to zoom in or out.
- **Center.** Center the view of the video wall area. (Hint: Use the scroll wheel to zoom in and out.)
- **Pan mode:** When Pan mode is *on*, pan by dragging the background or a channel. When Pan mode is *off*, you can still drag the background to pan, but dragging a channel moves the channel. Dragging a handle always moves the handle.

## Right Side

- **Active Areas editor mode:** Hides the GFX channels and makes the underlying Active Areas become editable. The Active Areas represents the physical dimensions of the screens in the video wall. The Active Areas are snap points to which the GFX channels will snap. See [Active Areas Editor](#).
- **Import Datapath configuration:** When the setup of the display controller hardware is done, the layout of the screens can be imported from the PC hosting the Datapath device. Only enabled in Active Areas editor mode.
- **Open Advanced Settings.**
- **Live:** When *Live* is checked, all changes done to the preset and Active Areas are taken on air immediately. This is useful while adjusting and testing video wall configurations.
- **Color Active Areas:** When adjusting the Active Areas and being in *Live mode*, the purpose is to create a backdrop in the Video Wall Designer that matches the physical screens. When adjusting this backdrop (the Active Areas) it is useful to fill the area with a color. When clicked - the selected Active Area will be drawn with a color on the renderer, so the area can be adjusted to whether it matches the physical screen. Only enabled in Active Areas editor mode. If not clicked - and being in *Live mode* the Active Areas will be filled with whatever content that is already played in the corresponding GFX channels.
- **Take Presets:** When the *Take* button is clicked, the current state of the preset, including any unsaved changes, is taken on air. This is useful while adjusting and testing video wall configurations.
- **i:** Opens the keyboard shortcuts window.

#### 4.4.4 Channel Bin

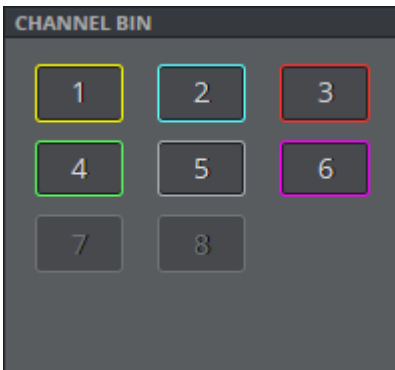

Click an item in the Channel Bin to turn it on or off in the [Channel Layout Editor](#). You can also drag channels from the Channel Bin to the video wall.

#### 4.4.5 Presets Bin



The Presets Bin lists the DynamicChannel presets which are available in the current preset group (DynamicChannels). The Preset Bin is not enabled in superchannels mode.

In the Presets Bin you can:

- **Add** or **delete** presets.
- Double click on the preset to **open** it in the editor.
- Double-click the name to **rename** it.

**Note:** If the preset or element is shown in a playlist in Viz Trio, the name given in Viz Multiplay will be shown in the *Description* column in Viz Trio.

## 4.4.6 Channel Details

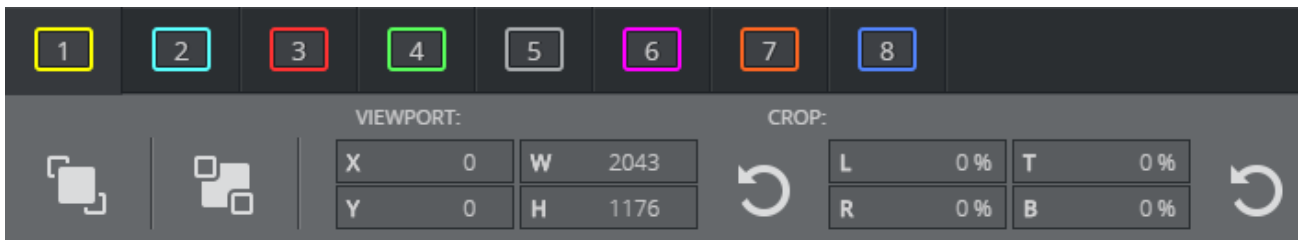

For each channel, you can modify the [Layer Order](#), [Viewport](#) and [Crop](#).

### Layer Order

- **Bring to front / Send to back:** Move the selected channel to the front or back. This changes the order in which items are layered, from front to back. Each channel is drawn on its own layer, which means all channels are independent and can be moved on top of, or behind, other channels.

A dashed line indicates that a part of the channel is behind another channel.



- **Change layer order by dragging the channels.** The left most channel box will appear on top. Drag the channel box to reorder the Z-order of the channels.

### Viewport

Position of the channel frame relative to the video wall. Either type inside the text boxes, or drag your mouse to change the values.

- **X/Y:** Position of channel's top-left corner given in the wall coordinates specified in the Video Wall Dialog. These coordinates can be pixels.
- **W/H:** Width/height of the channel's frame given in the wall coordinates specified in the Video Wall Dialog. These coordinates can be pixels.
- **Reset:** Resets the Viewport values to relocate the channel to the first Active Area of the video wall.

**Tip:** When a GFX channel should not be visible - do not hide them by making them invisible. Instead, shrink the size to 0 (zero) and/or place them outside the visible video wall. The Viz Engine performance can be better when all channels are visible. All channels should be colored in the Channel Bin.

## Crop

Position of the content of the channel relative to the content size. With this control you can perform cropping, shifting and zooming. Any part of the frame which is not filled with content will be transparent. Alternatively, use the [Crop Editor](#) to make these changes.

The **Crop values** in the channel tabs control the cropping. Either type inside the text boxes, or drag your mouse to change the values.

- **Left %/Right %:** Position of channel content's left/right border, relative to the channel frame (positive values push content outside the frame, negative values bring the content inside the frame)
- **Top %/Bottom %:** Position of channel content's top/bottom border, relative to the channel frame
- **Reset:** Resets the Crop values to (0,0,0,0), so that the content fills the frame.

✔ **Tip:** Adjust the **Snapping** and **Keep aspect ratio** settings in order to achieve the precise crop you require.

### Example

In this case, the user has set the crop values in order to shift the entire content to the left by 10%, and zoom in by 5%.



## 4.4.7 Channel Layout Editor

Use the Channel Layout Editor to arrange and resize the channels on your video wall.

⚠ **Note:** Hold **SHIFT** down when resizing the viewports to **scale from center**.

Each channel is drawn on its own layer, which means all channels are independent and can be moved on top of other channels.

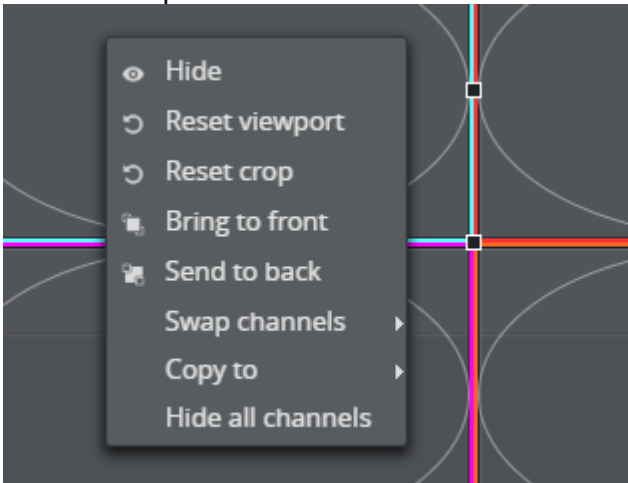

## Context Menu

Right-click a channel to access the context menu:

- **Hide:** Hide this channel from the video wall. To show it again, choose it in the [Channel Bin](#), either by clicking it or dragging it from the Channel Bin onto the video wall surface.
- **Reset viewport:** Reset [Viewport](#) to the first Active Area.
- **Reset crop:** Reset [Crop](#) to (0, 0, 0, 0).
- **Bring to front:** Put this channel in front of the other channels. See [Layer Order](#).
- **Send to back:** Send this channel behind the other channels. See [Layer Order](#).
- **Swap channels:** Select another channel with which to swap all [Viewport](#) and [Crop](#) values.
- **Copy to:** Copies the size and crop values from the channel that was clicked into the channel selected on the context sub menu.
- **Hide All Channels:** Hide all GFX channels.

## Crop Editor

Double-click a channel frame to allow dragging and resizing the channel content, relative to the frame. In this mode, aspect ratio is forced on. Press ESC, or double-click the channel, to exit this mode. Any part of the frame which is not filled with content will be transparent. Alternatively, use the [Crop](#) values in the channel tabs to make these changes.

### Example

In the image below, the user has double-clicked Channel 1 to enter edit mode. They have dragged the handle (left-hand image) and then pressed ESC to see the final result (right-hand image).

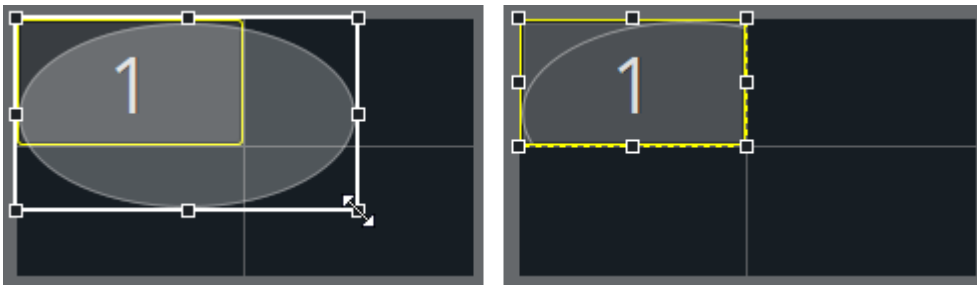

### Animation Between Presets

You can move channels outside the visible area of the video wall area, by dragging them or setting the Viewport values. This allows interesting in/out animations to be made when switching between presets.

#### Example 1

When switching from *Preset\_A* to *Preset\_B* (see diagrams below), channels 2, 3 and 4 become smaller and sweep to the right, off screen, and channel 1 stretches to fill the whole video wall.

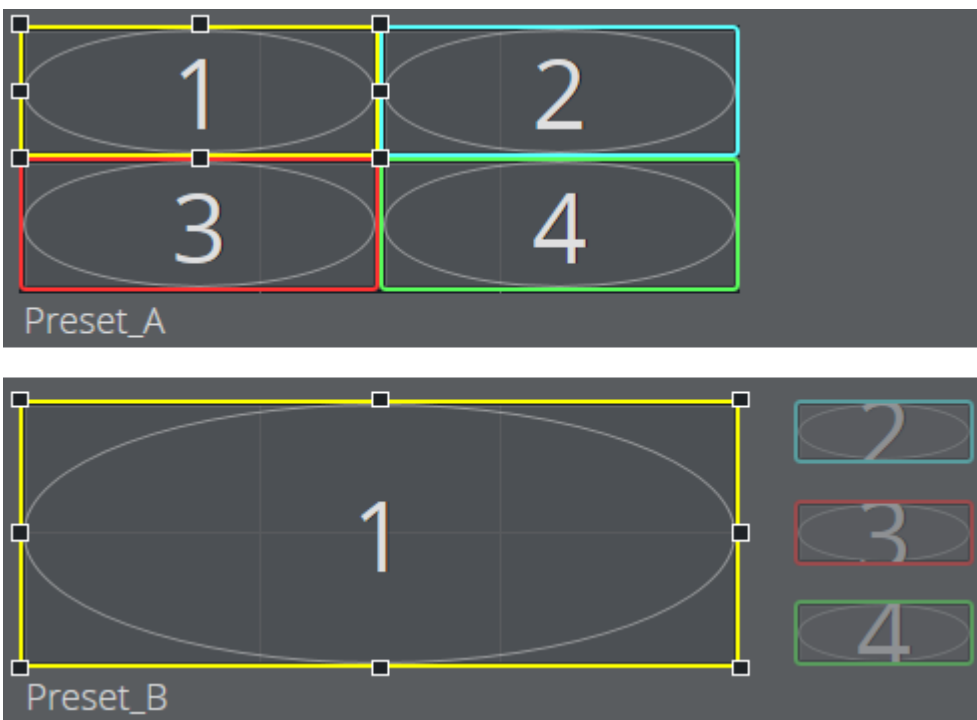

#### Example 2

Animate a channel so that it shrinks into nothing by using the [Viewport](#) settings to set the channel frame width and height to (0, 0).

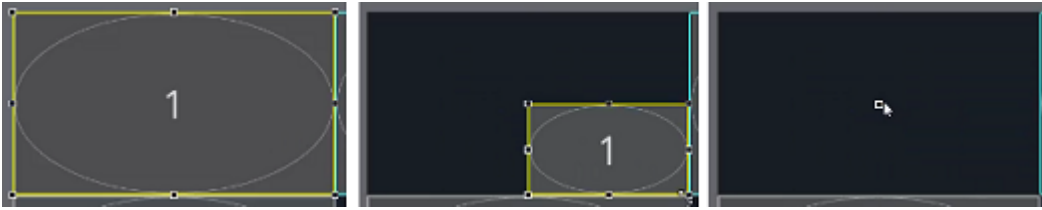

### Example 3

Control the order of the items using the layering of the channels relative to one another. Either right-click a channel frame and select Send to back/Bring to front, or select a channel frame and use the Layer Order buttons.

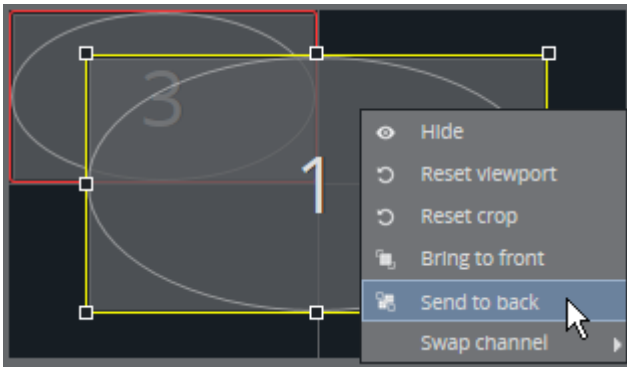

### 4.4.8 Active Areas Editor

In Active Areas mode, the backdrop of the video wall layout can be edited. These areas work as snap points for the GFX channels. They make it easier to create precise GFX channel layouts (presets). The backdrop represents the active areas on the video wall - for instance separate physical screens. When designing a preset, it can be useful to use the active areas to indicate where in the physical world the pixels are located. The Viz Engine draws its output on one surface - but through the use of NVidia Mosaic or the Datapath Fx4 display controller - the pixels from the renderer surface can be mapped to active areas on physical screens.

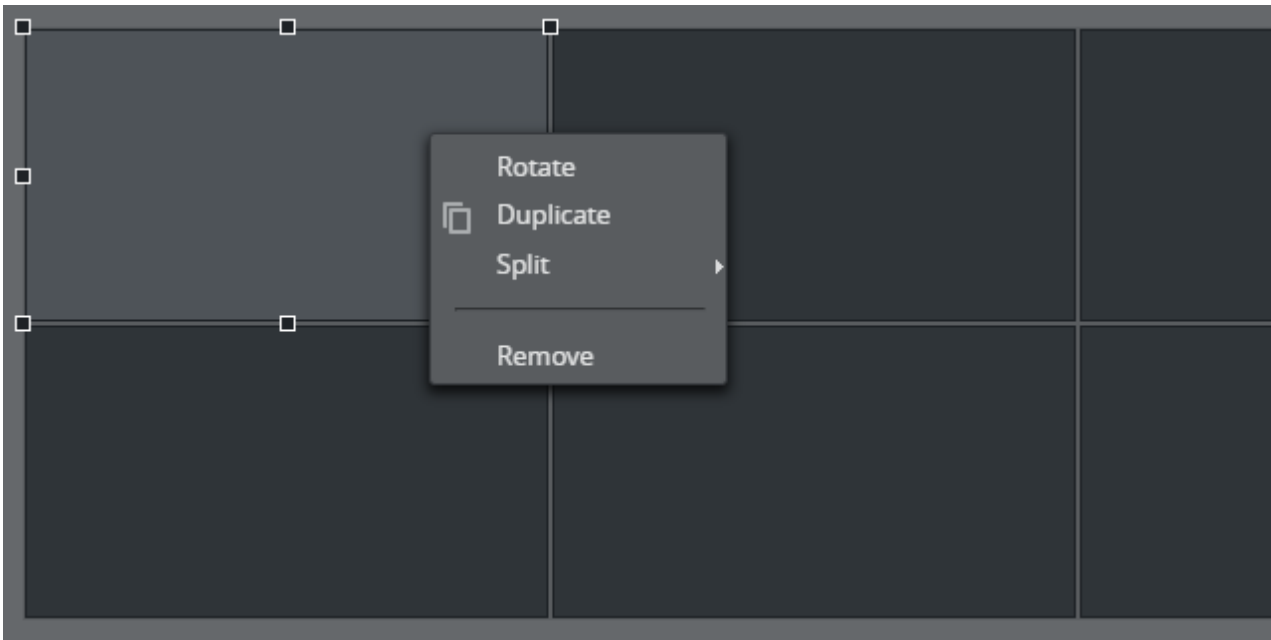

Active Areas in this editor can be created in either of three ways:

1. **Imported from a Datapath Fx4 configuration file.** When using one or more Datapath Fx4 devices, the wall layout from these boxes can be imported into the editor. The backdrop will then have the same layout as the configured layout in the boxes.
2. **Auto generated** based on rows, columns and screen size in the Video Wall dialog. When adding a new video wall in Profile Configuration, it is possible to specify the screen size (normally the resolution), and rows and columns of the screens. This info is used to auto generate a backdrop.
3. **Created from scratch** in the editor. Clear existing areas and start by clicking the plus button down to the right of the editor:

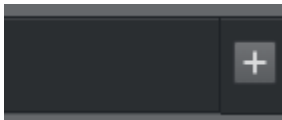

When right-clicking an Active Area, the context menu contains:

- **Rotate:** Rotates the active area 90 degrees. Free rotation is not supported. The content on the wall is not rotated. Only the aspect is changed.
- **Duplicate:** Duplicate the active area.
- **Split:** Split the active area into 2 or 4 new areas.
- **Remove:** Removes the active area.

✓ **Tip:**

- Use the live function to play out either the existing content of the corresponding GFX channel in the Active Areas - or a fill color. This is useful when a part of the renderer output should be mapped to a physical screen.
- Use the arrow keys to fine tune a position.



Active areas can be grouped by clicking and CTRL+ clicking areas, and right-clicking on one of the areas:

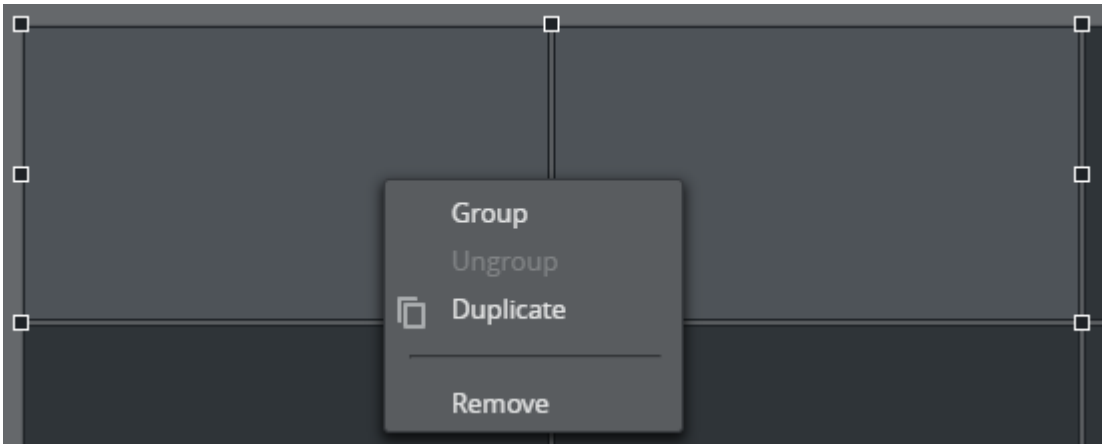

Create a group of the selected areas. The areas can be moved, resized and deleted as one unit. The group number is located at the bottom of the editor:



The highlighted numbers indicate whether a group or an individual Active Area is selected. To toggle between individual selection and group selection - click the active area. Keep an eye on the highlighted numbers and the selection markers around the active areas to see whether the selection contains a group or an Active Area.

✔ **Tip:** It's possible to undo and redo operations in Active Areas mode. The configuration is saved automatically.

---

## 5 Troubleshooting And Known Issues

This section lists tips for troubleshooting and issues that can be useful for the users of the Viz Multiplay application.

 **Note:** To view log messages and version information, go to the [Status Bar](#).

---

### 5.1 Troubleshooting

#### 5.1.1 The Viz Engine Output Keeps Going Black Randomly

If you are using your Viz Engine as a preview server you may see this behavior. Use another Viz Engine to serve out thumbnails.

#### 5.1.2 When I Run Viz Engine in Fullscreen My Graphic Quality Downgrades to SD

This typically happens when using multiple screens. Verify that *Video wall/Multi display* is set correctly in your Viz Engine.

Go to Viz Configuration > Video Output > Video wall/Multi display, and set this to “active”.

#### 5.1.3 Video Transfer from a Search Result to a GFX Channel Stays on 0%

This can happen if Media Sequencer hasn't grabbed the information for asset storage(s).

To resolve this either:

- In Viz Multiplay, go to **Settings > General > Active Profile**, and set it to *No Profile*, and then back to the one you were using. This reinitiates all transfers. Or,
- In Viz Trio, set the pagelist to *inactive*, and then *active* again, which reinitiates all transfers. Then in Viz Trio, confirm that videos can be searched for, added to the playlist and played out.

#### 5.1.4 Video Transfer from a Search Result Gives Errors

ARDFTP and 'No destination available' errors can occur when there is an error with the publishing point in Viz One. Verify that your Viz One can FTP into your Viz Engine.

### 5.1.5 The Search Panel Looks Disabled and It Returns an Error about Viz One

Viz Multiplay can't access Viz One. This could be because there is no network connection to the Viz One, or because there is incorrect host or login information.

In Viz Trio, verify the Viz One configuration by going to "Search Media" and performing a search. In Viz Multiplay, when you get the Viz One popup, use the same credentials as you used in Viz Trio.

### 5.1.6 My Clips/Graphics do not Appear on the Output Engines when I Put Them On Air

Always double check that the elements can be played out from Viz Trio. Also, run the Media Sequencer in a console (not as a service) to get more information on what's wrong when taking elements on air. The messages in the Media Sequencer console are often very useful.

### 5.1.7 No Thumbnails for My Graphics Appear in Viz Multiplay

The Media Sequencer produces the thumbnail URLs for the elements, so it needs to have a Preview Server configured:

1. Go to **Settings > Servers** in Viz Multiplay, and verify that a preview server host is set.
2. When Viz Multiplay is loading, inspect the network traffic in the browser and look for the requests to the Preview Server. Check the HTTP response, which contains an error message.

### 5.1.8 The Show Opens but Doesn't Display Any Stories or Content

If a Viz Trio show contains elements which are not within a group, then they will not be visible in Viz Multiplay. The show may appear empty in Viz Multiplay, even though the Viz Trio show contains elements.

Create a group in the show and move elements into the group.

### 5.1.9 I Have Set up Profiles but Get an Error about No Viz/Video Program

The error may look like *"No Viz/video program for this entry. Please check the Viz/video program output configuration"*.

This means that an element has been added to a channel that does not support it (e.g. adding video to a graphics channel or vice versa). This can also occur if a profile is selected which does not have a program channel. Also try to deactivate the profile and reactivate it again.

### 5.1.10 Problems Running Preview Server

To troubleshoot the Preview Server, go to the debug page for the Media Sequencer on [http://mse\\\_host:8580/debug](http://mse\_host:8580/debug) and browse to your show elements. Do you see thumbnails on this page? If not, click on the thumbnail and you will get an error message. You can also inspect the network traffic in the browser (in Chrome and Firefox by pressing F12 and going to 'Network') when

loading the show in Viz Multiplay. Inspect the HTTP response of the broken Preview Server requests. This should give you a hint as to where the problem lies.

---

## 5.2 Known Issues In Viz Multiplay

- Thumbnails for graphics with video texture will only display the graphic.
  - Running Cleanup also cleans up the Presets scene. Therefore, after a cleanup, you must run a Preset before running other elements. To do this, click on a Preset.
  - Do not initialize while On Air, as this can result in a lag in the graphics output.
  - If a playlist is activated by a Viz Trio client, then it will be deactivated if that Viz Trio client shuts down, and Viz Multiplay will lose its active profile. Always set the Active Profile for a playlist in Viz Multiplay.
  - Viz Multiplay does not support videos with overlay graphics as a timeline. To display graphics on top of videos, place GFX channels on top of each other and play elements manually in each channel.
  - Using color correction together with a bezel in the NVIDIA Mosaic setup requires Viz Engine 3.8.3.
- 

## 5.3 Performance Issues

This section covers the following topics:

- DynamicChannel scene
- Video wall setup
- Background loading of images (performance)

### 5.3.1 DynamicChannel Scene

The DynamicChannel scene must be seen as a template. It should not be used in the distributed version. It must be modified by a Viz Artist expert on location to match the customer system.

This will improve performance significantly:

- In DynamicChannel, disable or preferably remove all GFX channels not in use. (The default DynamicChannels scene has 16 GFX channels, of which 8 are disabled.)

**In addition, during the playout situation:**

Before going on air, "warm up" (take) all the scenes that are going to be taken. Initializing is often not enough. Scenes should be taken on air and out again at least once on their GFX channel. The next time they are taken, Viz Engine displays them without affecting the overall performance.

Always take a preset on air before the show starts. Never take presets out. There should always be a preset on air.

### 5.3.2 Video Wall Setup

Configuring a video wall setup is not straight forward. Make sure you read and follow [this advice](#).

✓ **Tip:** There are many factors impacting the performance of a video wall driven by one Viz Engine, so try experimenting and fine tune the setup with real content and real constraints.

### 5.3.3 Background Loading of Images (Performance)

Support for background loading of images was added in Multiplay 2.2.

⚠ **Note:** This is unrelated to the general config setting enabling background loading in Viz Config.

This fixes a bug that froze the video wall for notable periods. This arose when a fullscreen image was added to a show and taken to air without initializing it first. While downloading the image, the Viz Engine would then block the renderer and render the image, causing the wall to freeze.

### 5.3.4 Requirements

- Background loading of images requires the latest official Viz 3.8.3.62368 build (or later) on the official [FTP](#).
- The #13 version (the scene version bundled with Multiplay 2.2) of the DynamicChannels scene must be present in Graphic Hub.

⚠ **Note:** Images from an HTTP resource (Viz One and Media Service) can still cause a small frame drop in the renderer, but at least the renderer will download it in the background and not block for a long period.

### 5.3.5 Preparation of Images in Graphic Hub

Images from Graphic Hub should not cause any frame drop in the renderer if they are background-loading compatible. This means they should be DXT1 or DXT5 compressed images.

To check whether a GH image is background loading compatible:

1. Open Viz Artist, locate it in the server tree.
2. Right-click the image and choose **Check for Background Loading**.

To make a GH image background loading compatible:

1. Open Viz Artist, locate it in the server tree.
2. Open the image by double-clicking it.
3. Choose **Convert Format** in the left menu.
4. Choose **DXT1** or **DXT5** in the menu that appears.
5. Save it.

---

## 6 FAQs

- How do I set up a video wall with screens with different aspects and resolutions?
- Does Viz Multiplay support clips with non broadcast format?
- Can I use Viz Pilot instead of Viz Trio?
- What is the technical limitation of playing HD clips?
- Does the playlist update after changes in the newsroom system rundown?
- Can Viz Multiplay play out graphics created via Viz Pilot templates?
- Can Viz Multiplay open a playlist from Viz Pilot?
- Can Viz Multiplay open a MOS rundown? What is the workflow?
- How do I run movie clips?
- Can we have live input in one of the monitors or across a group?
- Can I use a touch screen monitor in my live-to-air control room?
- Can Viz Multiplay be controlled by Viz Mosart, VDCP, Viz Trio or Viz Pilot?
- Can Viz Multiplay be integrated into a Mosart workflow?
- Can we use Social TV as a source for Viz Multiplay?
- Do I need a Viz One to feed Viz Multiplay with clips and images?

---

### 6.1 How Do I Set Up A Video Wall With Screens With Different Aspects And Resolutions?

The easiest way is to use an external video wall display controller like Datapath Fx4. These controllers accept up to 4K input and 4 outputs. With Nvidia Mosaic up to 4 outputs from the GPU can be combined and split up with Datapath Fx4 display controllers.

---

### 6.2 Does Viz Multiplay Support Clips With Non Broadcast Format?

Videos in Viz Multiplay are limited to the broadcast formats and aspects supported by the clip channels in Viz Engine.

#### Can I assign GFX channels to different aspects?

If a GFX channel is only used to play out elements with a special aspect - like portrait images, it is possible to set the aspect for this channel. Then thumbnails and GFX channels in the Video Wall designer will respect this aspect. This will not affect playout in any way - only how the elements are displayed in the Multiplay GUI.

#### Do I need Viz Trio or Viz Pilot to set up Viz Multiplay?

If you are using Viz Multiplay for clips and images only, you can do without.

However Viz Trio or Viz Pilot *is* required if you need to import and play out graphics from a Viz Engine.

---

## 6.3 Can I Use Viz Pilot Instead Of Viz Trio?

Yes!

---

## 6.4 What Is The Technical Limitation Of Playing HD Clips?

The technical limitation of the number of channels is 16, depending on the video board. The performance when playing a number of clips is dependent of lot of different factors, like the hardware and the clip codecs and formats. Real life tests should always be conducted before going into production.

---

## 6.5 Does The Playlist Update After Changes In The Newsroom System Rundown?

Yes. It is the Media Sequencer that communicates through the MOS protocol with the newsroom system (ENPS, iNews etc.). Any update is handled by the Media Sequencer, and the playlist in Viz Multiplay will automatically display the changes.

---

## 6.6 Can Viz Multiplay Play Out Graphics Created Via Viz Pilot Templates?

Yes. Create a Viz Pilot rundown with the graphics, images and videos you want to play out. The playlist will automatically be available in Viz Multiplay.

---

## 6.7 Can Viz Multiplay Open A Playlist From Viz Pilot?

Yes. Add the playlist to the show with the Add button on the Show pane. Once open in Viz Multiplay, the playlist updates dynamically, as it is changed in Viz Pilot.

Click the **Add (+)** button in the [Show Pane](#) to open an existing external playlist.

---

## 6.8 Can Viz Multiplay Open A MOS Rundown? What Is The Workflow?

Yes, you can add any external playlist to the show - so both the show and the added playlist(s) are available in Viz Multiplay. In this way the user can, for example, have a show with video wall presets and other more permanent elements, and add a MOS rundown or a Viz Pilot rundown to this show to make the MOS/Viz Pilot elements available too.

## 6.9 How Do I Run Movie Clips?

Simply click or tap them and they will either be armed or played directly on air.

---

## 6.10 Can We Have Live Input In One Of The Monitors Or Across A Group?

Yes. Custom scenes with a live input source must be created in Viz Artist and imported by Viz Trio as regular pages. These pages can be placed in the inbox show and then dragged into any channel.

---

## 6.11 Can I Use A Touch Screen Monitor In My Live-To-Air Control Room?

Viz Multiplay can easily be operated for playout on touch devices, but it is not advisable to do editing on them. We have found Firefox to have the best touch screen experience when using Viz Multiplay.

---

## 6.12 Can Viz Multiplay Be Controlled By Viz Mosart, VDCP, Viz Trio Or Viz Pilot?

Not really. The Media Sequencer does not support detecting the last taken element per channel. This means that even though a playlist can be controlled by external triggering or a control client, Viz Multiplay will not detect elements taken on air, and the elements will not show up in the Program or Armed column.

---

## 6.13 Can Viz Multiplay Be Integrated Into A Mosart Workflow?

Ye. It requires some manual steps. Basically it is possible to create video wall presets in Multiplay and play them out as Pilot elements in a Mosart rundown. Contact Vizrt Support for more information.

---

## 6.14 Can We Use Social TV As A Source For Viz Multiplay?

Yes. Social TV creates regular Viz Trio pages in a show that can be opened or used as an inbox in Viz Multiplay, so the elements can be controlled by Viz Multiplay.



## 6.15 Do I Need A Viz One To Feed Viz Multiplay With Clips And Images?

We do recommend having a Viz One or a Media Service installed and configured on the Media Sequencer. It is also possible to use a Graphic Hub REST service as a source for images.